

**MİMARİ SİSTEMLER KATALOĞU/2023**  
ARCHITECTURAL SYSTEMS CATALOGUE  
**CEPHE SİSTEMLERİ**







MEKA  
LINE

www.mekaline.com.tr

Hakkımızda / About us



Firmamız **Mekaline Alüminyum** 1992 yılında alüminyum ekstrüzyon kalıp sektörü ile işe başlayıp her geçen gün gelişerek kalite ve üretimini arttırarak alüminyum profil üretimi ile yoluna devam etmektedir. Yeni ve modern teknoloji ile donatılmış tesisimiz 40.000 m2 üzerine kurulmuş olup, 30.000 m2 kapalı alan içerisinde üretimine devam etmektedir.

Haziran 2011 Tarihinde 1100 tonluk alüminyum pres hattı,2015 yılında ise 1600 tonluk pres hattını devreye alarak Adana Hacı Sabancı Organize Sanayi Bölgesinde faaliyetlerine başlamıştır.

Entegre yönetim sistemi ile uluslararası kalite standartlarında üretim yapmakta, güvenilir satış politikası ile müşteri taleplerine hızlı ve ekonomik çözümler sunmaktadır.

10.000 ton üretim kapasiteli dikey elektrostatik boyama hattı, 600 ton kapasiteli ahşap kaplama hattı, 12.000 ton kapasiteli eloksal yüzey kaplama hattına sahiptir.

Tesisimiz kalıp ihtiyacını kendi bünyesinde karşılamakta olup 12.000 binin üzerinde olan ürün çeşitliliği ile İnşaat, Mobilya ve Reklam, Otomotiv, Enerji, Elektrik-Elektronik, Sektörlerinde faaliyet göstermektedir, ayrıca müşterilerimizin taleplerine yönelik de hizmet vermekte olup, yüksek kalitede hizmetini sürdürmektedir.

Firmamız bu kalite ile yetinmeyip daha yüksek yerler hedefleyerek yılların vermiş olduğu bilgi ve deneyimli kadrosu ile en üst düzeyde teknolojiyi kullanarak en güzel hizmeti verebilmenin gayreti içerisinde.

*Our company, **Mekaline Aluminum**, started to work in the aluminum extrusion mold sector in 1992 and continues its way with aluminum profile production by increasing its quality and production day by day. Our facility, equipped with the new and modern technology, was established on 40.000 sqm and continues its production in a closed area of 30.000 sqm.*

*It started its activities in Adana Hacı Sabancı Organize Sanayi Bölgesi by putting into use 1100 tons of aluminum press line in June 2011 and 1600 tons of press line in 2015.*

*It produces in international quality standards with its integrated management system and it offers fast and economical solutions to customer demands with the reliable sales policy.*

*It has a vertical electrostatic painting line with a production capacity of 10,000 tons, a wood coating line with a capacity of 600 tons, an anodized surface coating line with a capacity of 12,000 tons.*

*Our facility meets the mold needs within its own structure, and it operates in the Construction, Furniture and Advertising, Automotive, Energy, Electric-Electronics Sectors with its product range of over 12,000 thousand, and also provides services for the demands of our customers and maintains its high quality service.*

*Our company strives to provide the best service by using the highest level of technology with the knowledge and experienced staff of years, by targeting higher places because it is not satisfied with this quality.*







<b>MK CEPHE 50 / MK FACADE 50</b> .....	<b>5-94</b>
- PROFİL KESİT DETAYLARI / PROFILE DETAILS DRAWINGS .....	<b>31-76</b>
- KAPAKLI DETAYLAR / COVERED DETAILS .....	<b>77-90</b>
- SİLİKON DETAYLAR / SILICONE DETAILS .....	<b>91-94</b>
<b>MK CEPHE 65 ÇELİK TAKVİYELİ C. S. / F. S. WITH STEEL REINFORCEMENT</b> .....	<b>95-114</b>
- SİSTEM DETAYLARI / SYSTEM DETAILS .....	<b>101-104</b>
<b>GÜNEŞ KIRICI SİSTEMLERİ / SOLAR SHADING SYSTEMS</b> .....	<b>115-142</b>
- PROFİL KESİT DETAYLARI / PROFILE DETAILS DRAWINGS .....	<b>123-138</b>
- SİSTEM DETAYLAR / SILICONE DETAILS .....	<b>139-142</b>
<b>KOMPOZİT PANEL PROFİLLERİ / COMPOSITE PANEL PROFILES</b> .....	<b>143-165</b>
- PROFİL KESİT DETAYLARI / PROFILE DETAILS DRAWINGS .....	<b>151-160</b>
- SİSTEM DETAYLAR / SILICONE DETAILS .....	<b>161-165</b>

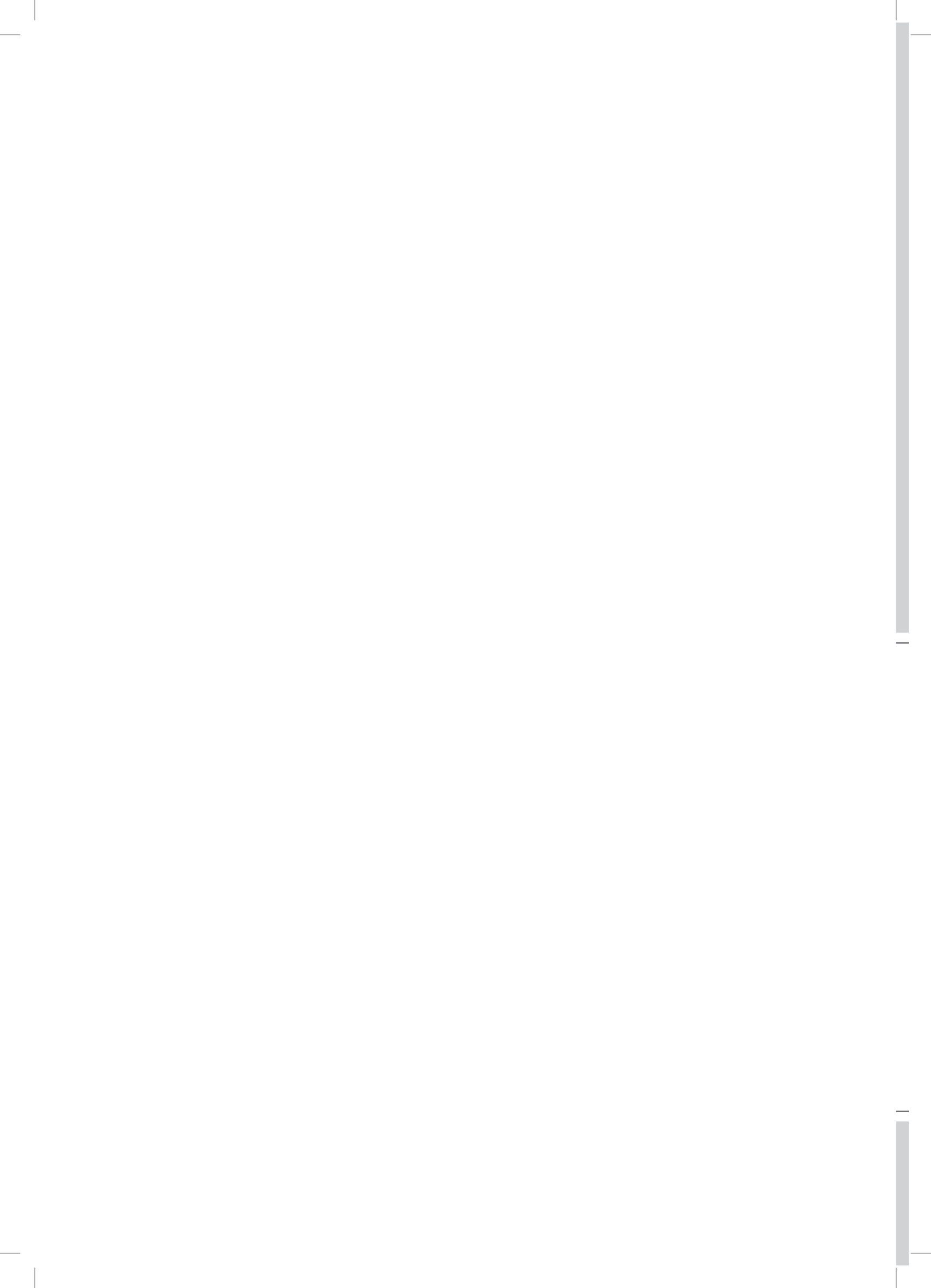



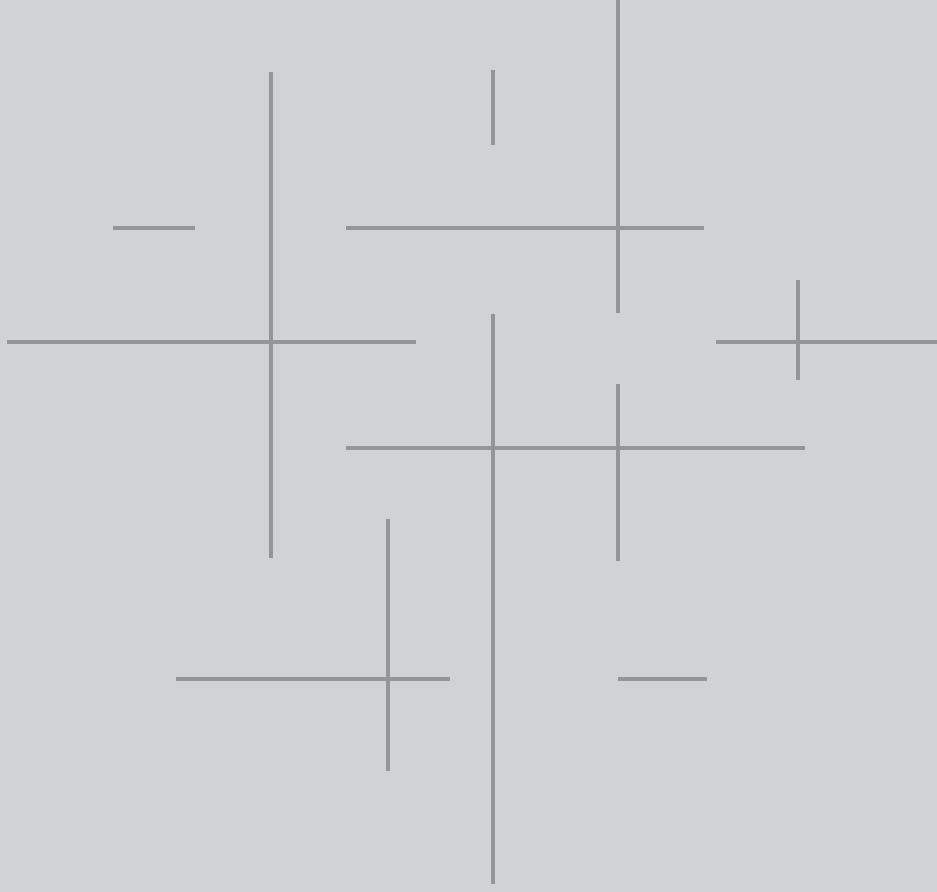

## **MK CEPHE 50**

MK FACADE 50

**31-76**

**PROFİL KESİT DETAYLARI**  
PROFILE DETAILS DRAWINGS

**91-94**







**SİLİKON DETAYLAR**  
SILICONE DETAILS

**77-90**

**KAPAKLI DETAYLARI**  
COVERED DETAILS



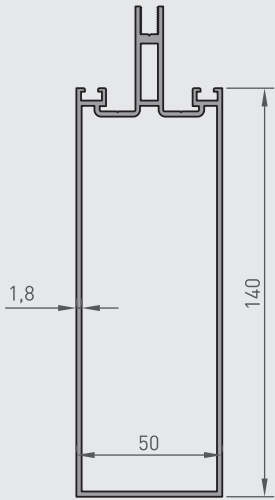
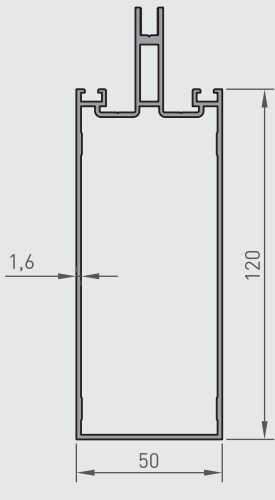

# MK CEPHE 50

## MK FACADE 50

ŞEKİL DRAWING	KOD CODE	 mm	 mm	 cm <sup>4</sup>	 cm <sup>4</sup>	 kg/m
	<b>1079</b>	50.00	168.00	245.66	33.49	2.300
	<b>1078</b>	50.00	148.00	159.69	26.94	1.930
	<b>1077</b>	50.00	148.00	179.93	30.70	2.210



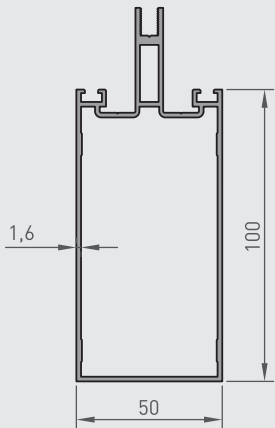
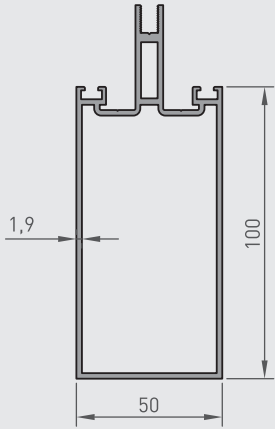
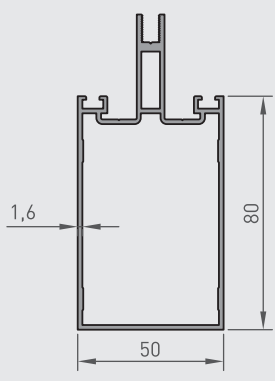

# MK CEPHE 50

## MK FACADE 50

ŞEKİL DRAWING	KOD CODE	 mm	 mm	 cm <sup>4</sup>	 cm <sup>4</sup>	 kg/m
	<b>1018</b>	50.00	128.00	106.00	23.19	1.750
	<b>1062</b>	50.00	128.00	119.36	26.30	2.005
	<b>1059</b>	50.00	108.00	65.54	19.44	1.580

# MK CEPHE 50



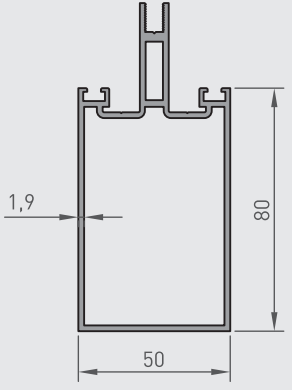
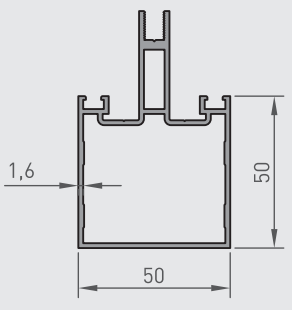

## MK FACADE 50

ŞEKİL DRAWING	KOD CODE	 mm	 mm	 cm <sup>4</sup>	 cm <sup>4</sup>	 kg/m
	<b>1064</b>	50.00	108.00	73.47	21.90	1.800
	<b>1017</b>	50.00	78.00	26.05	13.81	1.320





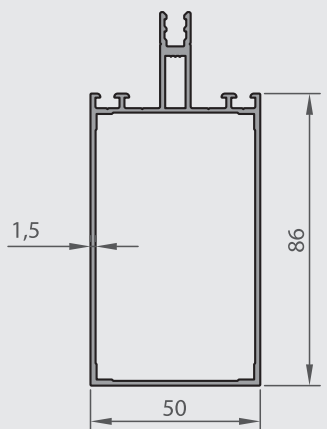
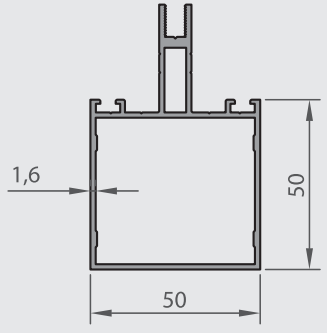
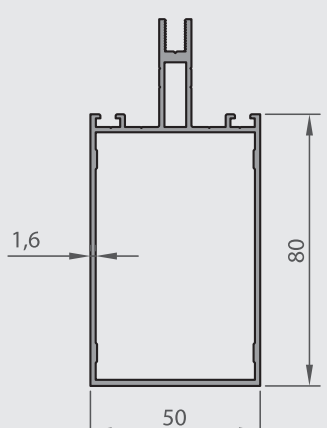

# MK CEPHE 50

## MK FACADE 50

ŞEKİL DRAWING	KOD CODE	 mm	 mm	 cm <sup>4</sup>	 cm <sup>4</sup>	 kg/m
	<b>1057</b>	50.00	110.00	65.47	18.90	1.425
	<b>1000-230</b>	50.00	78.00	25.85	13.16	1.235
	<b>1000-231</b>	50.00	108.00	68.03	19.08	1.525



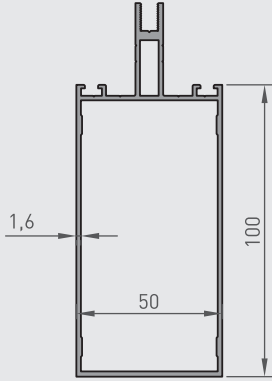
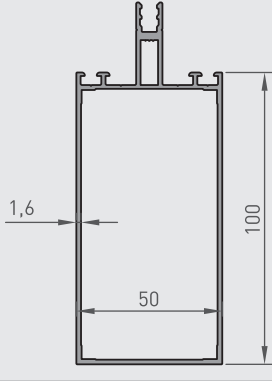
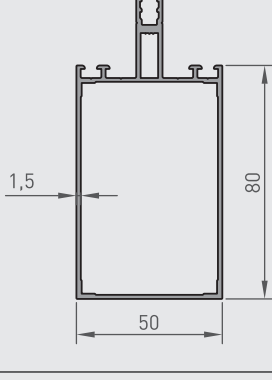
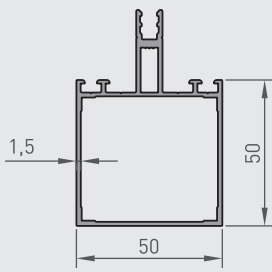

# MK CEPHE 50

## MK FACADE 50

ŞEKİL DRAWING	KOD CODE	 mm	 mm	 cm <sup>4</sup>	 cm <sup>4</sup>	 kg/m
	<b>1000-232</b>	50.00	128.00	109.21	22.92	1.700
	<b>1000-199</b>	50.00	124.00	22.36	95.23	1.620
	<b>1000-200</b>	50.00	104.00	17.83	55.97	1.390
	<b>1000-201</b>	50.00	74.00	12.54	21.30	1.145



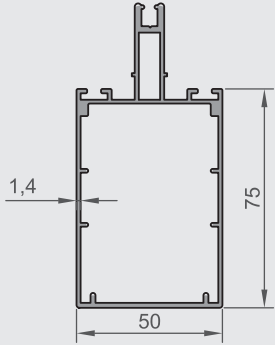
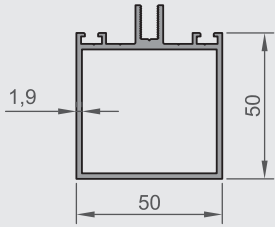
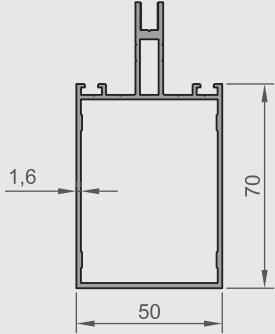
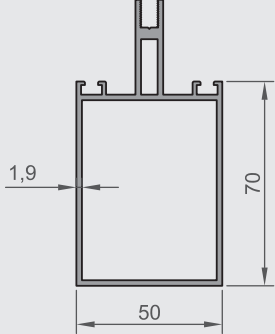

# MK CEPHE 50

## MK FACADE 50

ŞEKİL DRAWING	KOD CODE	 mm	 mm	 cm <sup>4</sup>	 cm <sup>4</sup>	 kg/m
	<b>1033</b>	50.00	104.30	61.13	18.05	1.500
	<b>1092</b>	50.00	59.50	17.15	14.57	1.180
	<b>1090</b>	50.00	98.00	50.98	16.78	1.430
	<b>1091</b>	50.00	98.00	55.85	19.11	1.625

# MK CEPHE 50



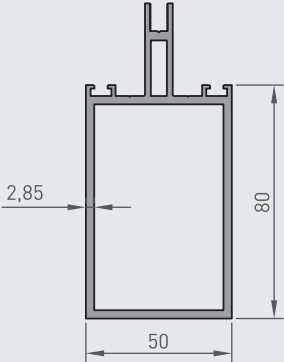
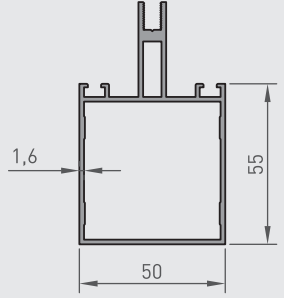
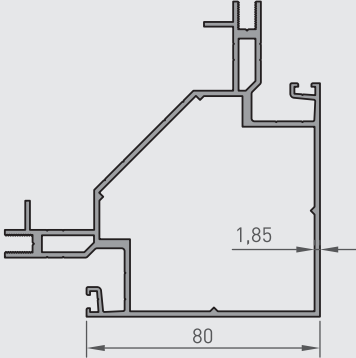
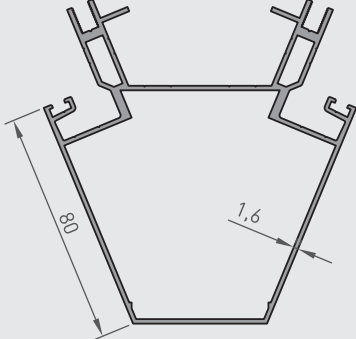

## MK FACADE 50

ŞEKİL DRAWING	KOD CODE	 mm	 mm	 cm <sup>4</sup>	 cm <sup>4</sup>	 kg/m
	1093	50.00	108.00	93.21	29.70	2.315
	1089	50.00	83.00	31.46	14.27	1.315
	1080	108.00	108.00	135.77	63.46	2.540
	1081	107.13	111.16	99.38	92.78	2.355





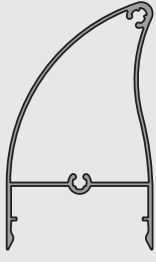
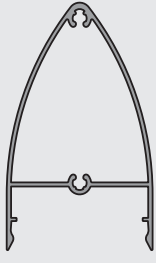
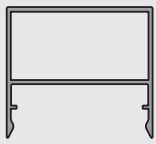
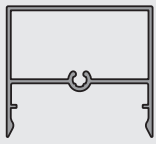

# MK CEPHE 50

## MK FACADE 50

ŞEKİL DRAWING	KOD CODE	 mm	 mm	 cm <sup>4</sup>	 cm <sup>4</sup>	 kg/m
	<b>1030</b>	50.00	84.80	24.77	10.23	0.945
	<b>1094</b>	50.00	85.00	22.79	11.60	0.990
	<b>1000-262</b>	50.00	45.00	10.45	5.00	0.745
	<b>1095</b>	50.00	45.00	10.34	5.08	0.760



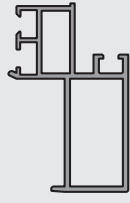
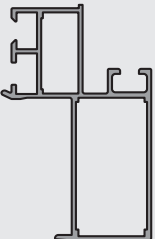
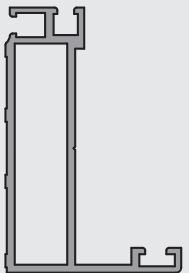

# MK CEPHE 50

## MK FACADE 50

ŞEKİL DRAWING	KOD CODE	 mm	 mm	 cm <sup>4</sup>	 cm <sup>4</sup>	 kg/m
	<b>1019</b>	35.80	55.50	9.83	2.32	0.830
	<b>1000-266</b>	35.80	55.50	22.79	11.60	0.620
	<b>1024</b>	33.15	50.00	7.37	1.41	0.625



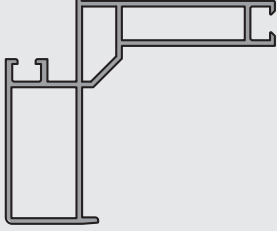
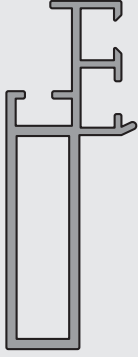

# MK CEPHE 50

## MK FACADE 50

ŞEKİL DRAWING	KOD CODE	 mm	 mm	 cm <sup>4</sup>	 cm <sup>4</sup>	 kg/m
	<b>1023</b>	67.00	56.30	21.22	4.78	1.020
	<b>1053</b>	21.00	56.30	6.49	0.60	0.605

# MK CEPHE 50



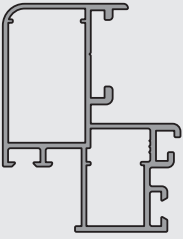
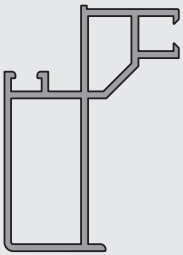
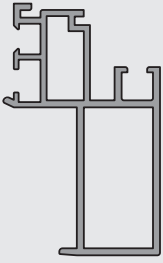
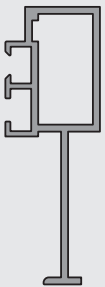

## MK FACADE 50

ŞEKİL DRAWING	KOD CODE	 mm	 mm	 cm <sup>4</sup>	 cm <sup>4</sup>	 kg/m
	<b>1056</b>	40.60	52.10	8.41	3.02	0.790
	<b>1063</b>	39.80	56.10	11.26	2.35	0.830
	<b>1082</b>	33.40	57.50	10.83	2.47	0.875
	<b>1083</b>	21.60	63.40	7.96	0.90	0.630







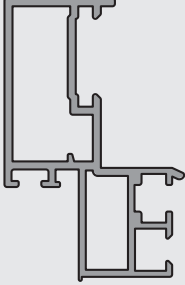
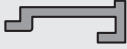
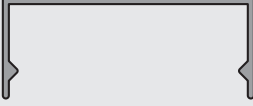
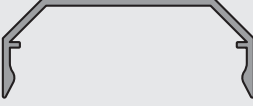



# MK CEPHE 50

## MK FACADE 50

ŞEKİL DRAWING	KOD CODE	 mm	 mm	 cm <sup>4</sup>	 cm <sup>4</sup>	 kg/m
	<b>1000-260</b>	35.80	56.30	14.24	1.97	0.870
	<b>1084</b>	14.90	5.20			0.075
	<b>1052</b>	50.00	20.00			0.315
	<b>1096</b>	50.00	19.80			0.330

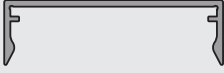
# MK CEPHE 50

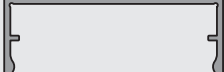
## MK FACADE 50

ŞEKİL DRAWING	KOD CODE	 mm	 mm	 cm <sup>4</sup>	 cm <sup>4</sup>	 kg/m
	<b>1098</b>	50.00	14.80			0.325
	<b>1099</b>	46.90	10.00			0.395
	<b>1097</b>	50.00	19.80			0.360
	<b>1029</b>	17.00	14.00			0.250
	<b>1085</b>	23.00	5.00			0.185

# MK CEPHE 50

## MK FACADE 50

ŞEKİL DRAWING	KOD CODE	 mm	 mm	 cm <sup>4</sup>	 cm <sup>4</sup>	 kg/m
	<b>1088</b>	22.00	11.20			0.320
	<b>1000-137</b>	17.95	9.30			0.185
	<b>1000-175</b>	17.95	9.30			0.180





# MK CEPHE 50

## MK FACADE 50

ŞEKİL DRAWING	KOD CODE	 mm	 mm	 cm <sup>4</sup>	 cm <sup>4</sup>	 kg/m
	<b>516</b>	25.00	5.00			0.130
	<b>517</b>	21.60	4.20			0.130
	<b>1042</b>	19.40	4.30			0.135
	<b>1000-189</b>	23.30	4.40			0.110
	<b>1043</b>	45.70	134.60	213.83	31.54	3.030



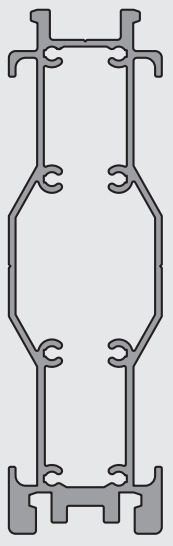

# MK CEPHE 50

MK FACADE 50

ŞEKİL DRAWING	KOD CODE	 mm	 mm	 cm <sup>4</sup>	 cm <sup>4</sup>	 kg/m
	<b>1000-116</b>	45.70	156.50	390.41	31.59	36.75





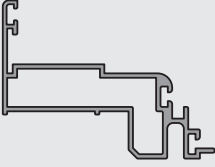
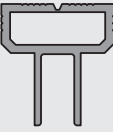
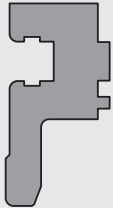
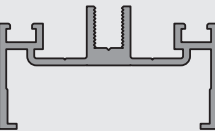
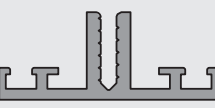



# MK CEPHE 50

## MK FACADE 50

ŞEKİL DRAWING	KOD CODE	 mm	 mm	 cm <sup>4</sup>	 cm <sup>4</sup>	 kg/m
	<b>1000-103</b>	72.60	54.20	25.00	3.00	1.075
	<b>1000-104</b>	19.30	20.80			0.260
	<b>1000-105</b>	13.20	25.70			0.515
	<b>1000-106</b>	50.00	28.00			0.690
	<b>1000-107</b>	50.00	20.00			0.780



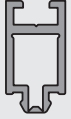

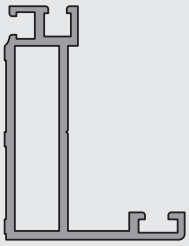
# MK CEPHE 50

## MK FACADE 50

ŞEKİL DRAWING	KOD CODE	 mm	 mm	 cm <sup>4</sup>	 cm <sup>4</sup>	 kg/m
	<b>1000-108</b>	21.60	39.30			0.415
	<b>1000-109</b>	36.00	61.00			0.640
	<b>1000-110</b>	10.00	19.10			0.190
	<b>1000-111</b>	10.00	17.80			0.220
	<b>1000-112</b>	30.85	40.00	3.96	0.96	0.515

# MK CEPHE 50



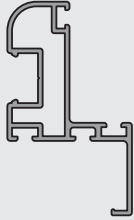
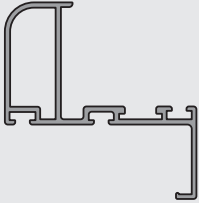
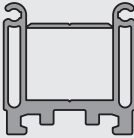
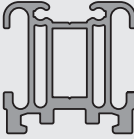
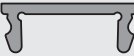





## MK FACADE 50

ŞEKİL DRAWING	KOD CODE	 mm	 mm	 cm <sup>4</sup>	 cm <sup>4</sup>	 kg/m
	<b>1000-113</b>	42.70	73.20	16.94	3.64	1.025
	<b>1000-115</b>	65.60	67.30	26.37	4.91	1.085
	<b>1000-263</b>	45.20	45.00			1.570
	<b>1000-117</b>	45.20	45.00			1.745
	<b>1000-114</b>	16.70	6.00			0.095

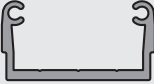

# MK CEPHE 50

MK FACADE 50

ŞEKİL DRAWING	KOD CODE	 mm	 mm	 cm <sup>4</sup>	 cm <sup>4</sup>	 kg/m
	<b>1000-118</b>	32.60	6.50			0.330
	<b>1000-119</b>	45.70	23.55			0.690
	<b>1020</b>	45.70	28.55			0.865



# MK CEPHE 50

## MK FACADE 50

AKSESUAR ACCESSORY	SİPARİŞ KODU ORDER CODE	PAKET ADET UNITS	AKSESUAR ACCESSORY	SİPARİŞ KODU ORDER CODE	PAKET ADET UNITS
 CEPHE KAPAK FİTİLİ	<b>MK-16</b>	<b>165 m</b> 75 gr/m	 CAM CEPHE FİTİLİ	<b>MK-37</b>	<b>190 m</b> 65 gr/m
 YARIM KAPAK FİTİLİ	<b>MK-27</b>	<b>50 m</b> 195 gr/m	 CAM CEPHE FİTİLİ	<b>MK-40</b>	<b>125 m</b> 95 gr/m
 CEPHE ORTA FİTİLİ	<b>MK-64</b>	<b>200 m</b> 50 gr/m	 KULAKLI FİTİL	<b>MK-32</b>	<b>185 m</b> 65 gr/m
 BİNİ FİTİLİ	<b>MK-21</b>	<b>450 m</b> 30 gr/m	 CAM CEPHE FİTİLİ	<b>MK-51</b>	<b>220 m</b> 55 gr/m
 CAM CEPHE FİTİLİ	<b>MK-17</b>	<b>220 m</b> 60 gr/m	 CAM CEPHE FİTİLİ	<b>MK-52</b>	<b>200 m</b> 60 gr/m

# MK CEPHE 50

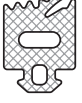
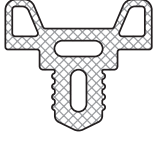
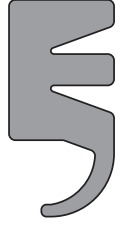





## MK FACADE 50

AKSESUAR ACCESSORY	SİPARİŞ KODU ORDER CODE	PAKET ADET UNITS
 CAM CEPHE FİTİLİ	<b>MK-53</b>	<b>150 m</b> 80 gr/m
 CAM CEPHE FİTİLİ	<b>MK-54</b>	<b>130 m</b> 90 gr/m
 CEPHE ORTA FİTİLİ	<b>MK-19</b>	<b>60 m</b> 175 gr/m
 CEPHE SABİTLEME TAKOZU	<b>MK-004</b>	
 CAM CEPHE DIŞ FİTİLİ	<b>MK-18</b>	<b>170 m</b> 70 gr/m

# MK CEPHE 50

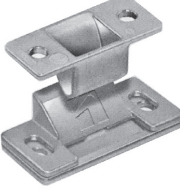
## MK FACADE 50



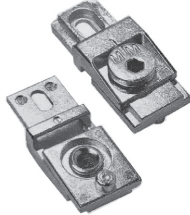

### AKSESUARLAR / ACCESSORIES

AKSESUAR ACCESSORY	SİPARİŞ KODU ORDER CODE	PAKET ADET UNITS	AKSESUAR ACCESSORY	SİPARİŞ KODU ORDER CODE	PAKET ADET UNITS
 TERS VASİSTAS MAKAS	MK STORMB10		 KOL ADAPTÖRÜ	MK STL1406	
	MK STORMB12			MK STL1410	
	MK STORMB16			MK STL1506	
	MK STORMB22			MK STL1510	
	MK STORMB26			MK STL1606	
 PARALEL MAKAS	MK PARALEL PLUS		 KASET ÜST BASKI APARATI	MK S8305	
				MK R8304	
 TERS VASİSTAS MAKAS	MK STERLING		 KOL	MK VIRAGE WINDOW HANDLES	
 90° AÇILIM MAKAS	MK STORMBS10		 MAKAS AYAR KLİPSİ	MK S7280	
	MK STORMBS16				

# MK CEPHE 50

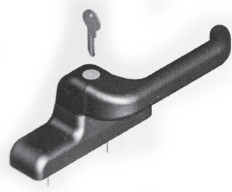
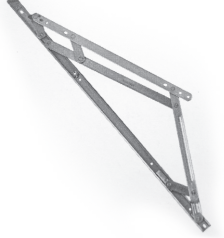
## MK FACADE 50

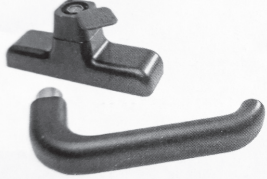
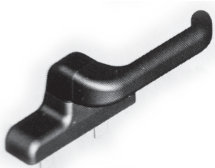



### AKSESUARLAR / ACCESSORIES

AKSESUAR ACCESSORY	SİPARİŞ KODU ORDER CODE	PAKET ADET UNITS	AKSESUAR ACCESSORY	SİPARİŞ KODU ORDER CODE	PAKET ADET UNITS
 PARALEL MAKAS	MK 01990000		 KIVRIM KOL (KEY ANAHTARLI)	MK 05008	
 TERS VASİSTAS MAKAS	MK GS HD-10"P TİPİ	08534000N	 KIVRIM KOL (ÇİFT MAÇA)	MK 01170N	
	GS HD-12"P TİPİ	08535000N			
	GS HD-14"P TİPİ	08536000N			
	GS HD-16"P TİPİ	08537000N			
	GS HD-18"P TİPİ	08538000N			
	GS HD-20"P TİPİ	08539000N			
	GS HD-22"P TİPİ	08540000N			
	GS HD-24"P TİPİ	08541000N			
 PARALEL MAKAS	MK 01991		 EKSENEL KOL	MK 01001	
 KIVRIM KOL	MK 05007		 KİLİTLİ KOL	MK 01192	
 LİMİTLEME MAKASI	LAZER 2 KADEMELİ TELESKOPIK MAKAS MK 01951			MK 01954	

# MK CEPHE 50

## MK FACADE 50

### AKSESUARLAR / ACCESSORIES

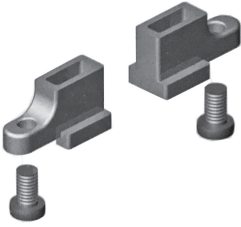
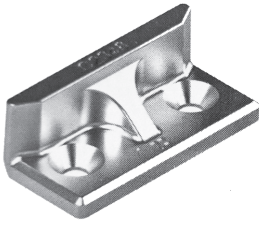
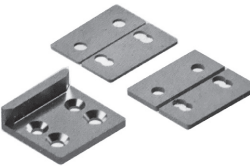
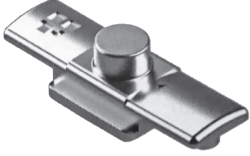
AKSESUAR ACCESSORY	SİPARİŞ KODU ORDER CODE	PAKET ADET UNITS	AKSESUAR ACCESSORY	SİPARİŞ KODU ORDER CODE	PAKET ADET UNITS
 KÖŞE DÖNME	MK 04019K		 AYARLI PİM	MK 04030 MK 04682	
 KÖŞE DÖNME	MK 04020K		 ÜST KİLİTLEME ELEMANI	MK 01374	
 BAĞLANTI ELEMANI	MK 02236 MK 02262		 KİLİTLİ KARŞILIK	MK 01214	
 SABİT KARŞILIK	MK 01266K MK 01267 MK 01268		 KİLİT PİMİ VE KİLİT KARŞILIK	MK 04047K	

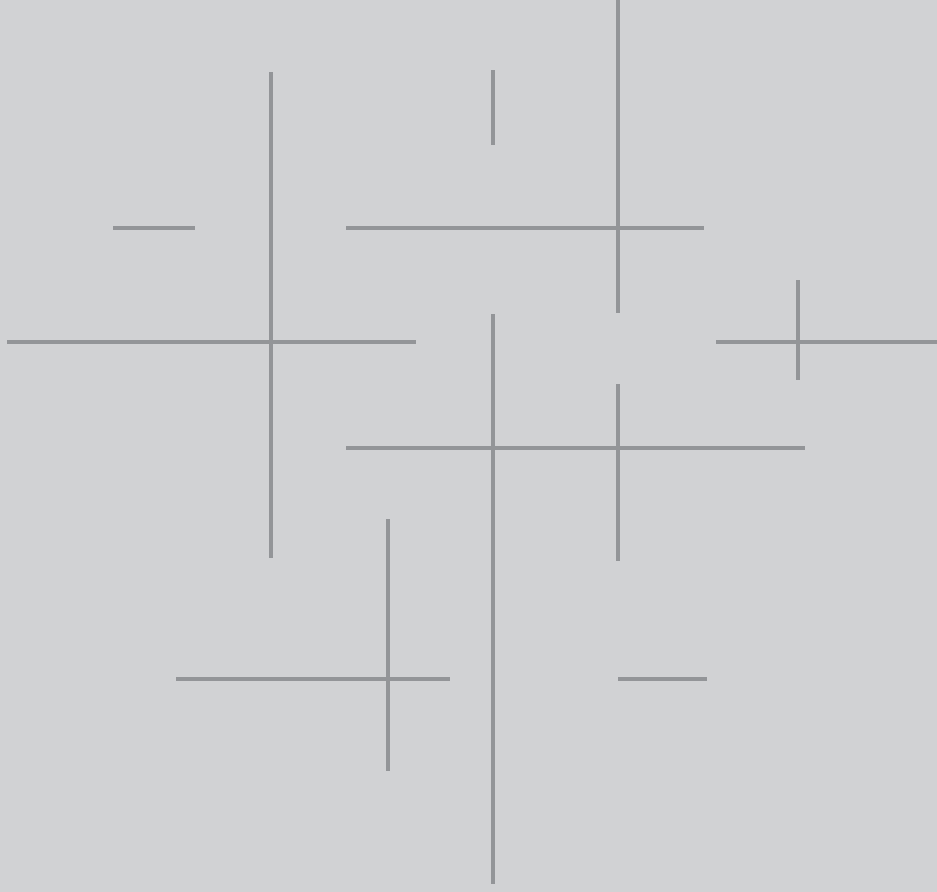

## **MK CEPHE 50**

MK FACADE 50

**31-76**







**PROFİL KESİT DETAYLARI**

PROFILE DETAILS DRAWINGS

# MK CEPHE 50

## MK FACADE 50

### PROFİL KESİT DETAYLARI

PROFİL KODU	1079
Tanım:	140 ' lık Kasa
Ağırlık:	2.300 kg/m
Jy:	33.49 cm <sup>4</sup>
Jx:	245.66 cm <sup>4</sup>
Cephe Bağlantı:	 1000-116
Cephe Bağlantı:	 1000-117
Cephe Bağlantı Yatay Çıtası	 1000-118
'U' Bağlantı:	 1000-119
'U' Bağlantı:	 1020
Cephe Bağlantı:	 1000-263

Kesim Ölçüsü  
128.0mm

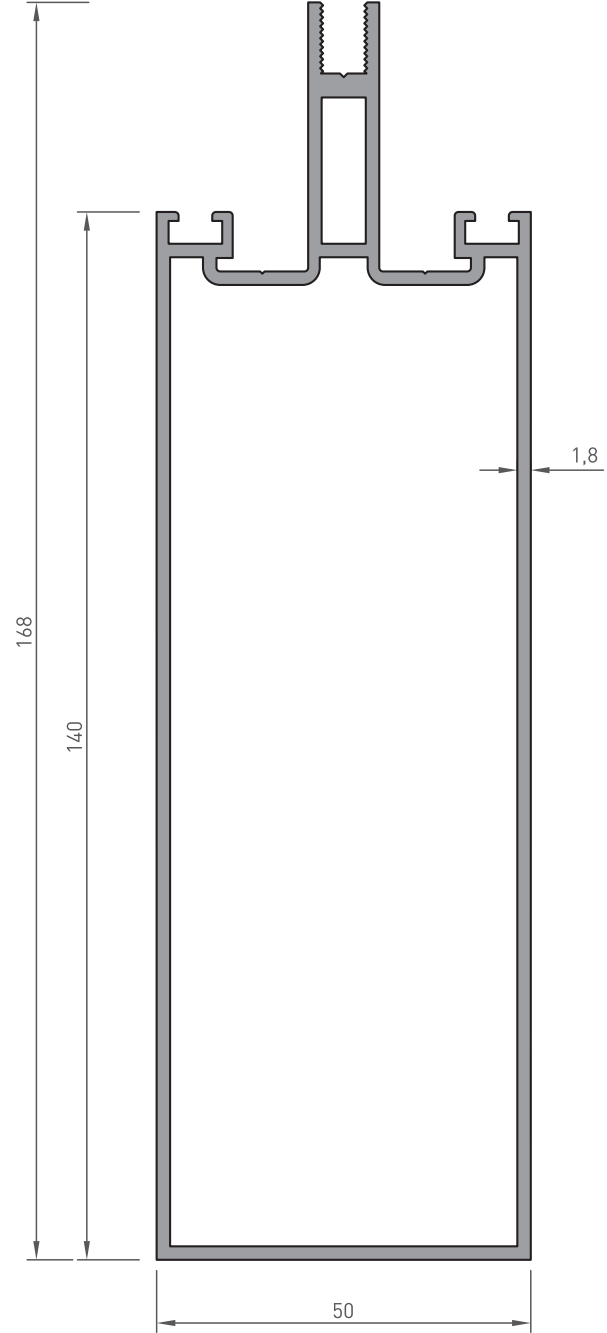



# MK CEPHE 50

## MK FACADE 50

### PROFİL KESİT DETAYLARI

PROFİL KODU	1078	
Tanım:	120 ' lik Kasa	
Ağırlık:	1.930 kg/m	
Jy:	26.94 cm <sup>4</sup>	
Jx:	159.69 cm <sup>4</sup>	
Cephe Bağlantı:	1000-116	Kesim Ölçüsü 108,4mm
Cephe Bağlantı:	1000-117	
Cephe Bağlantı Yatay Çıtası	1000-118	
'U' Bağlantı:	1000-119	
'U' Bağlantı:	1020	
Cephe Bağlantı:	1000-263	

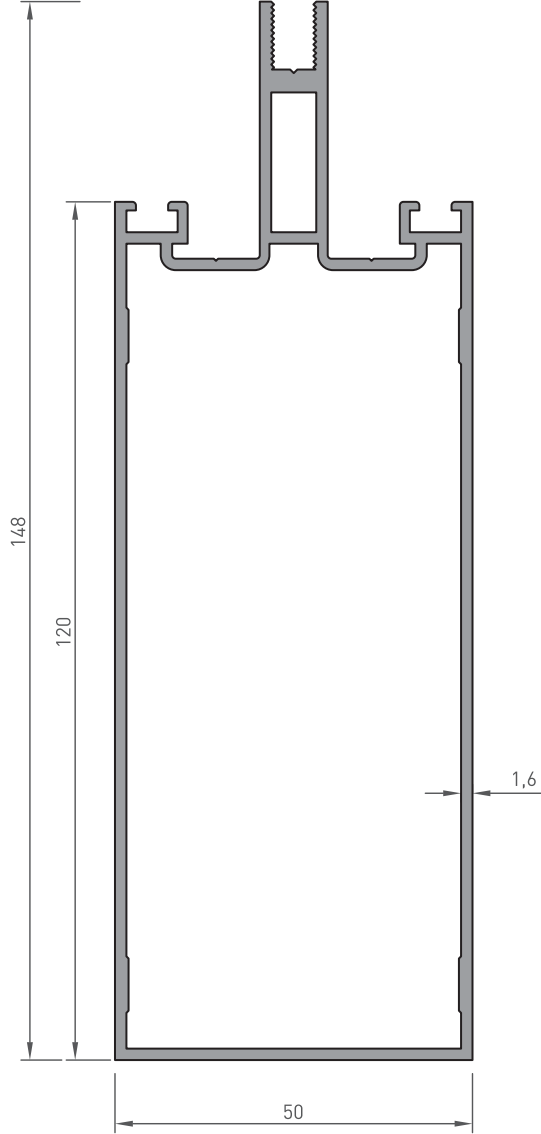





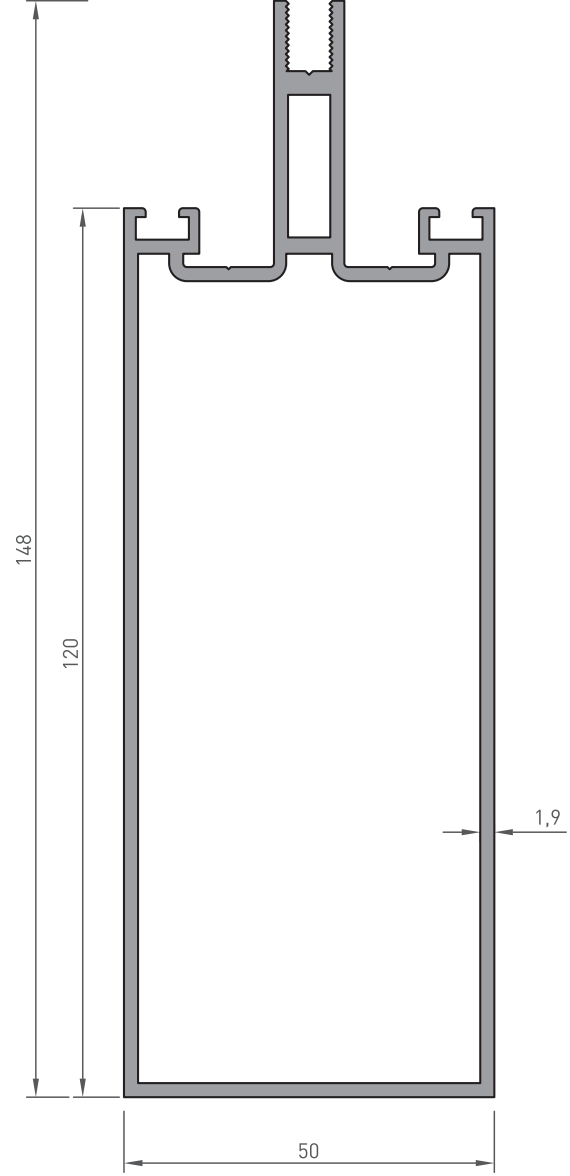

\*BELİRTİLEN AĞIRLIKLAR, TEORİK PRES ÇIKIŞ AĞIRLIKLARIDIR.  
\*BOYALI PROFİLLERDE AĞIRLIĞA %5 İLAVE EDİLMESİ GEREKLİDİR.

# MK CEPHE 50

## MK FACADE 50

### PROFİL KESİT DETAYLARI



PROFİL KODU	1077
Tanım:	120 ' lik Kasa
Ağırlık:	2.210 kg/m
Jy:	30.70 cm <sup>4</sup>
Jx:	179.93 cm <sup>4</sup>
Cephe Bağlantı:	 1000-116
Cephe Bağlantı:	 1000-117
Cephe Bağlantı Yatay Çıtası	 1000-118
'U' Bağlantı:	 1000-119
'U' Bağlantı:	 1020
Cephe Bağlantı:	 1000-263





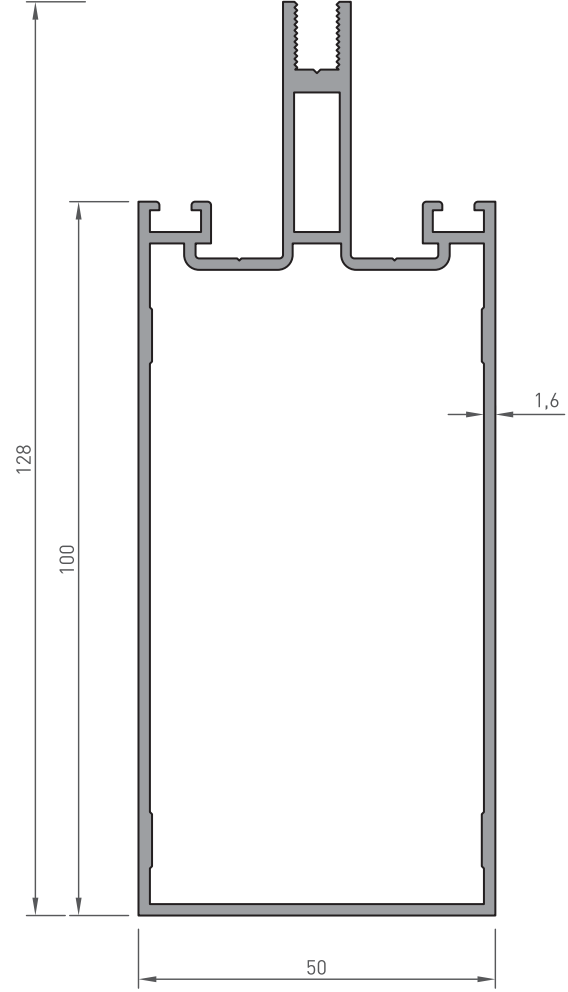

Kesim Ölçüsü  
**107.8mm**

# MK CEPHE 50

## MK FACADE 50

### PROFİL KESİT DETAYLARI



PROFİL KODU	1018
Tanım:	100 ' lük Kasa
Ağırlık:	1.750 kg/m
Jy:	23.19 cm <sup>4</sup>
Jx:	106.00 cm <sup>4</sup>
Cephe Bağlantı:	 1000-116
Cephe Bağlantı:	 1000-117
Cephe Bağlantı Yatay Çıtası	 1000-118
'U' Bağlantı:	 1000-119
'U' Bağlantı:	 1020
Cephe Bağlantı:	 1000-263

Kesim Ölçüsü  
88.4mm

\*BELİRTİLEN AĞIRLIKLAR, TEORİK PRES ÇIKIŞ AĞIRLIKLARIDIR.  
\*BOYALI PROFİLLERDE AĞIRLIĞA %5 İLAVE EDİLMESİ GEREKLİDİR.

# MK CEPHE 50

## MK FACADE 50

### PROFİL KESİT DETAYLARI

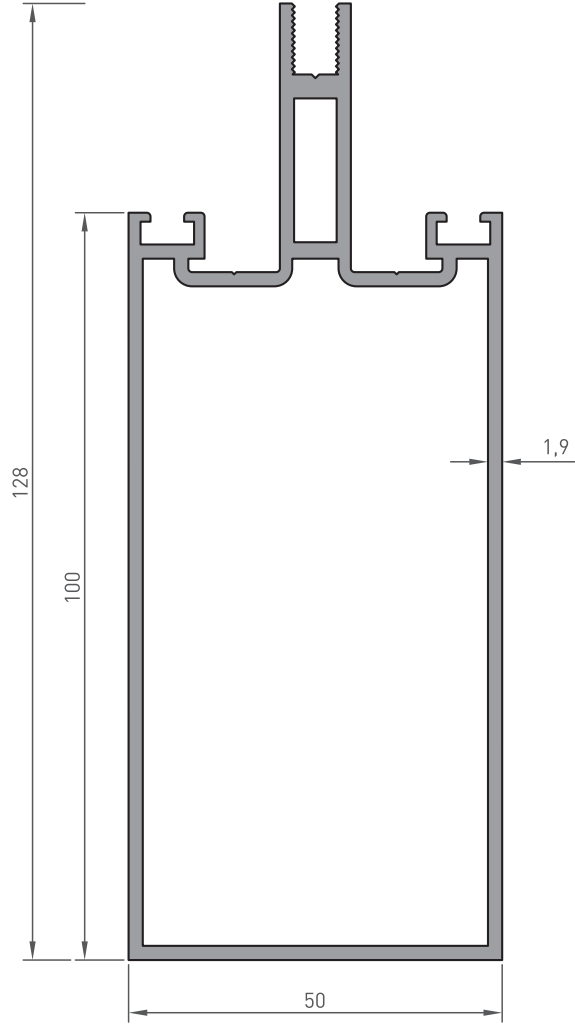





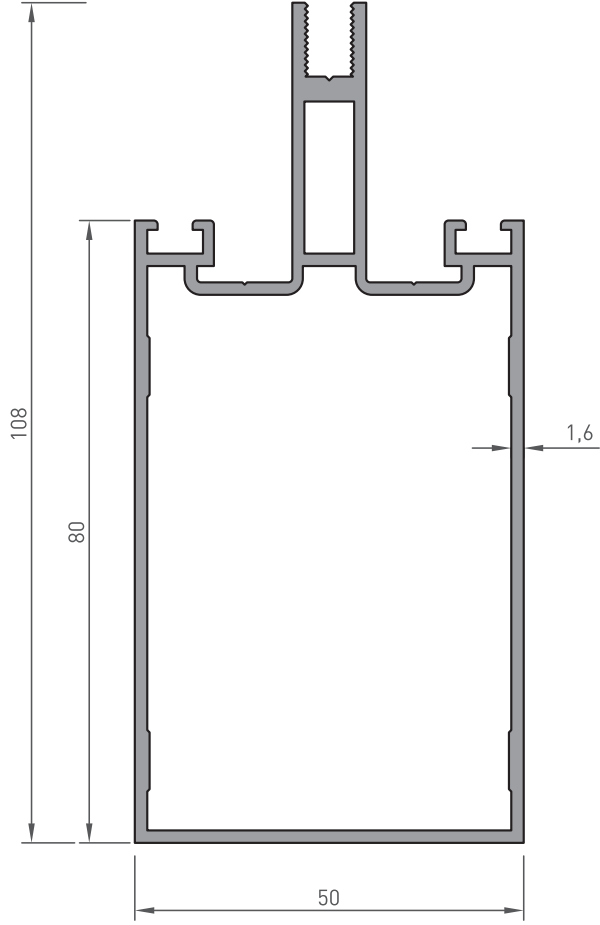

PROFİL KODU	1062	
Tanım:	100 ' lük Kasa	
Ağırlık:	2.005 kg/m	
Jy:	26.30 cm <sup>4</sup>	
Jx:	119.36 cm <sup>4</sup>	
Cephe Bağlantı:	1000-116	Kesim Ölçüsü 87,8mm
Cephe Bağlantı:	1000-117	
Cephe Bağlantı Yatay Çıtası	1000-118	
'U' Bağlantı:	1000-119	
'U' Bağlantı:	1020	
Cephe Bağlantı:	1000-263	

# MK CEPHE 50

## MK FACADE 50

### PROFİL KESİT DETAYLARI



PROFİL KODU	1059	
Tanım:	80 ' lik Kasa	
Ağırlık:	1.580 kg/m	
Jy:	19.44 cm <sup>4</sup>	
Jx:	65.54 cm <sup>4</sup>	
Cephe Bağlantı:	 1000-116	Kesim Ölçüsü 68.4mm
Cephe Bağlantı:	 1000-117	
Cephe Bağlantı Yatay Çıtası	 1000-118	
'U' Bağlantı:	 1000-119	
'U' Bağlantı:	 1020	
Cephe Bağlantı:	 1000-263	





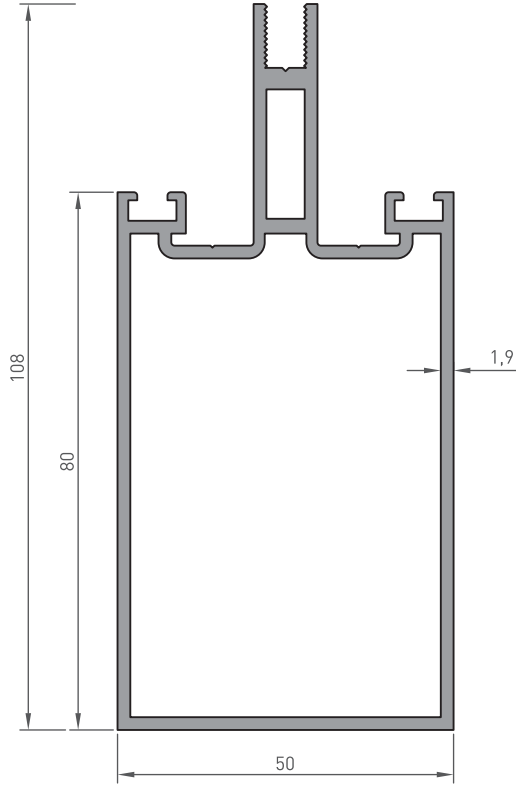

\*BELİRTİLEN AĞIRLIKLAR, TEORİK PRES ÇIKIŞ AĞIRLIKLARIDIR.  
\*BOYALI PROFİLLERDE AĞIRLIĞA %5 İLAVE EDİLMESİ GEREKLİDİR.

# MK CEPHE 50





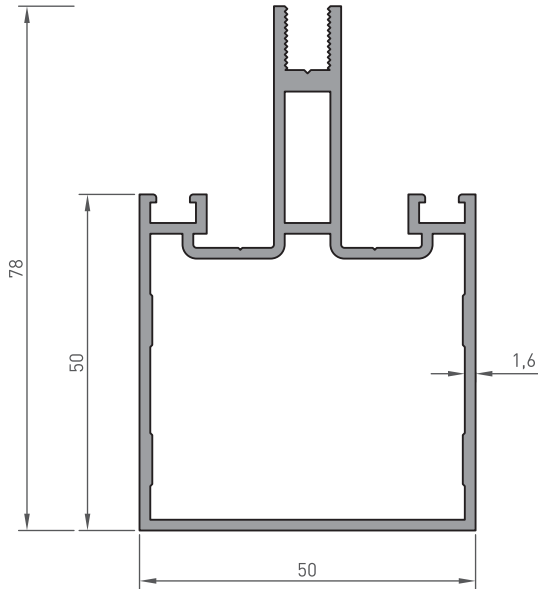

## MK FACADE 50

### PROFİL KESİT DETAYLARI



PROFİL KODU	1064	
Tanım:	80 ' lik Kasa	
Ağırlık:	1.800 kg/m	
Jy:	21.90 cm <sup>4</sup>	
Jx:	73.47 cm <sup>4</sup>	
Cephe Bağlantı:	 1000-116	Kesim Ölçüsü 67.8mm
Cephe Bağlantı:	 1000-117	
Cephe Bağlantı Yatay Çıtası	 1000-118	
'U' Bağlantı:	 1000-119	
'U' Bağlantı:	 1020	
Cephe Bağlantı:	 1000-263	







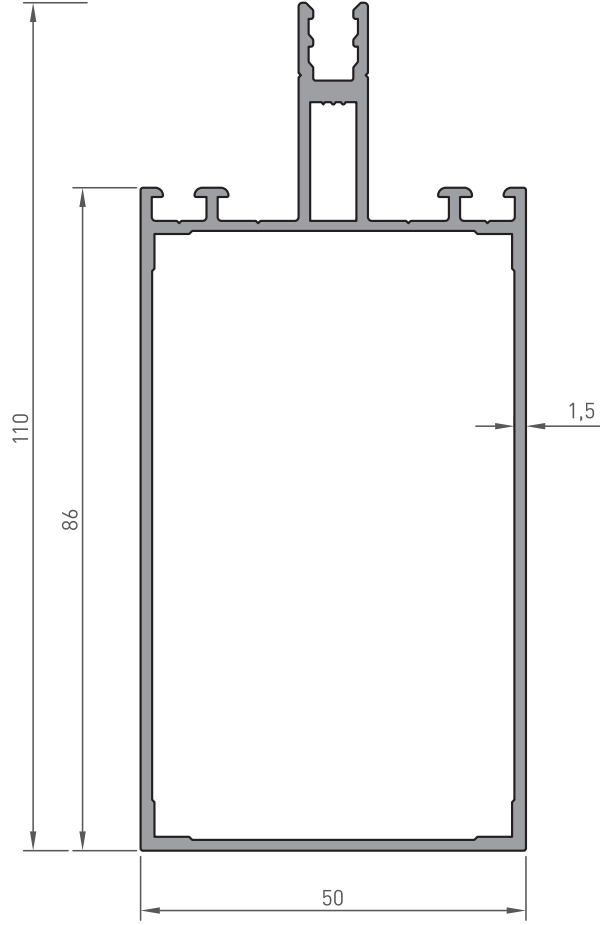

PROFİL KODU	1017	
Tanım:	50 ' lik Kasa	
Ağırlık:	1.320 kg/m	
Jy:	13.81 cm <sup>4</sup>	
Jx:	26.05 cm <sup>4</sup>	
Cephe Bağlantı:	 1000-116	Kesim Ölçüsü 38.4mm
Cephe Bağlantı:	 1000-117	
Cephe Bağlantı Yatay Çıtası	 1000-118	
'U' Bağlantı:	 1000-119	
'U' Bağlantı:	 1020	
Cephe Bağlantı:	 1000-263	

# MK CEPHE 50

## MK FACADE 50

### PROFİL KESİT DETAYLARI



PROFİL KODU	1057	
Tanım:	86 ' lık Kasa	
Ağırlık:	1.425 kg/m	
Jy:	18.90 cm <sup>4</sup>	
Jx:	65.47 cm <sup>4</sup>	
Cephe Bağlantı:	 1000-116	Kesim Ölçüsü 77.7mm
Cephe Bağlantı:	 1000-117	
Cephe Bağlantı Yatay Çıtası	 1000-118	
'U' Bağlantı:	 1000-119	
'U' Bağlantı:	 1020	
Cephe Bağlantı:	 1000-263	





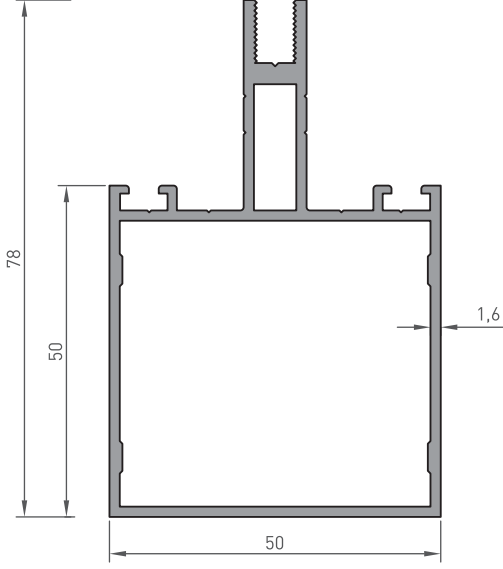

\*BELİRTİLEN AĞIRLIKLAR, TEORİK PRES ÇIKIŞ AĞIRLIKLARIDIR.  
\*BOYALI PROFİLLERDE AĞIRLIĞA %5 İLAVE EDİLMESİ GEREKLİDİR.

# MK CEPHE 50





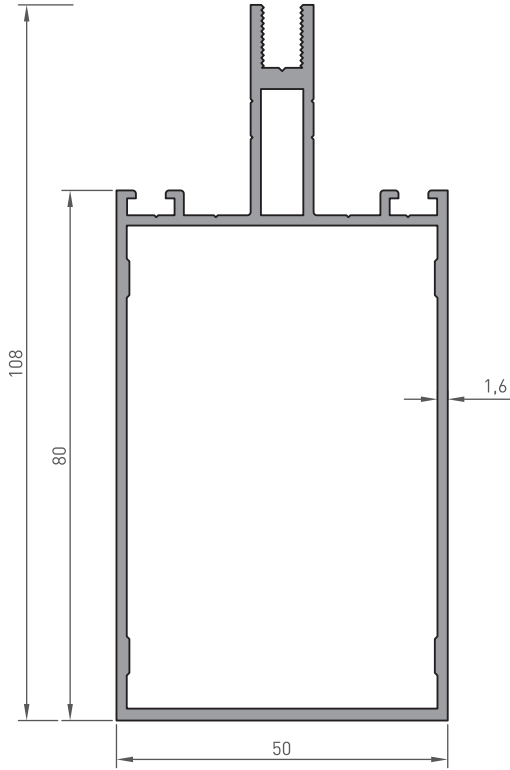

## MK FACADE 50

### PROFİL KESİT DETAYLARI



PROFİL KODU	1000 - 230	
Tanım:	50 ' lik Kasa	
Ağırlık:	1.235 kg/m	
Jy:	13.16 cm <sup>4</sup>	
Jx:	25.85 cm <sup>4</sup>	
Cephe Bağlantı:	 1000-116	Kesim Ölçüsü 42.7mm
Cephe Bağlantı:	 1000-117	
Cephe Bağlantı Yatay Çıtası	 1000-118	
'U' Bağlantı:	 1020	
'U' Bağlantı:	 1000-263	
Cephe Bağlantı:	 1000-119	









PROFİL KODU	1000 - 231	
Tanım:	80 ' lik Kasa	
Ağırlık:	1.525 kg/m	
Jy:	19.08 cm <sup>4</sup>	
Jx:	68.03 cm <sup>4</sup>	
Cephe Bağlantı:	 1000-116	Kesim Ölçüsü 72.4mm
Cephe Bağlantı:	 1000-117	
Cephe Bağlantı Yatay Çıtası	 1000-118	
'U' Bağlantı:	 1020	
'U' Bağlantı:	 1000-263	
Cephe Bağlantı:	 1000-119	



# MK CEPHE 50

## MK FACADE 50

### PROFİL KESİT DETAYLARI

PROFİL KODU	1000 - 232
Tanım:	100 ' lük Kasa
Ağırlık:	1.700 kg/m
Jy:	22.92 cm <sup>4</sup>
Jx:	109.21 cm <sup>4</sup>
Cephe Bağlantı:	 1000-116
Cephe Bağlantı:	 1000-117
Cephe Bağlantı Yatay Çıtası	 1000-118
'U' Bağlantı:	 1020
Cephe Bağlantı:	 1000-263
'U' Bağlantı:	 1000-119

Kesim Ölçüsü  
92.4mm

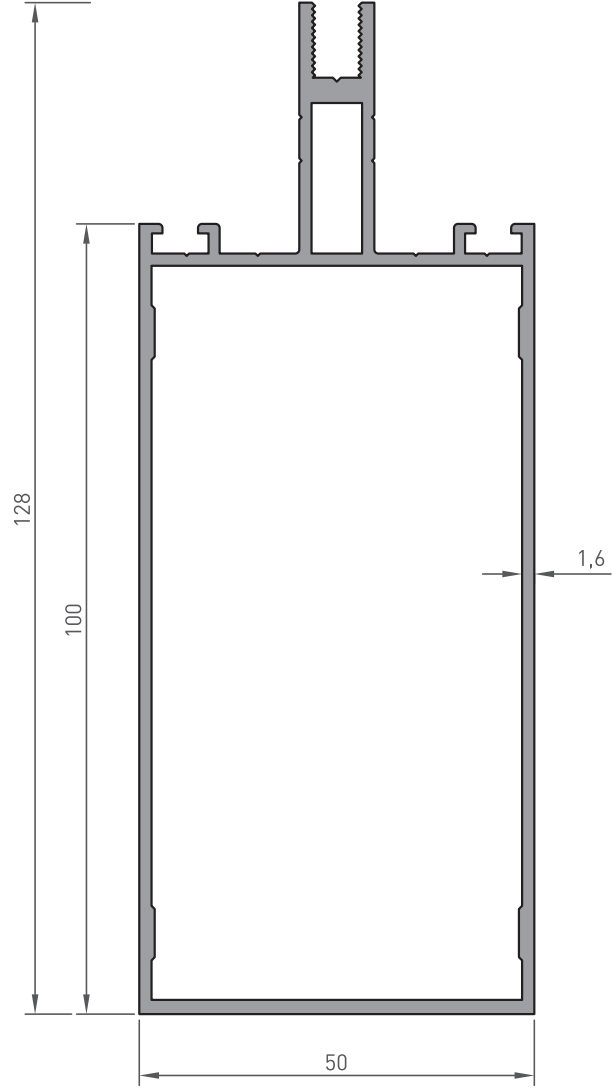







\*BELİRTİLEN AĞIRLIKLAR, TEORİK PRES ÇIKIŞ AĞIRLIKLARIDIR.  
\*BOYALI PROFİLLERDE AĞIRLIĞA %5 İLAVE EDİLMESİ GEREKLİDİR.

# MK CEPHE 50

## MK FACADE 50

### PROFİL KESİT DETAYLARI

PROFİL KODU	1000 - 199
Tanım:	100 ' lük Kasa
Ağırlık:	1.620 kg/m
Jy:	95,23 cm <sup>4</sup>
Jx:	22,36 cm <sup>4</sup>
Cephe Bağlantı:	 1000-116
Cephe Bağlantı:	 1000-117
Cephe Bağlantı Yatay Çıtası	 1000-118
'U' Bağlantı:	 1020
Cephe Bağlantı:	 1000-263
'U' Bağlantı:	 1000-119

Kesim Ölçüsü  
91.7mm

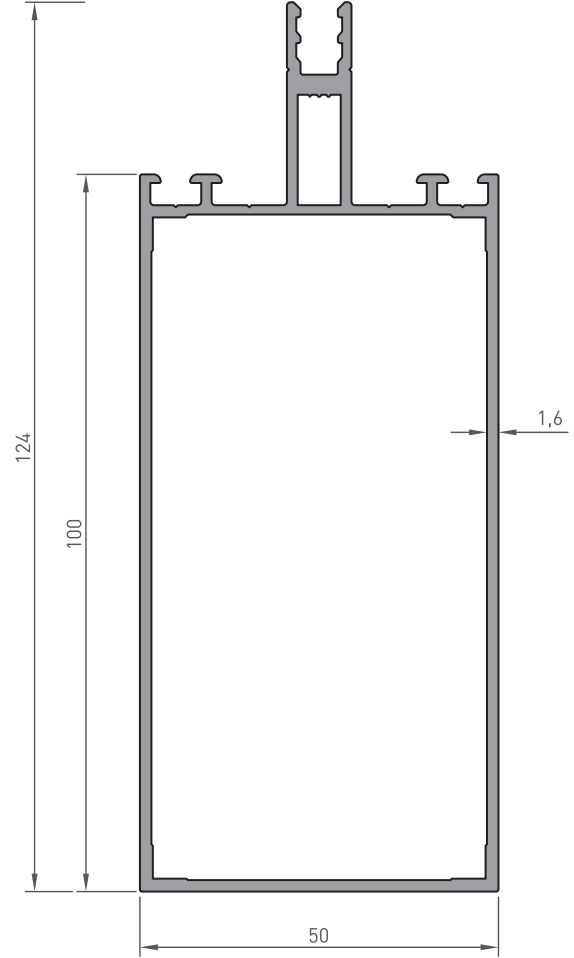





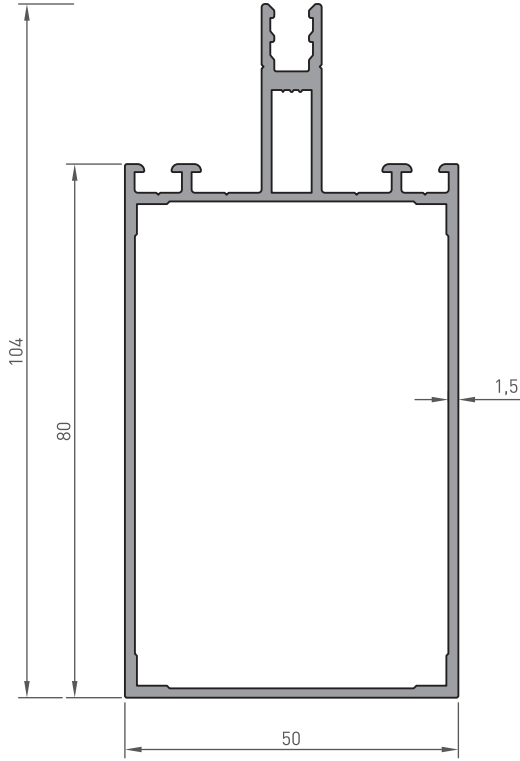

# MK CEPHE 50





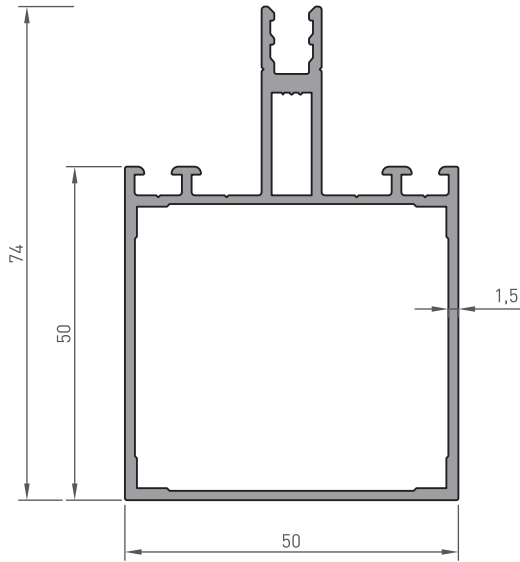

## MK FACADE 50

### PROFİL KESİT DETAYLARI



PROFİL KODU	1000 - 200	
Tanım:	80 ' lik Kasa	
Ağırlık:	1.390 kg/m	
Jy:	55,97 cm <sup>4</sup>	
Jx:	17,83 cm <sup>4</sup>	
Cephe Bağlantı:	 1000-116	Kesim Ölçüsü 71.7mm
Cephe Bağlantı:	 1000-117	
Cephe Bağlantı Yatay Çıtası	 1000-118	
'U' Bağlantı:	 1020	
Cephe Bağlantı:	 1000-263	
'U' Bağlantı:	 1000-119	



PROFİL KODU	1000 - 201	
Tanım:	50 ' lik Kasa	
Ağırlık:	1.145 kg/m	
Jy:	21,30 cm <sup>4</sup>	
Jx:	12,54 cm <sup>4</sup>	
Cephe Bağlantı:	 1000-116	Kesim Ölçüsü 41.7mm
Cephe Bağlantı:	 1000-117	
Cephe Bağlantı Yatay Çıtası	 1000-118	
'U' Bağlantı:	 1020	
Cephe Bağlantı:	 1000-263	
'U' Bağlantı:	 1000-119	

\*BELİRTİLEN AĞIRLIKLAR, TEORİK PRES ÇIKIŞ AĞIRLIKLARIDIR.  
\*BOYALI PROFİLLERDE AĞIRLIĞA %5 İLAVE EDİLMESİ GEREKLİDİR.

# MK CEPHE 50

## MK FACADE 50

### PROFİL KESİT DETAYLARI

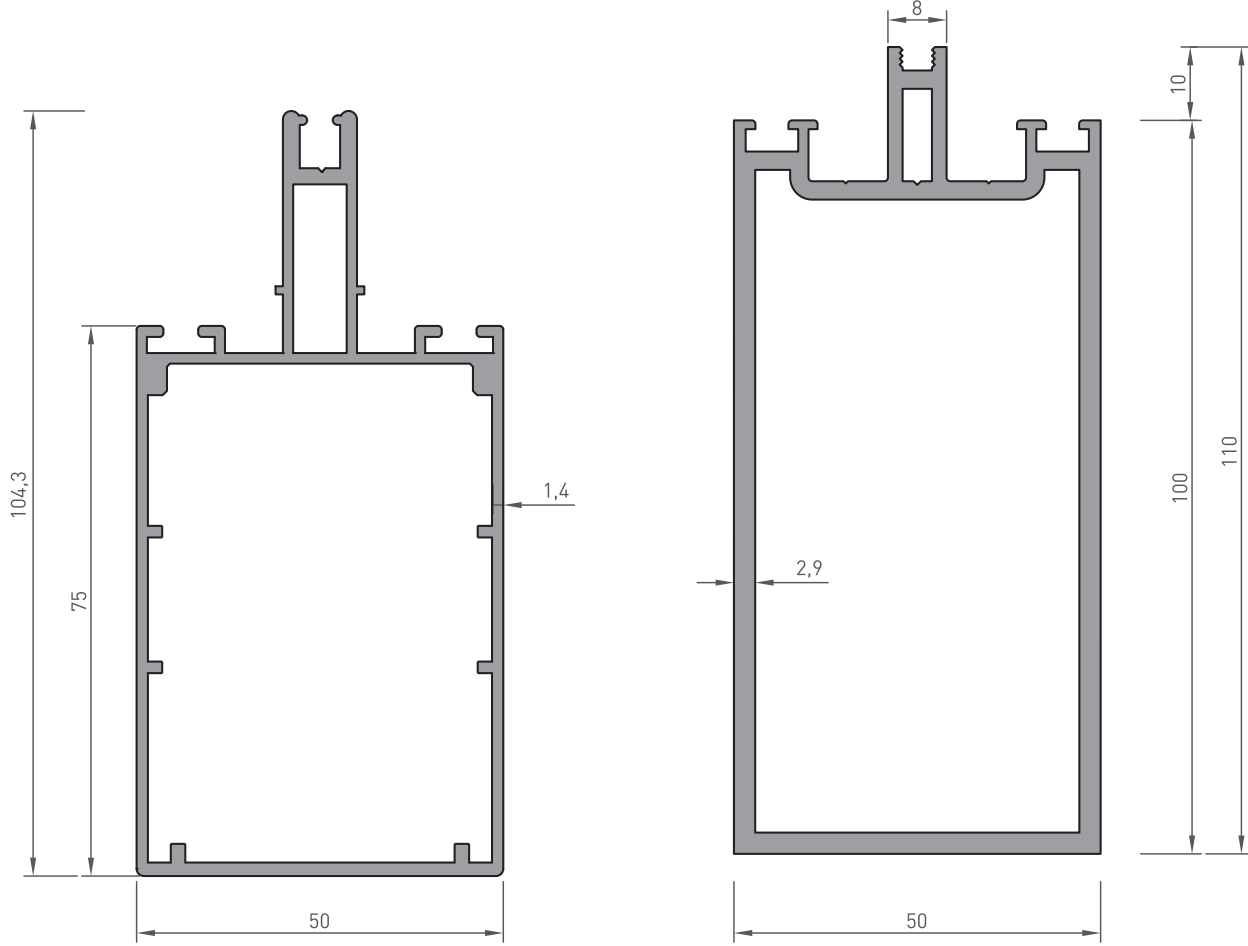

PROFİL KODU	1033
Tanım:	75'lik Cephe Profili
Ağırlık:	1.500 kg/m
Jy:	18.05 cm <sup>4</sup>
Jx:	61.13 cm <sup>4</sup>





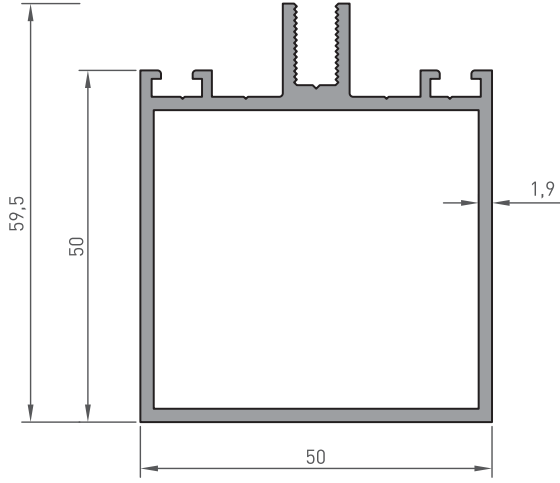

PROFİL KODU	1000-372
Tanım:	100'lük Cephe
Ağırlık:	2.560 kg/m
Jy:	12.34 cm <sup>4</sup>
Jx:	366.10 cm <sup>4</sup>

# MK CEPHE 50





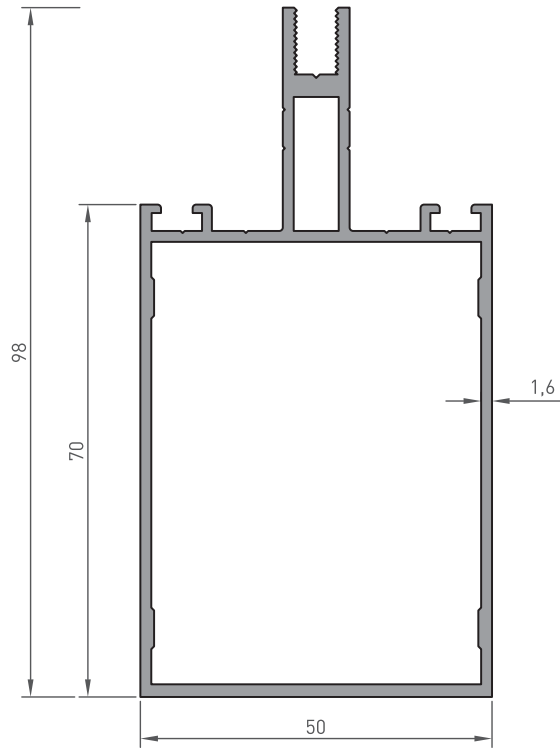

## MK FACADE 50

### PROFİL KESİT DETAYLARI



PROFİL KODU	1092	
Tanım:	50 ' lik Cephe Profili	
Ağırlık:	1.180 kg/m	
Jy:	14.57 cm <sup>4</sup>	
Jx:	17.15 cm <sup>4</sup>	
Cephe Bağlantı:	 1000-116	Kesim Ölçüsü 42.0mm
Cephe Bağlantı:	 1000-117	
Cephe Bağlantı Yatay Çıtası	 1000-118	
'U' Bağlantı:	 1000-119	
'U' Bağlantı:	 1020	
Cephe Bağlantı:	 1000-263	



PROFİL KODU	1090	
Tanım:	70 ' lik Cephe Profili	
Ağırlık:	1.430 kg/m	
Jy:	16.78 cm <sup>4</sup>	
Jx:	50.98 cm <sup>4</sup>	
Cephe Bağlantı:	 1000-116	Kesim Ölçüsü 62.4mm
Cephe Bağlantı:	 1000-117	
Cephe Bağlantı Yatay Çıtası	 1000-118	
'U' Bağlantı:	 1000-119	
'U' Bağlantı:	 1020	
Cephe Bağlantı:	 1000-263	





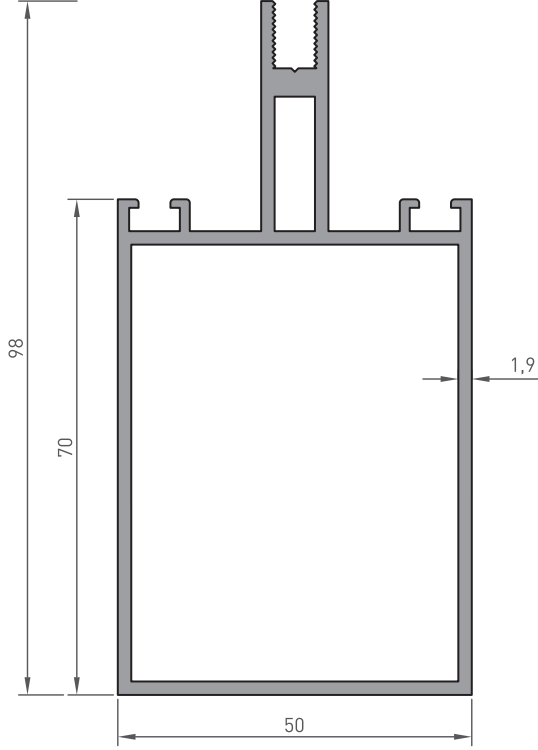

\*BELİRTİLEN AĞIRLIKLAR, TEORİK PRES ÇIKIŞ AĞIRLIKLARIDIR.  
\*BOYALI PROFİLLERDE AĞIRLIĞA %5 İLAVE EDİLMESİ GEREKLİDİR.

# MK CEPHE 50





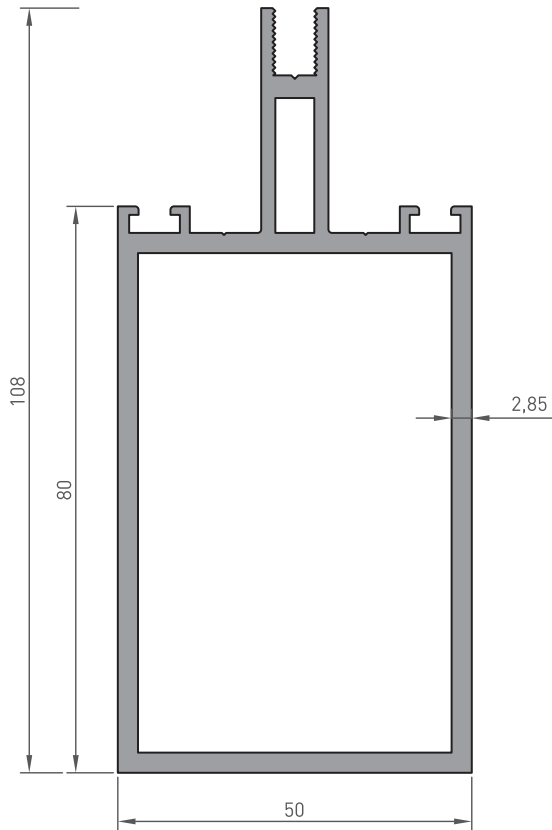

## MK FACADE 50

### PROFİL KESİT DETAYLARI



PROFİL KODU	1091	
Tanım:	70 ' lik Cephe Profili	
Ağırlık:	1.625 kg/m	
Jy:	19.11 cm <sup>4</sup>	
Jx:	55.85 cm <sup>4</sup>	
Cephe Bağlantı:	 1000-116	Kesim Ölçüsü 61.2mm
Cephe Bağlantı:	 1000-117	
Cephe Bağlantı Yatay Çıtası	 1000-118	
'U' Bağlantı:	 1000-119	
'U' Bağlantı:	 1020	
Cephe Bağlantı:	 1000-263	



PROFİL KODU	1093	
Tanım:	80 ' lik Cephe Profili	
Ağırlık:	2.315 kg/m	
Jy:	29.70 cm <sup>4</sup>	
Jx:	93.21 cm <sup>4</sup>	
Cephe Bağlantı:	 1000-116	Kesim Ölçüsü 70.1mm
Cephe Bağlantı:	 1000-117	
Cephe Bağlantı Yatay Çıtası	 1000-118	
'U' Bağlantı:	 1000-119	
'U' Bağlantı:	 1020	
Cephe Bağlantı:	 1000-263	

# MK CEPHE 50

## MK FACADE 50

### PROFİL KESİT DETAYLARI

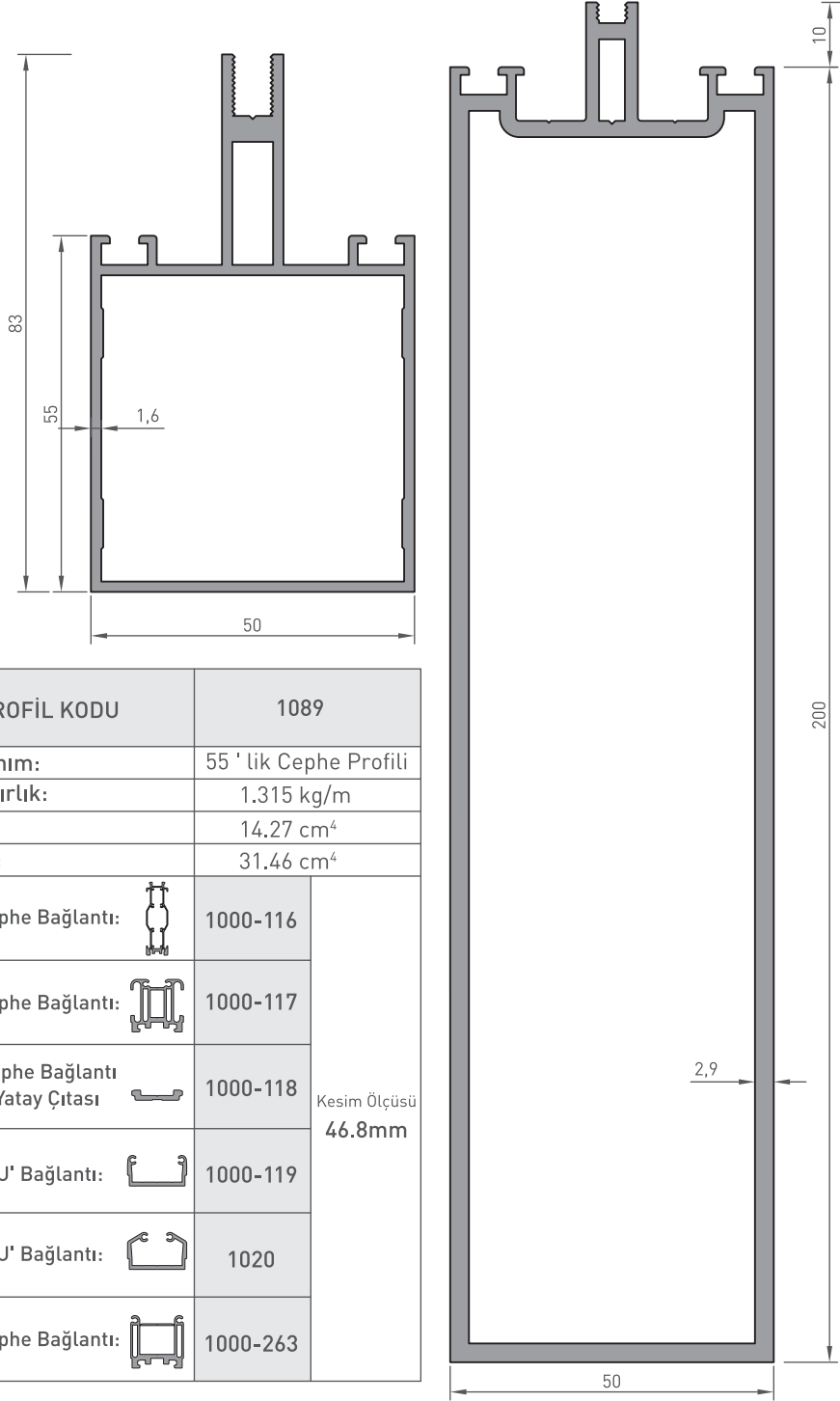



\*BELİRTİLEN AĞIRLIKLAR, TEORİK PRES ÇIKIŞ AĞIRLIKLARIDIR.  
\*BOYALI PROFİLLERDE AĞIRLIĞA %5 İLAVE EDİLMESİ GEREKLİDİR.

# MK CEPHE 50

## MK FACADE 50

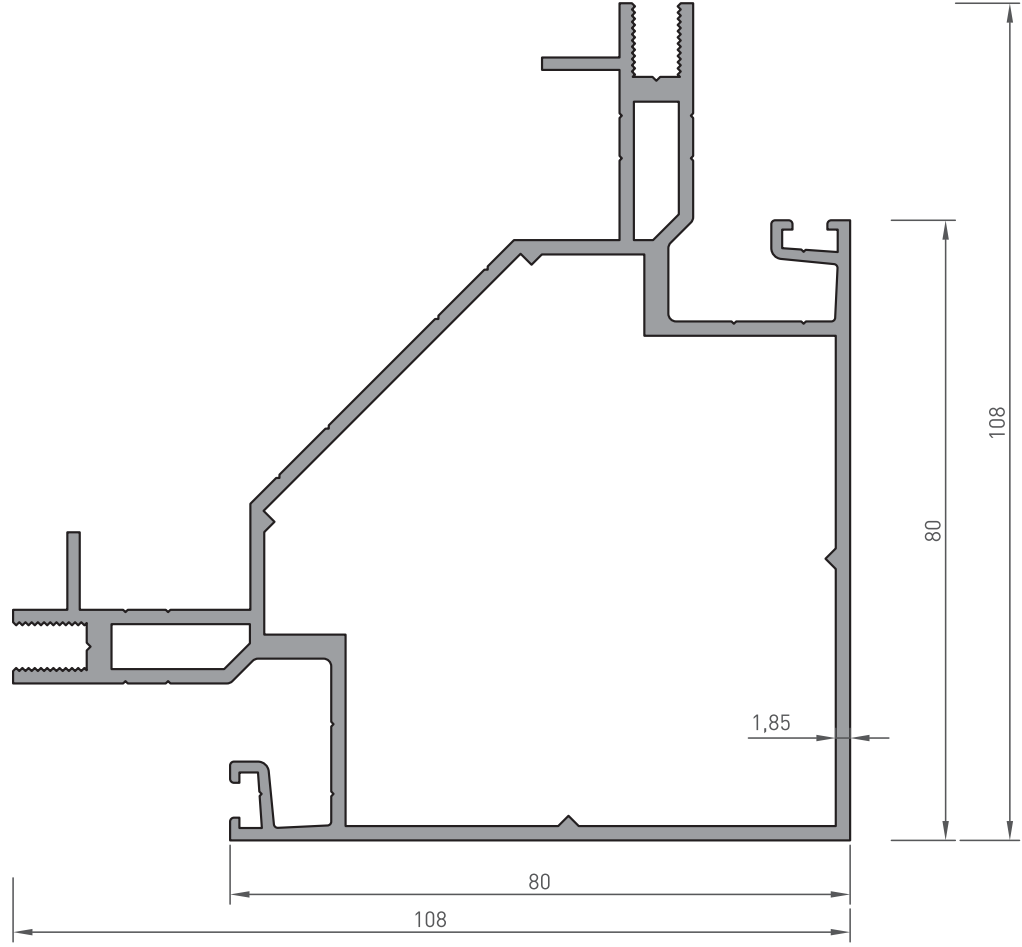
### PROFİL KESİT DETAYLARI



PROFİL KODU	1080	
Tanım:	90° Dönüş Cephe Profili	
Ağırlık:	2.540 kg/m	
Jy:	63.46 cm <sup>4</sup>	
Jx:	135.77 cm <sup>4</sup>	
Cephe Bağlantı:		1000-116 Kesim Ölçüsü 57.5mm



# MK CEPHE 50

## MK FACADE 50

### PROFİL KESİT DETAYLARI

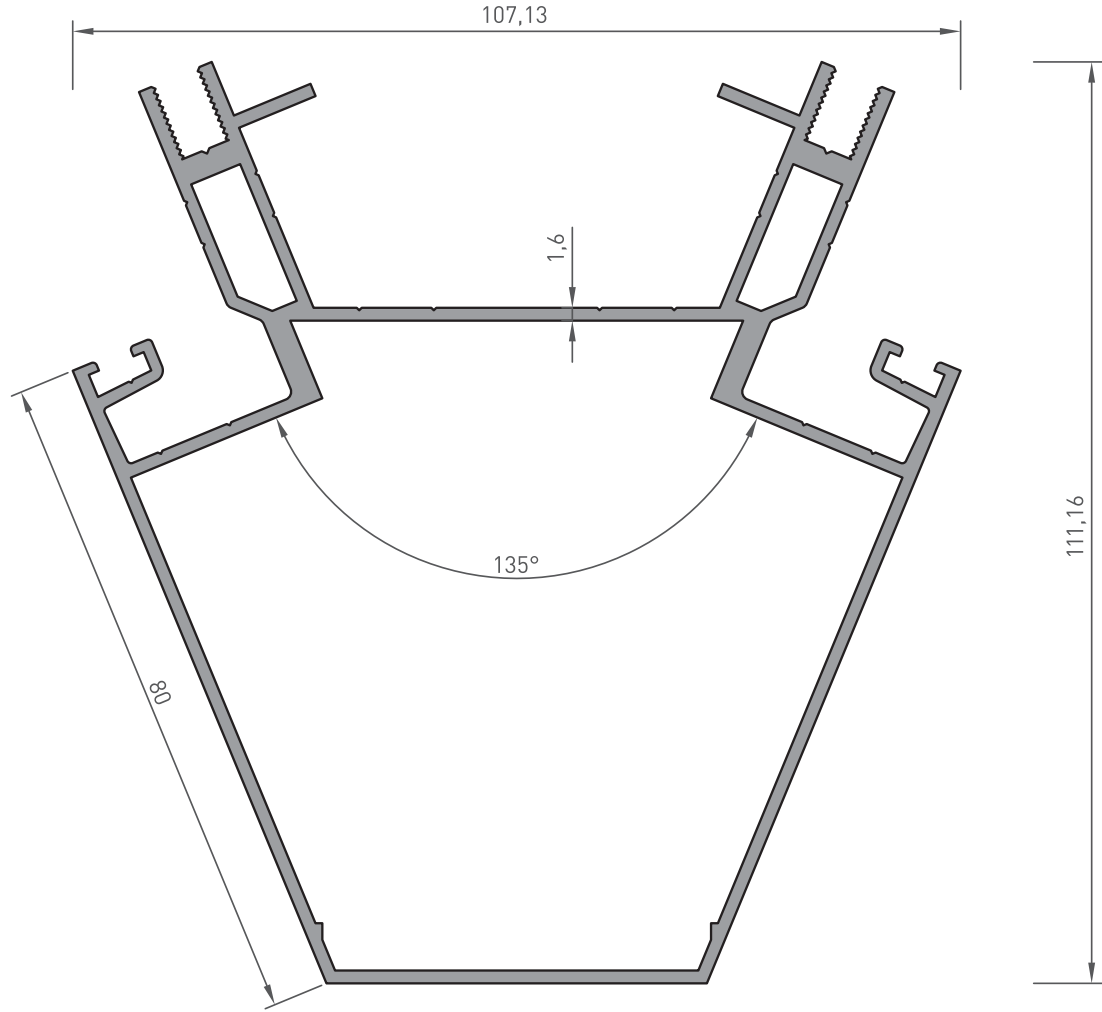

PROFİL KODU	1081
Tanım:	135° Açılı Cephe Profili
Ağırlık:	2.355 kg/m
Jy:	92.78 cm <sup>4</sup>
Jx:	99.38 cm <sup>4</sup>
Cephe Bağlantı:	 1000-116 Kesim Ölçüsü 75.5mm

\*BELİRTİLEN AĞIRLIKLAR, TEORİK PRES ÇIKIŞ AĞIRLIKLARIDIR.  
\*BOYALI PROFİLLERDE AĞIRLIĞA %5 İLAVE EDİLMESİ GEREKLİDİR.

# MK CEPHE 50

## MK FACADE 50

### PROFİL KESİT DETAYLARI

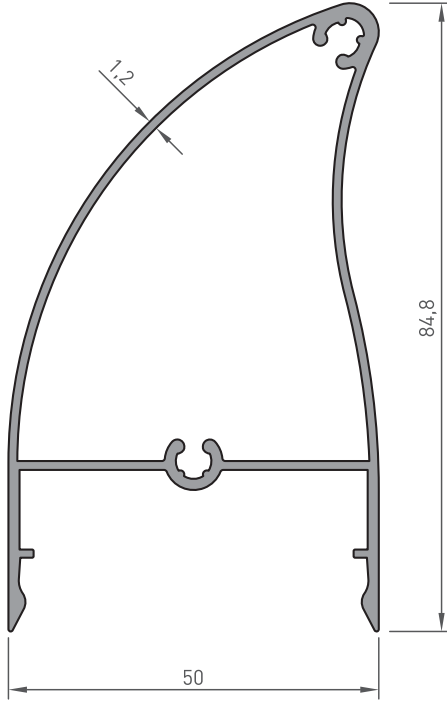

PROFİL KODU	1030
Tanım:	85' lik Badem Kapak
Ağırlık:	0.945 kg/m
Jy:	10.23 cm <sup>4</sup>
Jx:	24.77 cm <sup>4</sup>

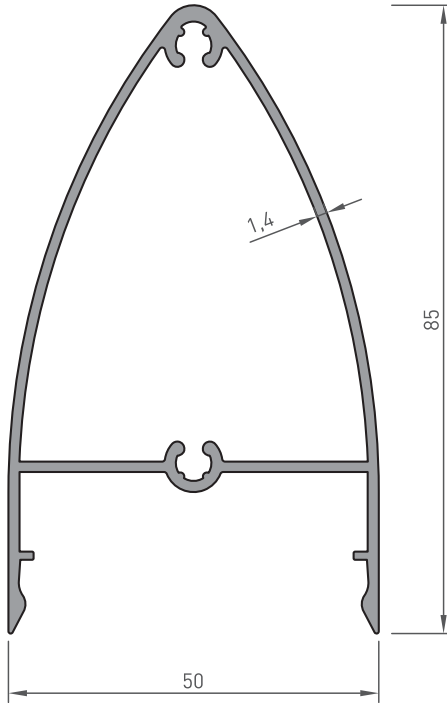

PROFİL KODU	1094
Tanım:	85' lik Badem Kapak
Ağırlık:	0.990 kg/m
Jy:	11.60 cm <sup>4</sup>
Jx:	22.79 cm <sup>4</sup>

# MK CEPHE 50

## MK FACADE 50

### PROFİL KESİT DETAYLARI

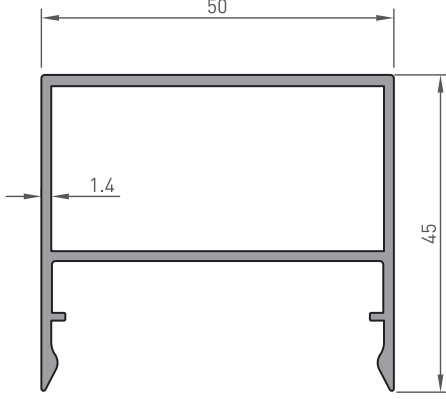

PROFİL KODU	1000 - 262
Tanım:	45' lik Kapak
Ağırlık:	0.745 kg/m
Jy:	5.00 cm <sup>4</sup>
Jx:	10.45 cm <sup>4</sup>

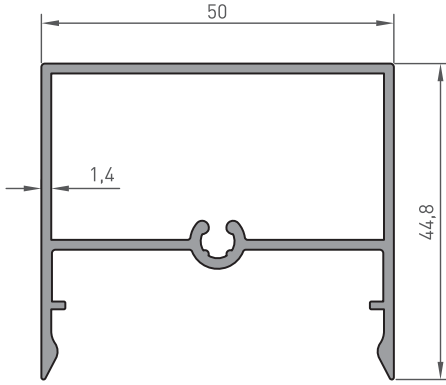

PROFİL KODU	1095
Tanım:	45' lik Kapak
Ağırlık:	0.760 kg/m
Jy:	5.08 cm <sup>4</sup>
Jx:	10.34 cm <sup>4</sup>

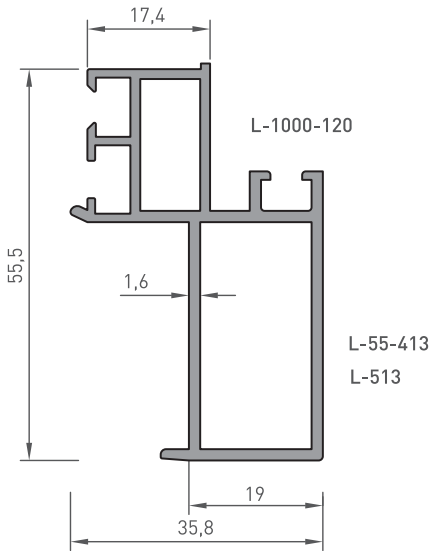

PROFİL KODU	1019	
Tanım:	Kaset Profili	
Ağırlık:	0.830 kg/m	
Jy:	2.32 cm <sup>4</sup>	
Jx:	9.83 cm <sup>4</sup>	
Köşe Takozu :	55-413	Kesim Ölçüsü 31.7mm
Köşe Bağlantı :	513	
Köşe Takozu :	1000-120	Kesim Ölçüsü 18.2mm
Çerçeve Bağlantı :	1029	Kesim Ölçüsü 50.0mm





\*BELİRTİLEN AĞIRLIKLAR, TEORİK PRES ÇIKIŞ AĞIRLIKLARIDIR.  
\*BOYALI PROFİLLERDE AĞIRLIĞA %5 İLAVE EDİLMESİ GEREKLİDİR.

# MK CEPHE 50

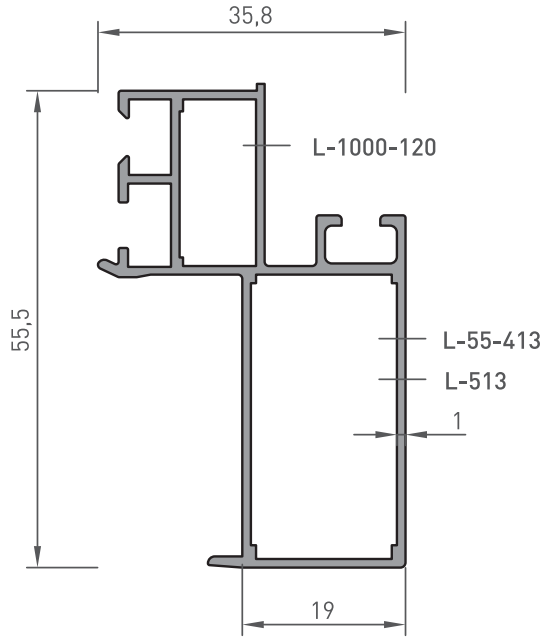
## MK FACADE 50

### PROFİL KESİT DETAYLARI



PROFİL KODU	1000 - 266	
Tanım:	Kaset Profili	
Ağırlık:	0.620 kg/m	
Jy:	1,77 cm <sup>4</sup>	
Jx:	7,22 cm <sup>4</sup>	
Köşe Takozu :	 55-413	Kesim Ölçüsü 32.6mm
Köşe Bağlantı :	 513	
Köşe Takozu :	 1000-120	Kesim Ölçüsü 18.9mm
Çerçeve Bağlantı :	 1029	Kesim Ölçüsü 50.0mm

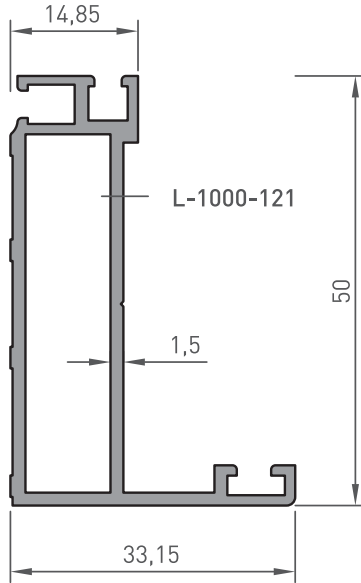

PROFİL KODU	1024	
Tanım:	Gizli Kanat Kasası	
Ağırlık:	0.625 kg/m	
Jy:	1.41 cm <sup>4</sup>	
Jx:	7.37 cm <sup>4</sup>	
Köşe Takozu :	 1000-121	Kesim Ölçüsü 41.2mm

# MK CEPHE 50

## MK FACADE 50

### PROFİL KESİT DETAYLARI

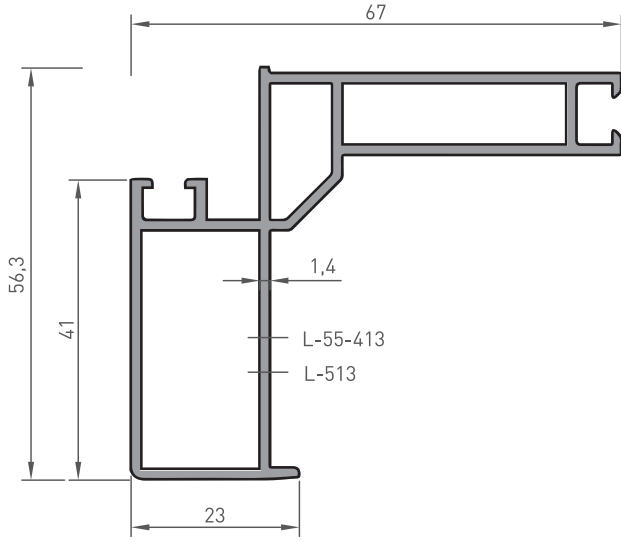

PROFİL KODU	1023	
Tanım:	Kaset Profili	
Ağırlık:	1.020 kg/m	
Jy:	4.78 cm <sup>4</sup>	
Jx:	21.22 cm <sup>4</sup>	
Köşe Takozu:	55-413	Kesim Ölçüsü 32.1mm
Köşe Bağlantı:	513	

\*BELİRTİLEN AĞIRLIKLAR, TEORİK PRES ÇIKIŞ AĞIRLIKLARIDIR.  
\*BOYALI PROFİLLERDE AĞIRLIĞA %5 İLAVE EDİLMESİ GEREKLİDİR.

# MK CEPHE 50

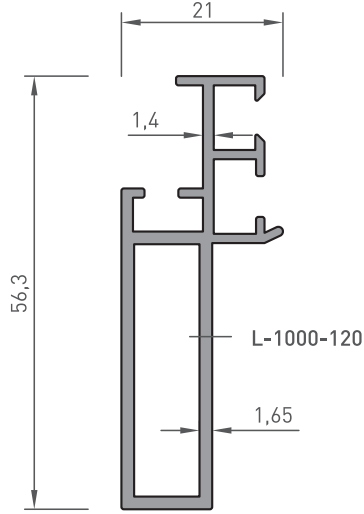

## MK FACADE 50

### PROFİL KESİT DETAYLARI

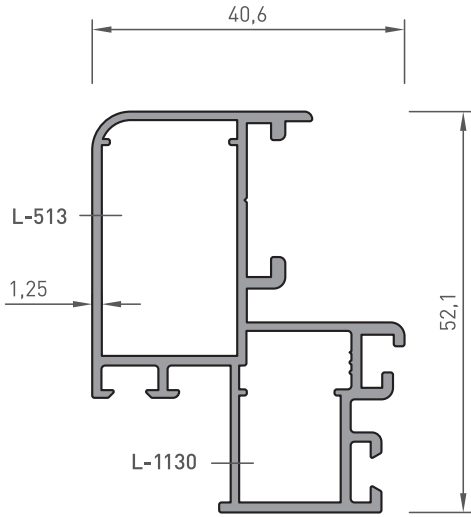

PROFİL KODU	1053
Tanım:	Kaset Profili
Ağırlık:	0.605 kg/m
Jy:	0.60 cm <sup>4</sup>
Jx:	6.49 cm <sup>4</sup>
Köşe Takozu:	 1000-120 Kesim Ölçüsü 32.3mm



PROFİL KODU	1056
Tanım:	Kaset Profili
Ağırlık:	0.790 kg/m
Jy:	3.02 cm <sup>4</sup>
Jx:	8.41 cm <sup>4</sup>
Köşe Takozu:	 513 Kesim Ölçüsü 26.9mm
Köşe Bağlantı:	 1130 Kesim Ölçüsü 13.4mm

# MK CEPHE 50



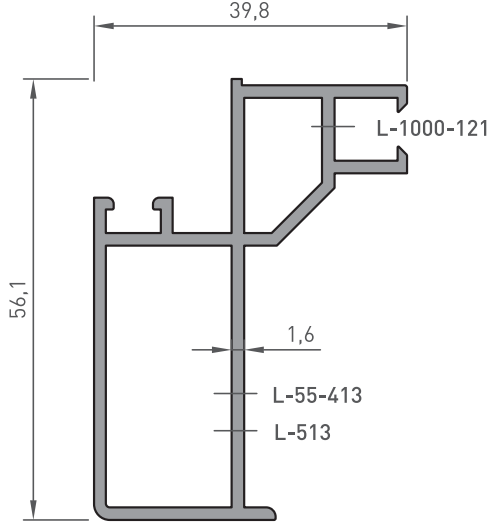

## MK FACADE 50

### PROFİL KESİT DETAYLARI

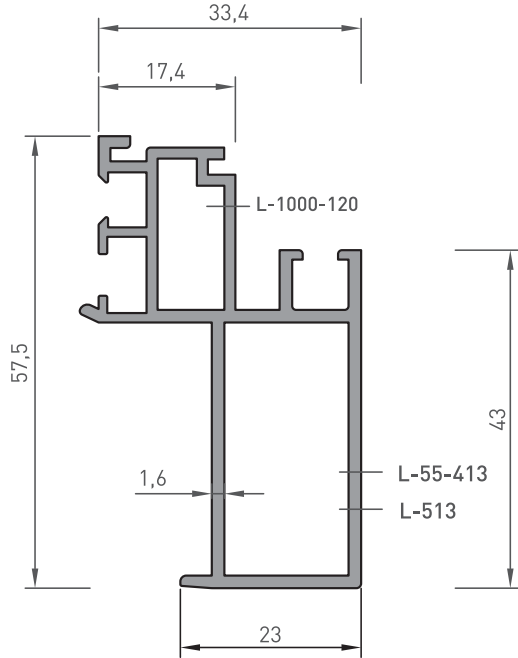

PROFİL KODU	1063
Tanım:	Kaset Profili
Ağırlık:	0.830 kg/m
Jy:	2.35 cm <sup>4</sup>
Jx:	11.26 cm <sup>4</sup>
Köşe Takozu:	 1000-121 Kesim Ölçüsü 10.4mm
Köşe Takozu:	 55-413 Kesim Ölçüsü 32.8mm
Köşe Bağlantı:	 513



PROFİL KODU	1082
Tanım:	Kaset Profili
Ağırlık:	0.875 kg/m
Jy:	2.47 cm <sup>4</sup>
Jx:	10.83 cm <sup>4</sup>
Köşe Takozu:	 1000-120 Kesim Ölçüsü 15.3mm
Köşe Takozu:	 55-413 Kesim Ölçüsü 31.7mm
Köşe Bağlantı:	 513
Çerçeve Bağlantı:	 1029 Kesim Ölçüsü 50.0mm



\*BELİRTİLEN AĞIRLIKLAR, TEORİK PRES ÇIKIŞ AĞIRLIKLARIDIR.  
\*BOYALI PROFİLLERDE AĞIRLIĞA %5 İLAVE EDİLMESİ GEREKLİDİR.

# MK CEPHE 50

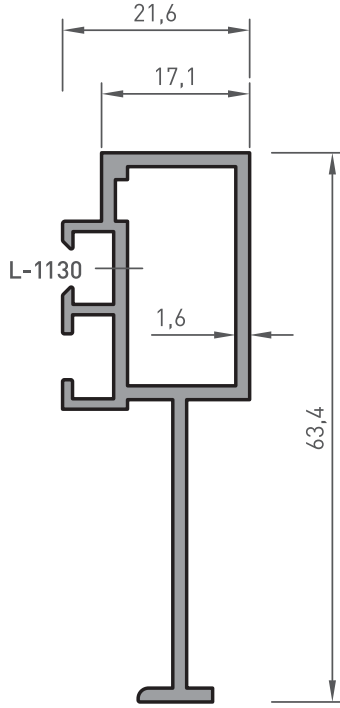

## MK FACADE 50

### PROFİL KESİT DETAYLARI

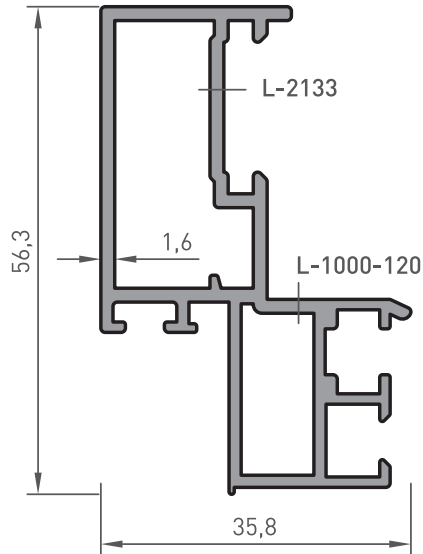

PROFİL KODU	1083	
Tanım:	Kompozit Çerçeve	
Ağırlık:	0.630 kg/m	
Jy:	0.90 cm <sup>4</sup>	
Jx:	7.96 cm <sup>4</sup>	
Köşe Bağlantı :		1130 Kesim Ölçüsü 24.8mm
Çerçeve Bağlantı :		1029 Kesim Ölçüsü 50.0mm



PROFİL KODU	1000-260	
Tanım:	Kaset Profili	
Ağırlık:	0.870 kg/m	
Jy:	1.97 cm <sup>4</sup>	
Jx:	14.24 cm <sup>4</sup>	
Köşe Takozu :		2133 Kesim Ölçüsü 30.4mm
Köşe Takozu :		1000-120 Kesim Ölçüsü 18.2mm



# MK CEPHE 50

## MK FACADE 50

### PROFİL KESİT DETAYLARI

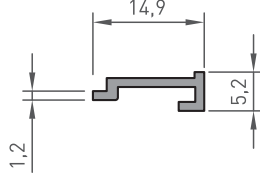

PROFİL KODU	1084
Tanım:	Kaset Bant Tiji
Ağırlık:	0.075 kg/m

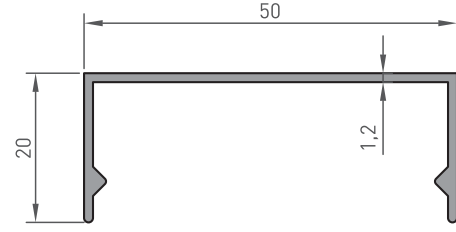

PROFİL KODU	1052
Tanım:	20' lik Kapak
Ağırlık:	0.315 kg/m

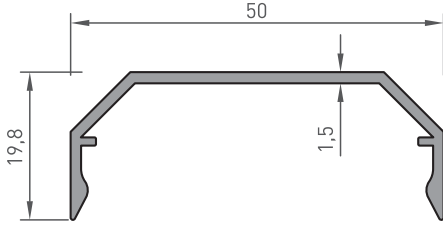

PROFİL KODU	1096
Tanım:	20' lik Kapak
Ağırlık:	0.330 kg/m

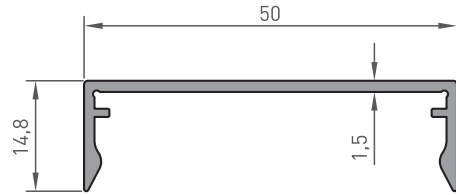

PROFİL KODU	1098
Tanım:	15' lik Kapak
Ağırlık:	0.325 kg/m

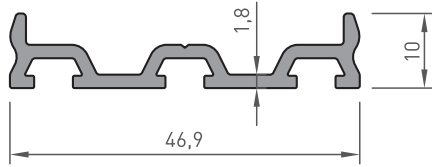

PROFİL KODU	1099
Tanım:	Kapak Altı
Ağırlık:	0.395 kg/m

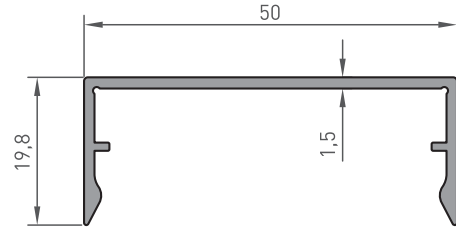

PROFİL KODU	1097
Tanım:	20'lik Kapak
Ağırlık:	0.360 kg/m

\*BELİRTİLEN AĞIRLIKLAR, TEORİK PRES ÇIKIŞ AĞIRLIKLARIDIR.  
\*BOYALI PROFİLLERDE AĞIRLIĞA %5 İLAVE EDİLMESİ GEREKLİDİR.

# MK CEPHE 50

## MK FACADE 50

### PROFİL KESİT DETAYLARI

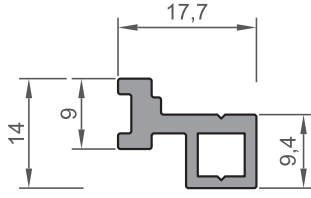

PROFİL KODU	1029
Tanım:	Çerçeve Bağlantı
Ağırlık:	0.250 kg/m
Kesim Ölçüsü:	50.0 mm

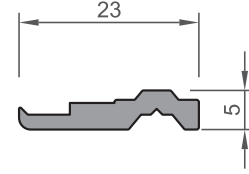

PROFİL KODU	1085
Tanım:	Cam Tutucu
Ağırlık:	0.185 kg/m
Kesim Ölçüsü:	50.0 mm

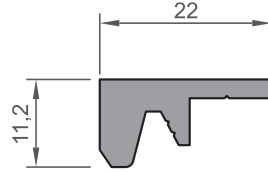

PROFİL KODU	1088
Tanım:	Geçme Alt Bağlantı
Ağırlık:	0.320 kg/m
Kesim Ölçüsü:	25.0 mm

# MK CEPHE 50

## MK FACADE 50

### PROFİL KESİT DETAYLARI

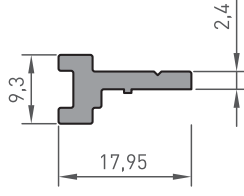

PROFİL KODU	1000-137
Tanım:	Kaset Bağlantı
Ağırlık:	0.185 kg/m

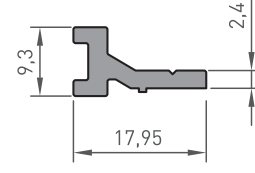

PROFİL KODU	1000-175
Tanım:	Çevre Bağlantı
Ağırlık:	0.180 kg/m

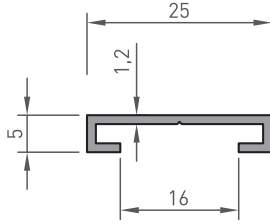

PROFİL KODU	516
Tanım:	Tij Çubuğu - Dış
Ağırlık:	0.130 kg/m

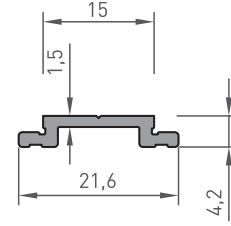

PROFİL KODU	517
Tanım:	Tij Çubuğu - İç
Ağırlık:	0.130 kg/m

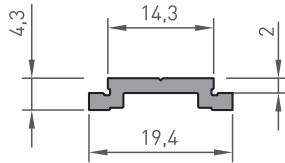

PROFİL KODU	1042
Tanım:	Tij Çubuğu
Ağırlık:	0.135 kg/m

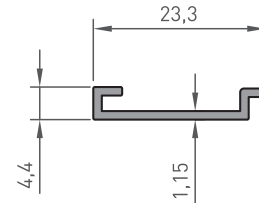

PROFİL KODU	1000-189
Tanım:	Kaset Bant Tiji
Ağırlık:	0.110 kg/m

\*BELİRTİLEN AĞIRLIKLAR, TEORİK PRES ÇIKIŞ AĞIRLIKLARIDIR.  
\*BOYALI PROFİLLERDE AĞIRLIĞA %5 İLAVE EDİLMESİ GEREKLİDİR.

# MK CEPHE 50

## MK FACADE 50

### PROFİL KESİT DETAYLARI

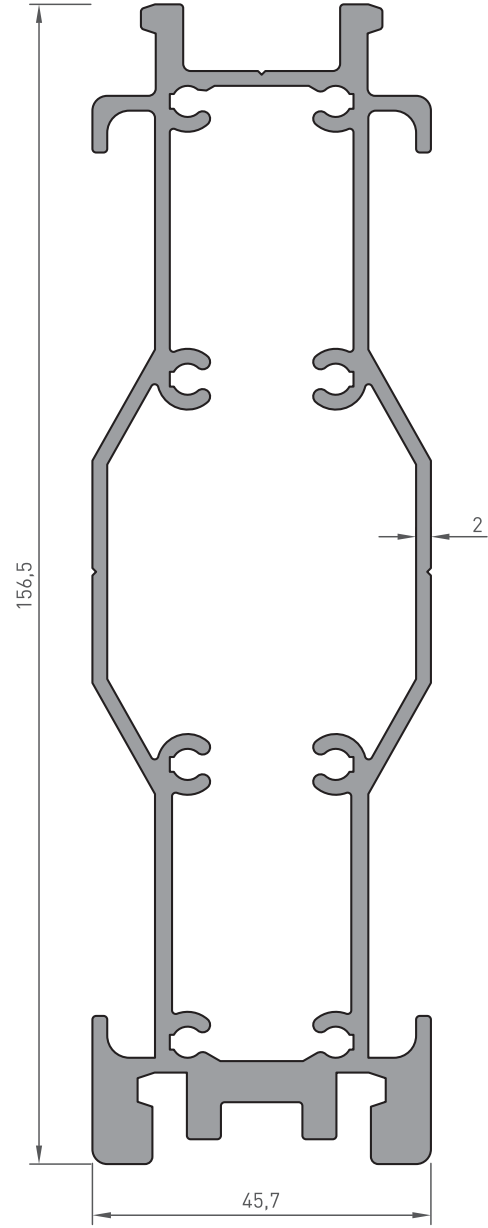
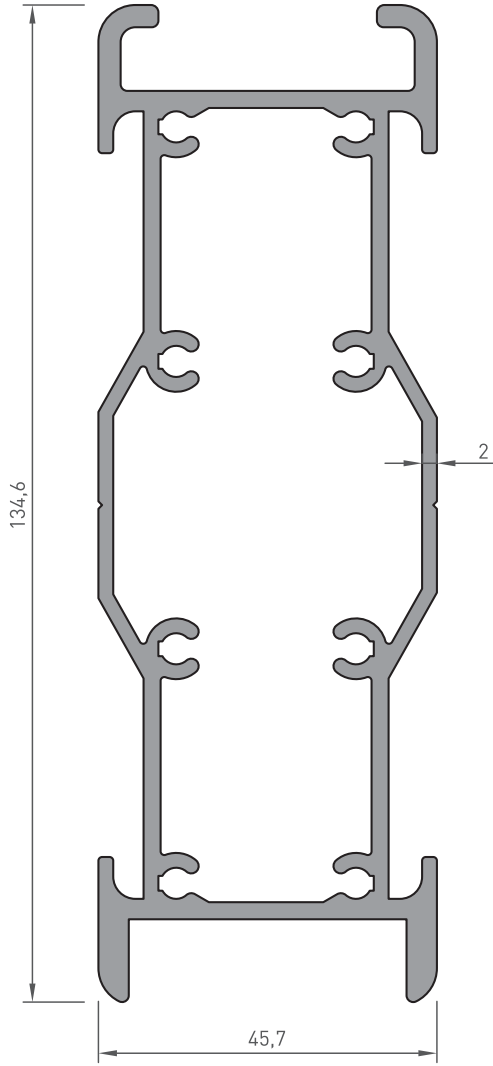

PROFİL KODU	1043
Tanım:	Cephe Bağlantı
Ağırlık:	3.030 kg/m
Jy:	31.54 cm <sup>4</sup>
Jx:	213.83 cm <sup>4</sup>

PROFİL KODU	1000-116
Tanım:	Cephe Bağlantı
Ağırlık:	3.675 kg/m
Jy:	31.59 cm <sup>4</sup>
Jx:	390.41 cm <sup>4</sup>

# MK CEPHE 50

## MK FACADE 50

### PROFİL KESİT DETAYLARI

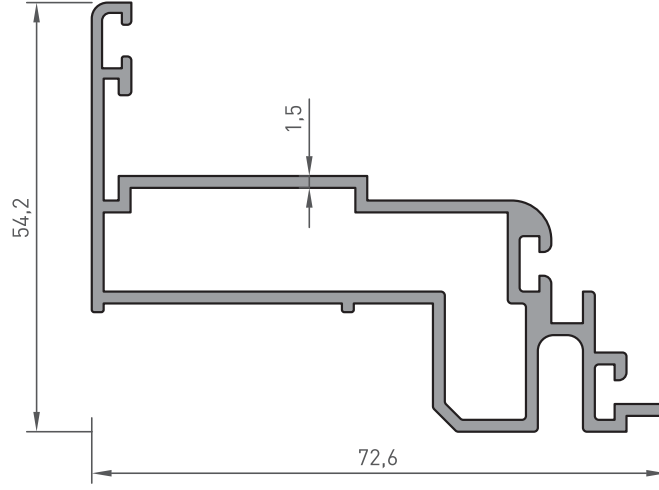

PROFİL KODU	1000-103
Tanım:	Cephe Askı Kanat
Ağırlık:	1.075 kg/m

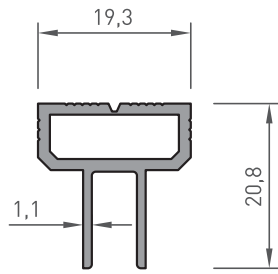

PROFİL KODU	1000-104
Tanım:	Isı Cam Ara Çıtası
Ağırlık:	0.260 kg/m

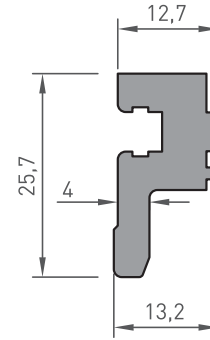

PROFİL KODU	1000-105
Tanım:	Montaj Profili
Ağırlık:	0.515 kg/m

\*BELİRTİLEN AĞIRLIKLAR, TEORİK PRES ÇIKIŞ AĞIRLIKLARIDIR.  
\*BOYALI PROFİLLERDE AĞIRLIĞA %5 İLAVE EDİLMESİ GEREKLİDİR.

# MK CEPHE 50

## MK FACADE 50

### PROFİL KESİT DETAYLARI

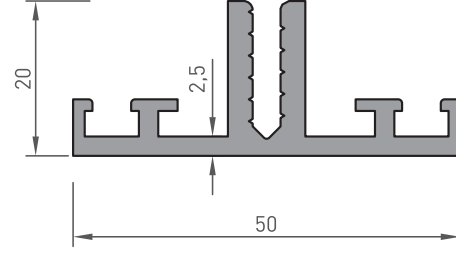
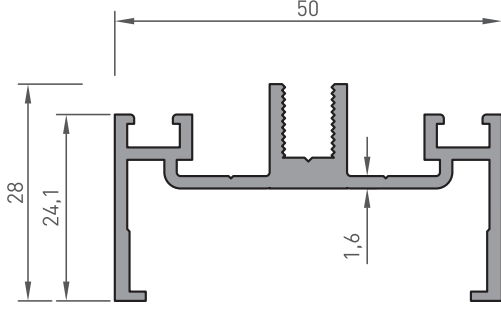

PROFİL KODU	1000-106
Tanım:	Cephe Açık Kasa
Ağırlık:	0.690 kg/m

PROFİL KODU	1000-107
Tanım:	Cephe Alt
Ağırlık:	0.780 kg/m

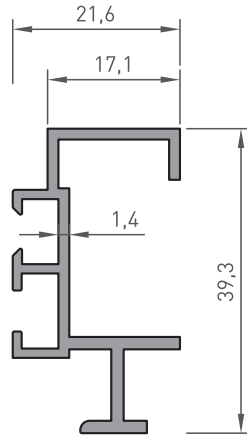

PROFİL KODU	1000-108
Tanım:	Cephe Açık Kasa
Ağırlık:	0.415 kg/m

# MK CEPHE 50

## MK FACADE 50

### PROFİL KESİT DETAYLARI

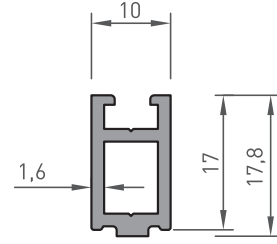
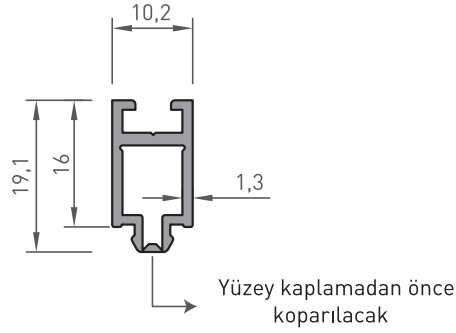

PROFİL KODU	1000-110
Tanım:	Tek Cam Çıtası
Ağırlık:	0.190 kg/m

PROFİL KODU	1000-111
Tanım:	Cephe Cam Çıtası
Ağırlık:	0.220 kg/m

\*BELİRTİLEN AĞIRLIKLAR, TEORİK PRES ÇIKIŞ AĞIRLIKLARIDIR.  
\*BOYALI PROFİLLERDE AĞIRLIĞA %5 İLAVE EDİLMESİ GEREKLİDİR.

# MK CEPHE 50

## MK FACADE 50

### PROFİL KESİT DETAYLARI

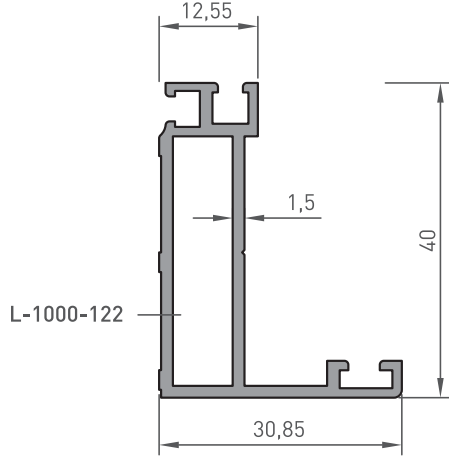

PROFİL KODU	1000-112
Tanım:	Kanat Kasa Cam Cephe
Ağırlık:	0.515 kg/m
Jy:	0.96 cm <sup>4</sup>
Jx:	3.96 cm <sup>4</sup>
Köşe Takozu:	 1000-122 Kesim Ölçüsü 31.2mm

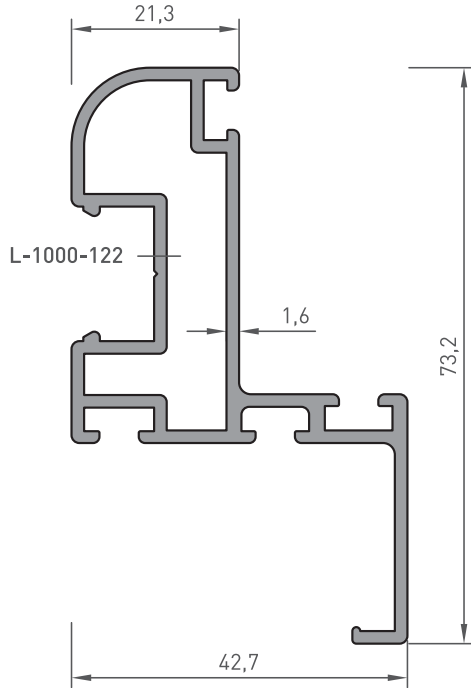

PROFİL KODU	1000-113
Tanım:	Sabit Cam Çerçeve Cam Cephe
Ağırlık:	1.025 kg/m
Jy:	3.64 cm <sup>4</sup>
Jx:	16.94 cm <sup>4</sup>
Köşe Takozu:	 1000-122 Kesim Ölçüsü 34.8mm



# MK CEPHE 50

## MK FACADE 50

### PROFİL KESİT DETAYLARI

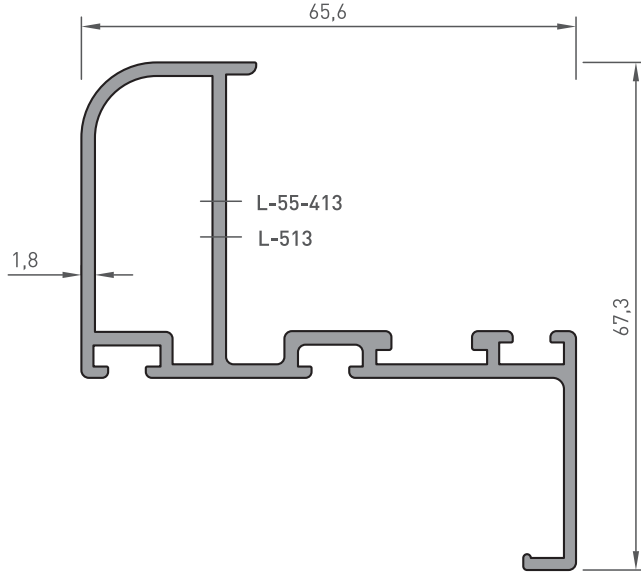

PROFİL KODU	1000-115	
Tanım:	Kanat Çerçeve Cam Cephe	
Ağırlık:	1.085 kg/m	
Jy:	4.91 cm <sup>4</sup>	
Jx:	26.37 cm <sup>4</sup>	
Köşe Takozu:	55-413	Kesim Ölçüsü 25.3mm
Köşe Bağlantı:	513	

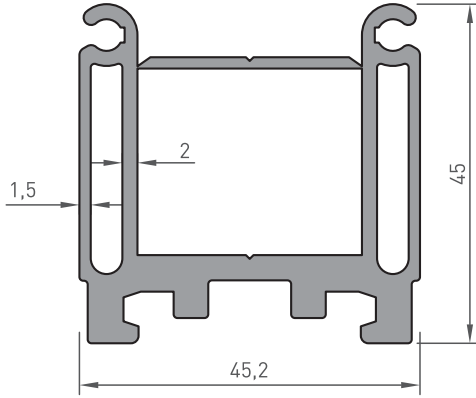

PROFİL KODU	1000-263
Tanım:	Cephe Bağlantı Yatay
Ağırlık:	1.570 kg/m

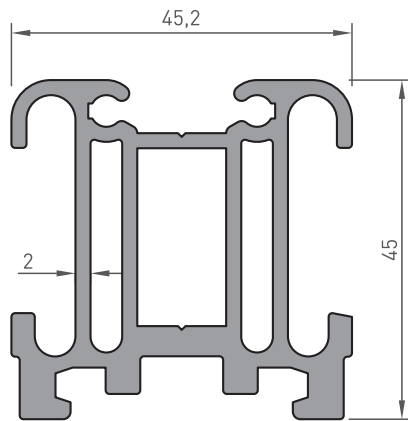

PROFİL KODU	1000-117
Tanım:	Cephe Bağlantı Yatay
Ağırlık:	1.745 kg/m

\*BELİRTİLEN AĞIRLIKLAR, TEORİK PRES ÇIKIŞ AĞIRLIKLARIDIR.  
\*BOYALI PROFİLLERDE AĞIRLIĞA %5 İLAVE EDİLMESİ GEREKLİDİR.

# MK CEPHE 50

## MK FACADE 50

### PROFİL KESİT DETAYLARI

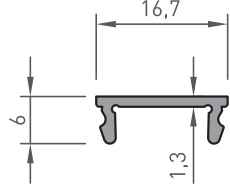

PROFİL KODU	1000-114
Tanım:	Çerçeve Çita Cam Cephe
Ağırlık:	0.095 kg/m

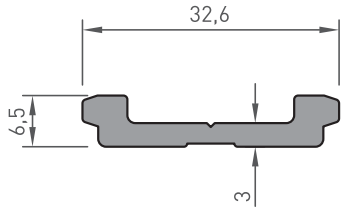

PROFİL KODU	1000-118
Tanım:	Çerçeve Bağlantı Yatay Çitası
Ağırlık:	0.330 kg/m

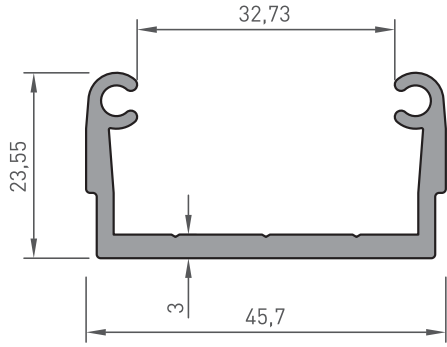

PROFİL KODU	1000-119
Tanım:	'U' Bağlantı Profili
Ağırlık:	0.690 kg/m

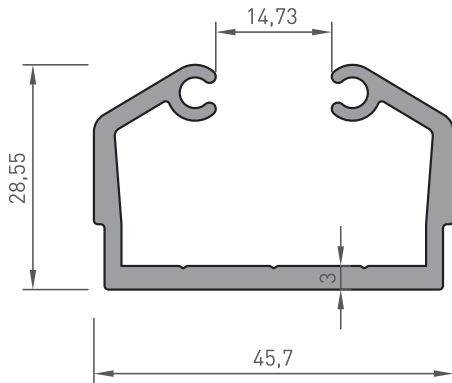

PROFİL KODU	1020
Tanım:	'U' Bağlantı Profili
Ağırlık:	0.865 kg/m

# MK CEPHE 50

## MK FACADE 50

### PROFİL KESİT DETAYLARI

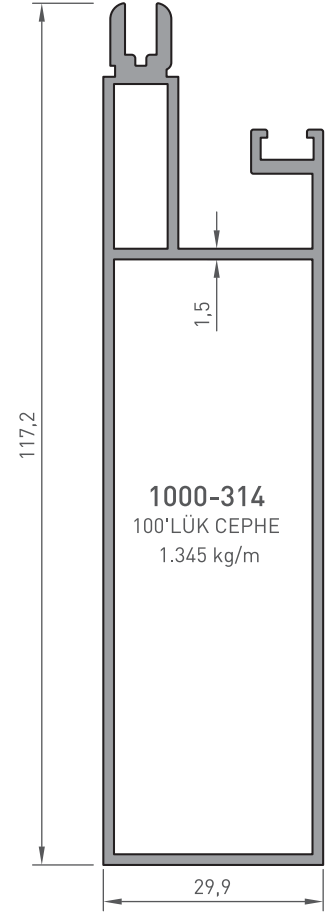
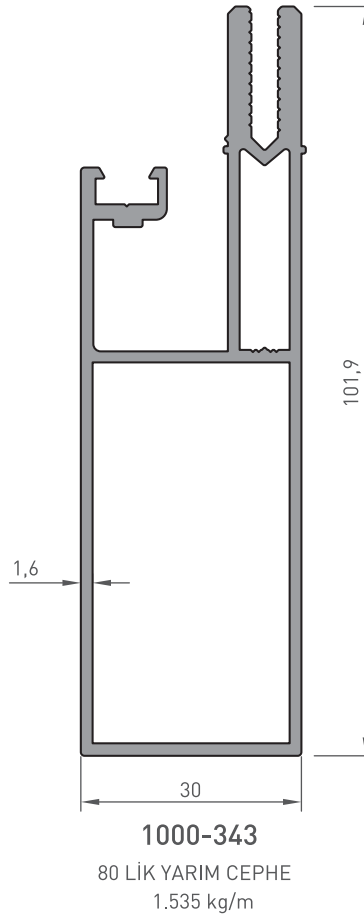
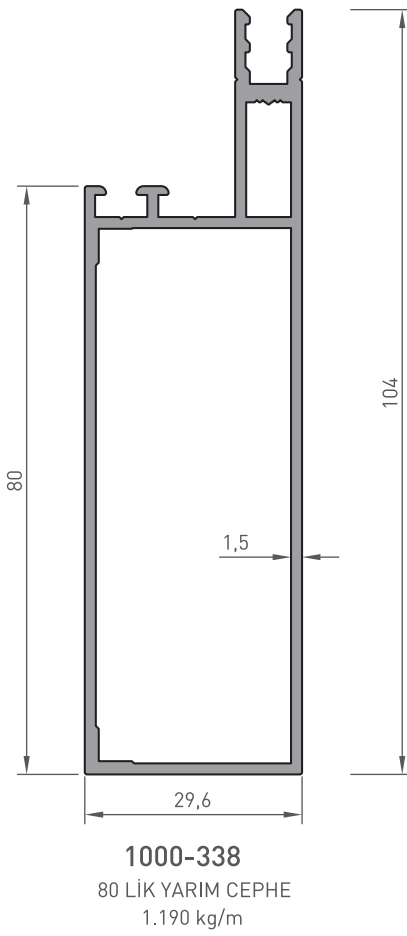
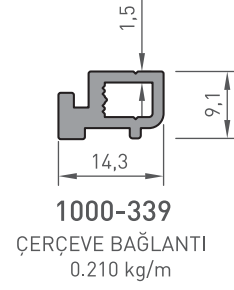
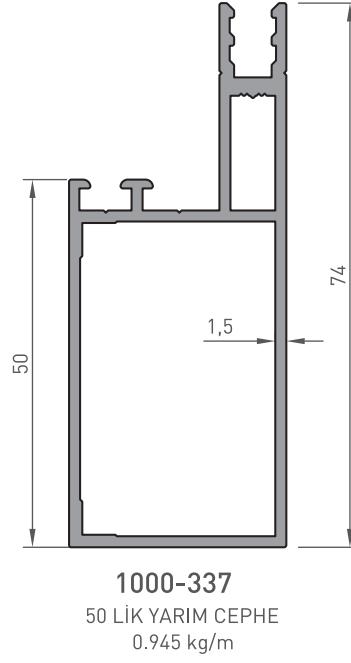
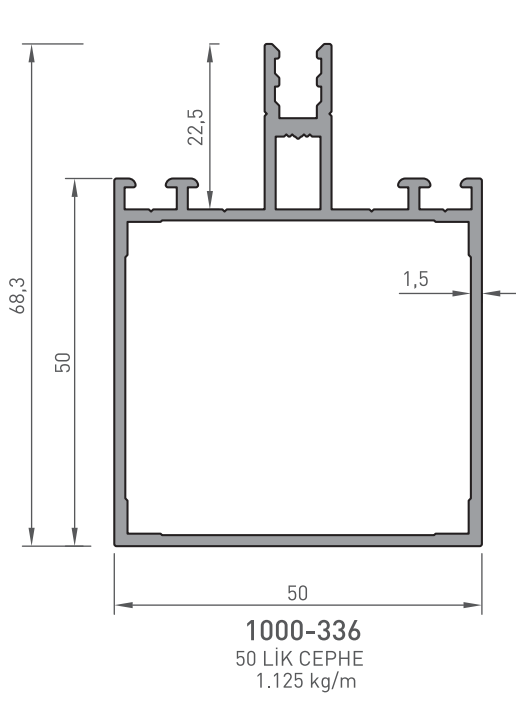

\*BELİRTİLEN AĞIRLIKLAR, TEORİK PRES ÇIKIŞ AĞIRLIKLARIDIR.  
\*BOYALI PROFİLLERDE AĞIRLIĞA %5 İLAVE EDİLMESİ GEREKLİDİR.

# MK CEPHE 50

## MK FACADE 50

### PROFİL KESİT DETAYLARI

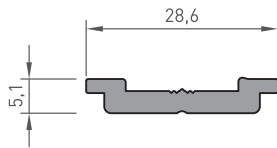
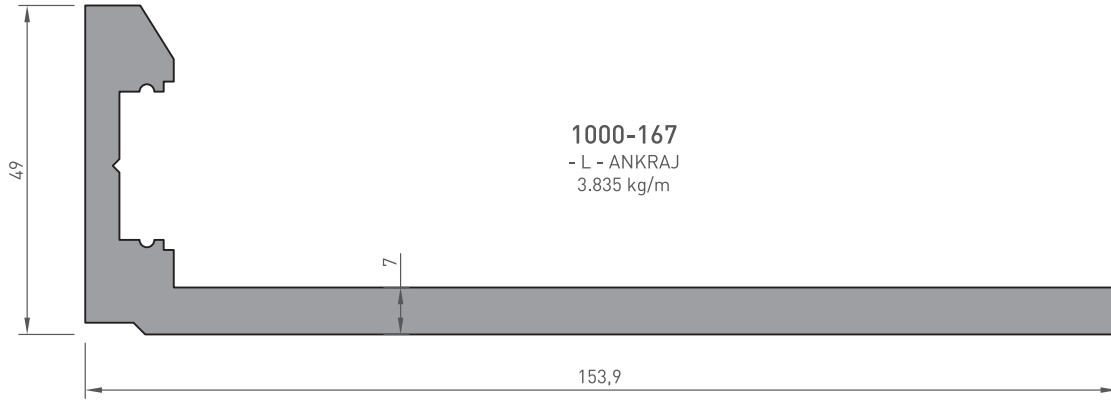
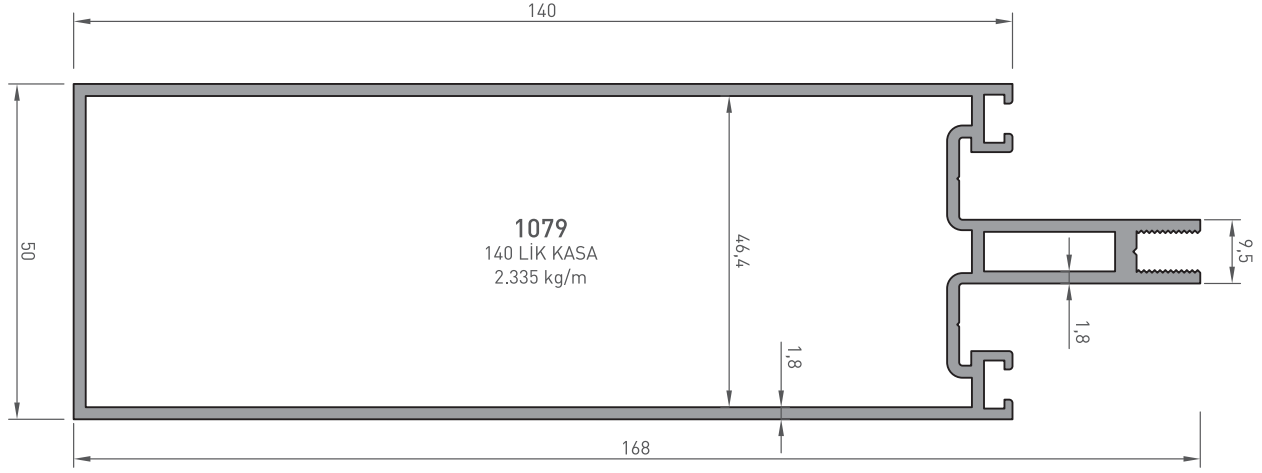

**1000-349**  
TİJ  
0.285 kg/m

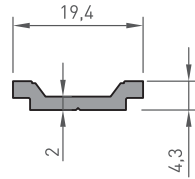

**1042**  
TİJ ÇUBUĞU  
0.135 kg/m

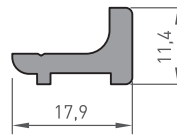

**1039**  
CEPHE PRF.  
0.240 kg/m

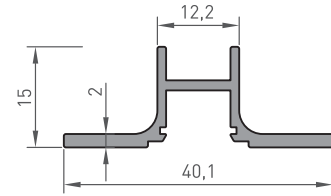

**1028**  
KAPAMA PRF.  
0.300 kg/m

# MK CEPHE 50

## MK FACADE 50

### PROFİL KESİT DETAYLARI

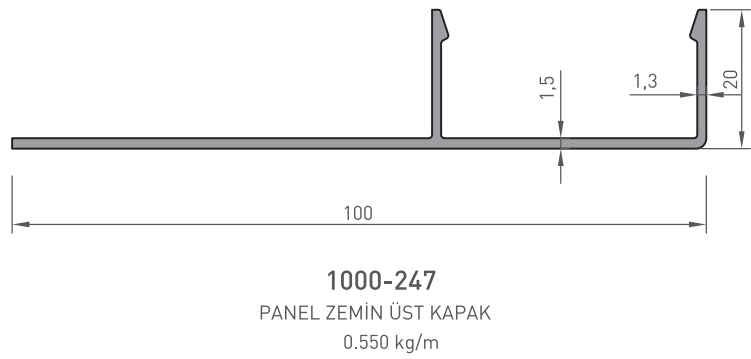
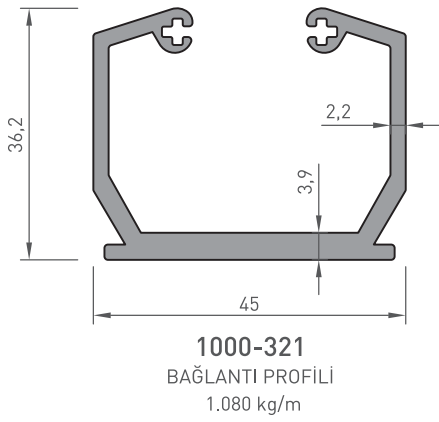
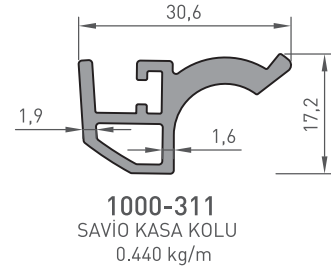
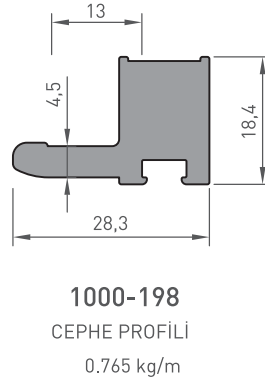
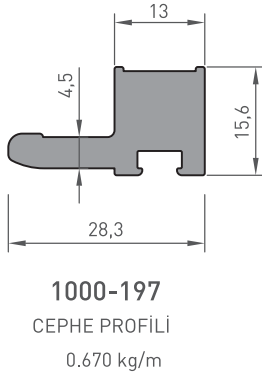
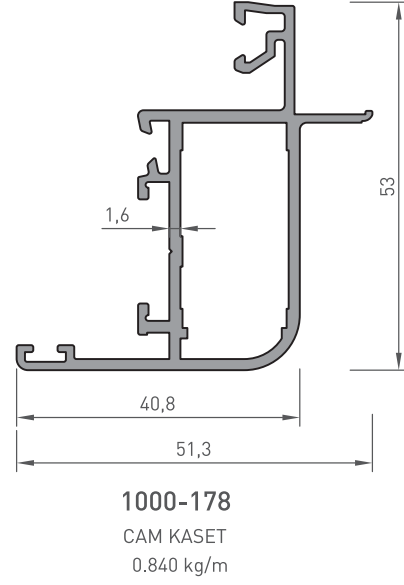
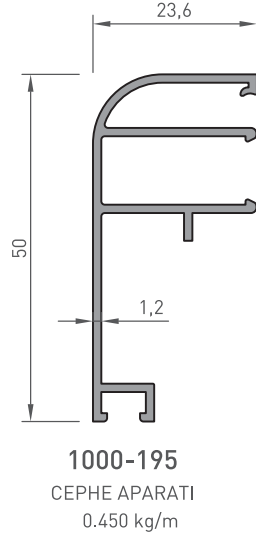
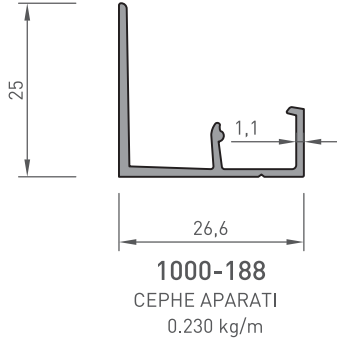

\*BELİRTİLEN AĞIRLIKLAR, TEORİK PRES ÇIKIŞ AĞIRLIKLARIDIR.  
\*BOYALI PROFİLLERDE AĞIRLIĞA %5 İLAVE EDİLMESİ GEREKLİDİR.

# MK CEPHE 50

## MK FACADE 50

### PROFİL KESİT DETAYLARI

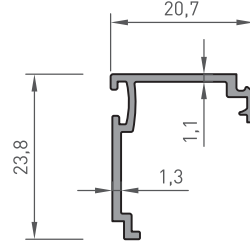

**1000-204**  
CEPHE PROFİLİ  
0.190 kg/m

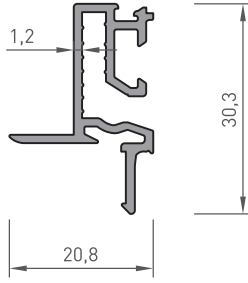

**1000-206**  
KASET  
0.305 kg/m

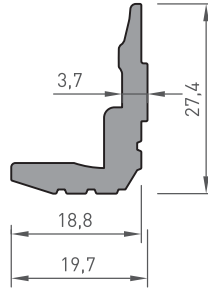

**1000-207**  
CEPHE PROFİLİ  
0.435 kg/m

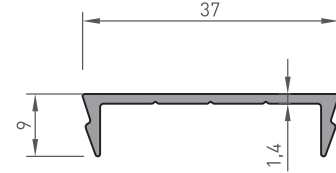

**1000-246**  
PANEL ZEMİN ÜST KAPAK ÇITASI  
0.205 kg/m

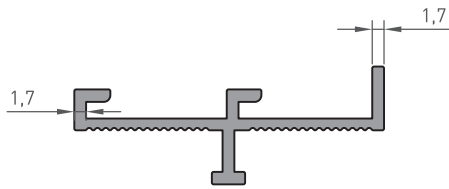

**1000-276**  
CEPHE PROFİLİ  
0.360 kg/m

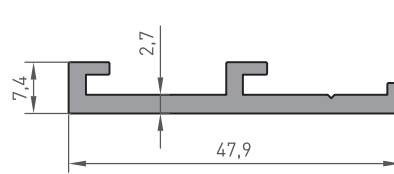

**1000-277**  
CEPHE PROFİLİ  
0.475 kg/m

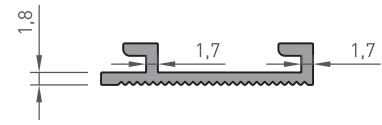

**1000-278**  
CEPHE PROFİLİ  
0.215 kg/m

# MK CEPHE 50

## MK FACADE 50

### PROFİL KESİT DETAYLARI

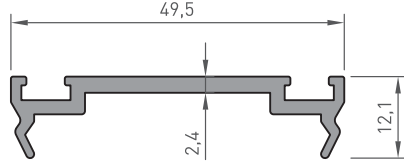

**1000-330**  
KAPAK ALTI  
0.455 kg/m

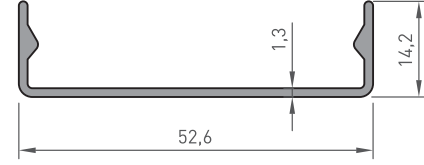

**1000-331**  
15 LİK KAPAK  
315 gr/m

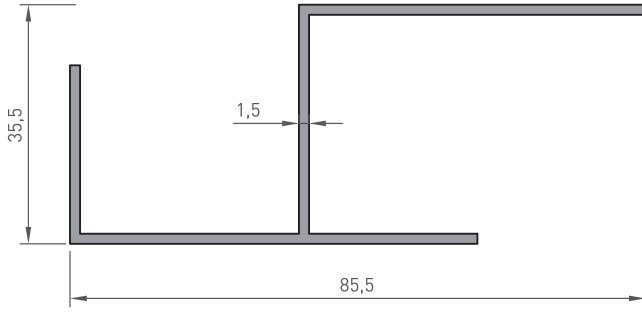

**1000-323**  
DIŞ CEPHE PROFİLİ  
0.710 kg/m

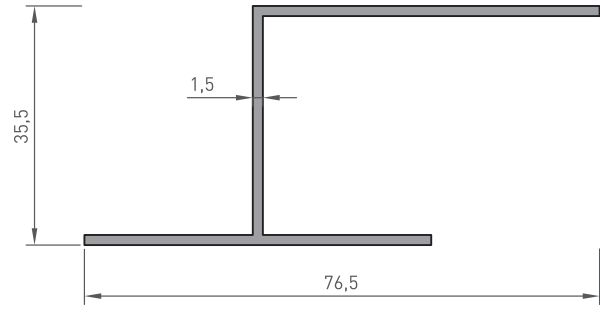

**1000-324**  
DIŞ CEPHE PROFİLİ  
0.570 kg/m

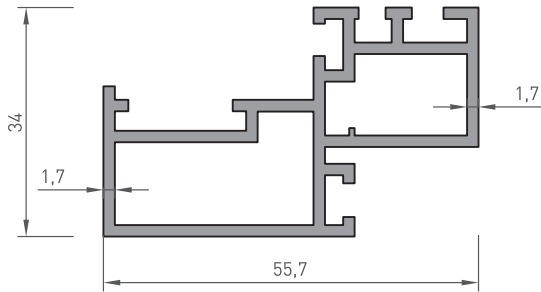

**1000-322**  
KASET  
1.020 kg/m

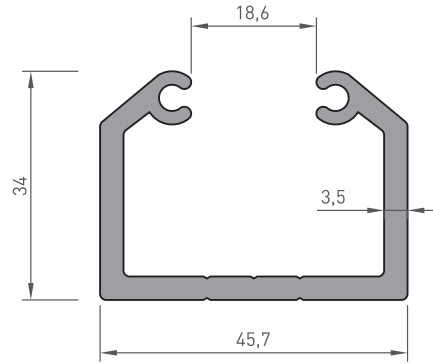

**1076**  
CEPHE BAĞLANTI PROFİLİ  
1.140 kg/m

\*BELİRTİLEN AĞIRLIKLAR, TEORİK PRES ÇIKIŞ AĞIRLIKLARIDIR.  
\*BOYALI PROFİLLERDE AĞIRLIĞA %5 İLAVE EDİLMESİ GEREKLİDİR.

# MK CEPHE 50

## MK FACADE 50

### PROFİL KESİT DETAYLARI

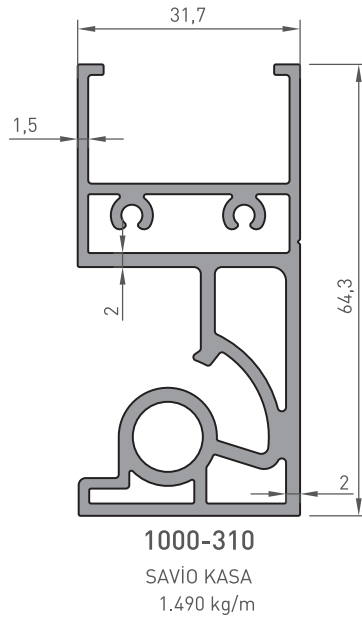
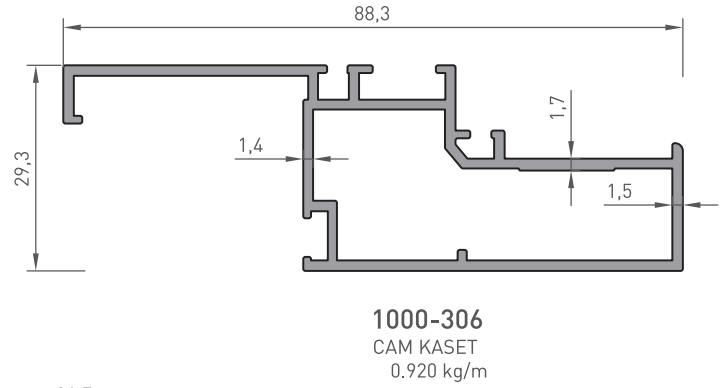
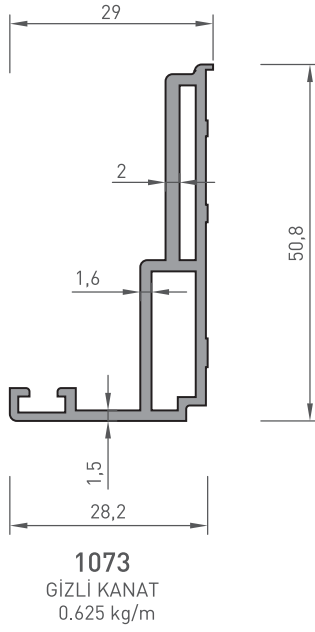
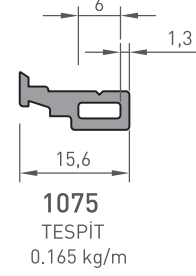
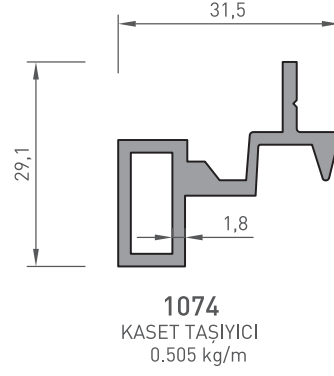
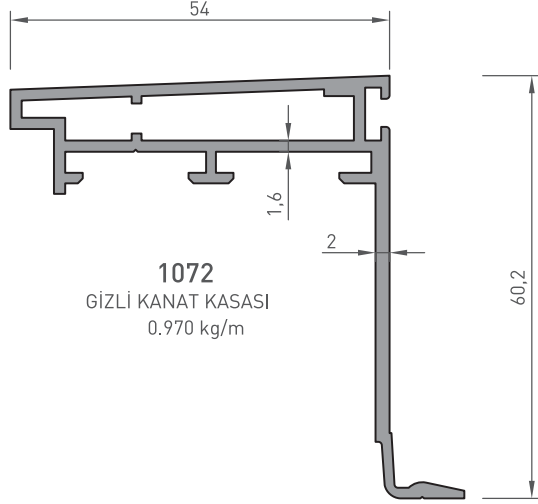



# MK CEPHE 50

## MK FACADE 50

### PROFİL KESİT DETAYLARI

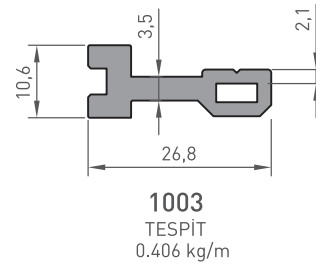
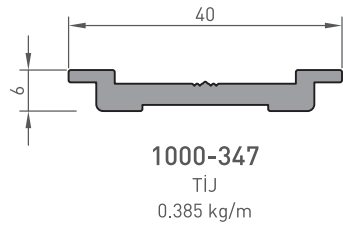
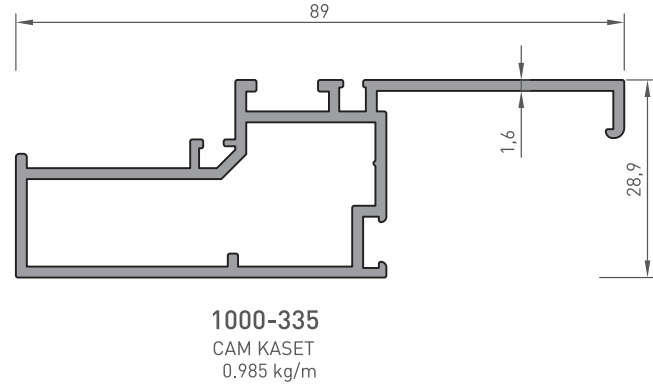
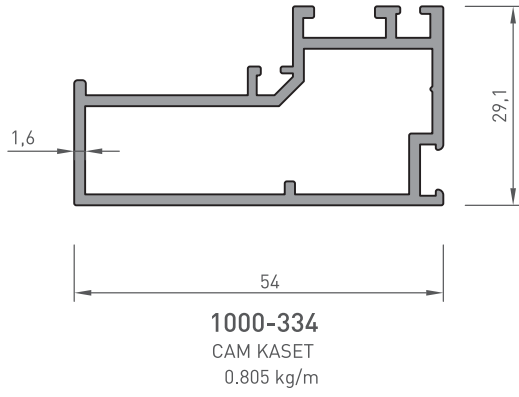
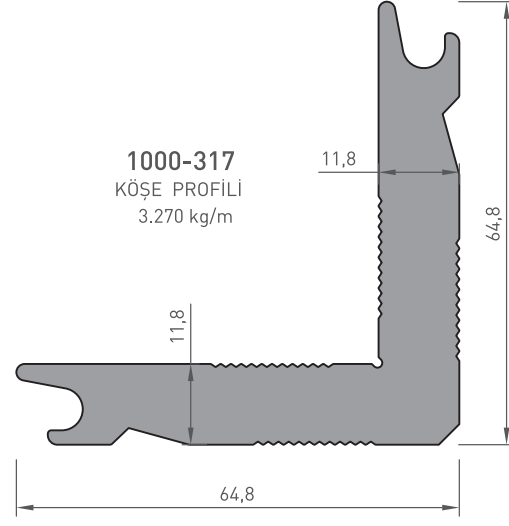
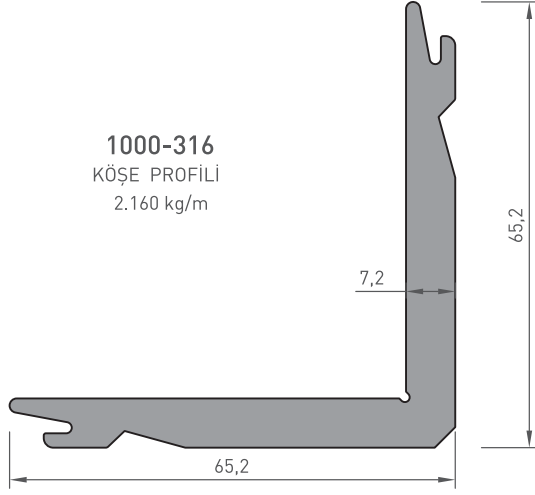

\*BELİRTİLEN AĞIRLIKLAR, TEORİK PRES ÇIKIŞ AĞIRLIKLARIDIR.  
\*BOYALI PROFİLLERDE AĞIRLIĞA %5 İLAVE EDİLMESİ GEREKLİDİR.

# MK CEPHE 50

## MK FACADE 50

### PROFİL KESİT DETAYLARI

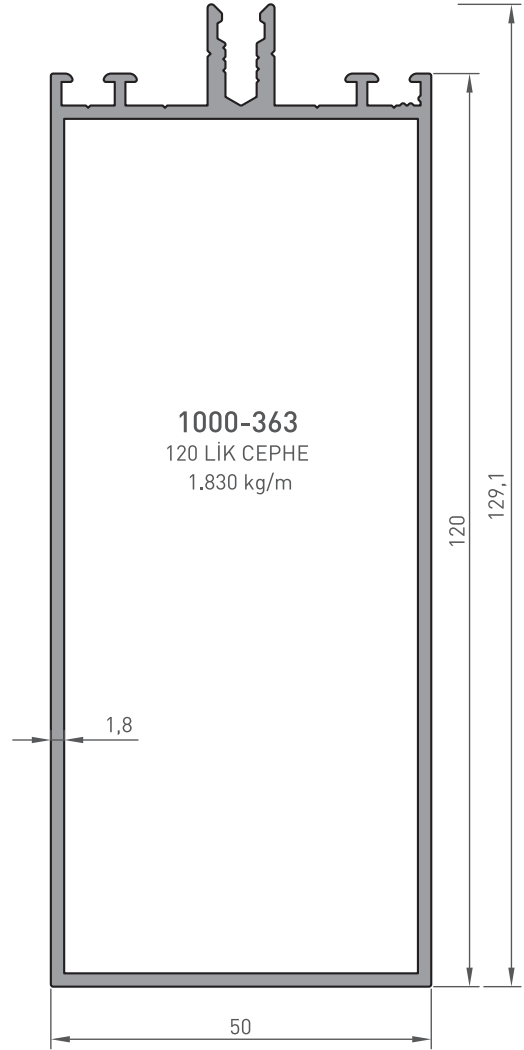
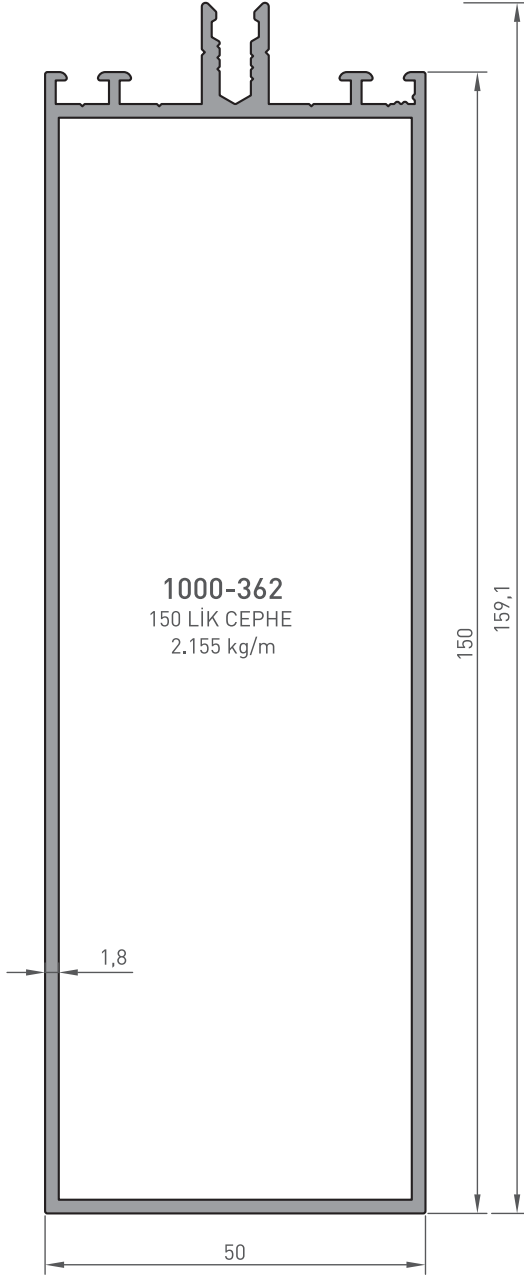

# MK CEPHE 50

## MK FACADE 50

### PROFİL KESİT DETAYLARI

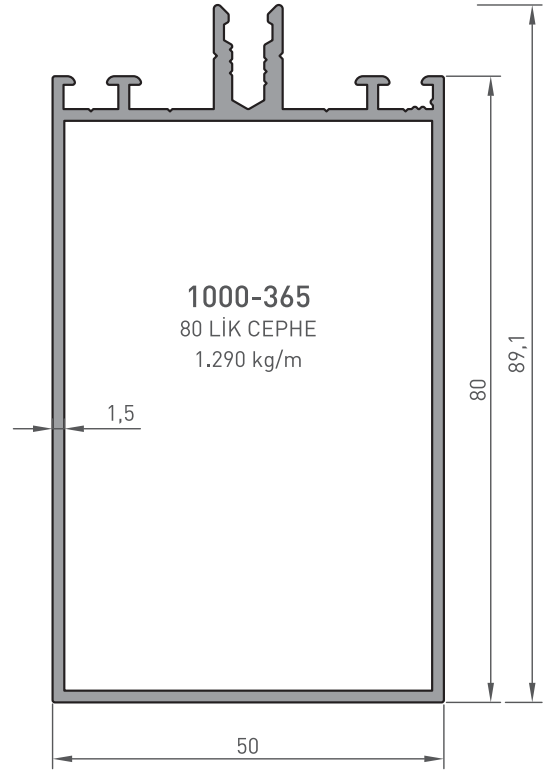
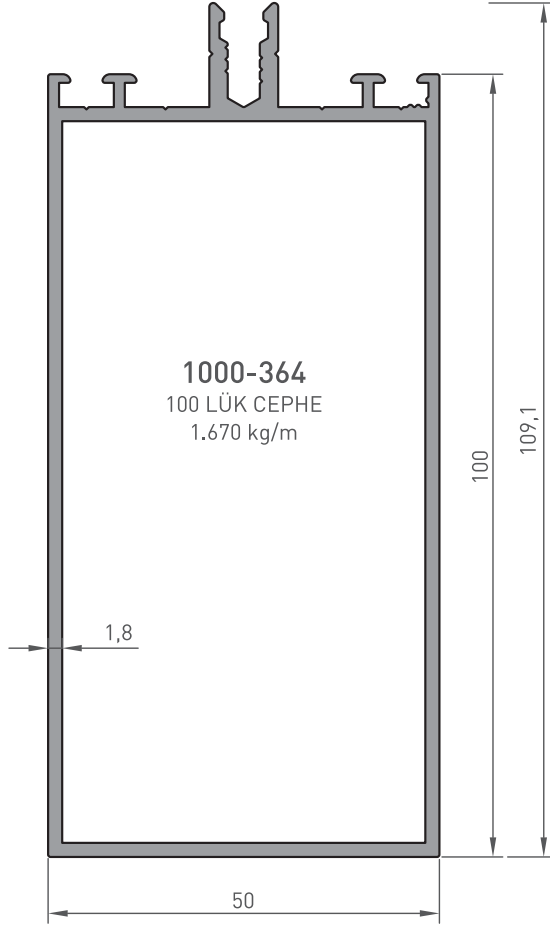

\*BELİRTİLEN AĞIRLIKLAR, TEORİK PRES ÇIKIŞ AĞIRLIKLARIDIR.  
\*BOYALI PROFİLLERDE AĞIRLIĞA %5 İLAVE EDİLMESİ GEREKLİDİR.

# MK CEPHE 50

## MK FACADE 50

### PROFİL KESİT DETAYLARI

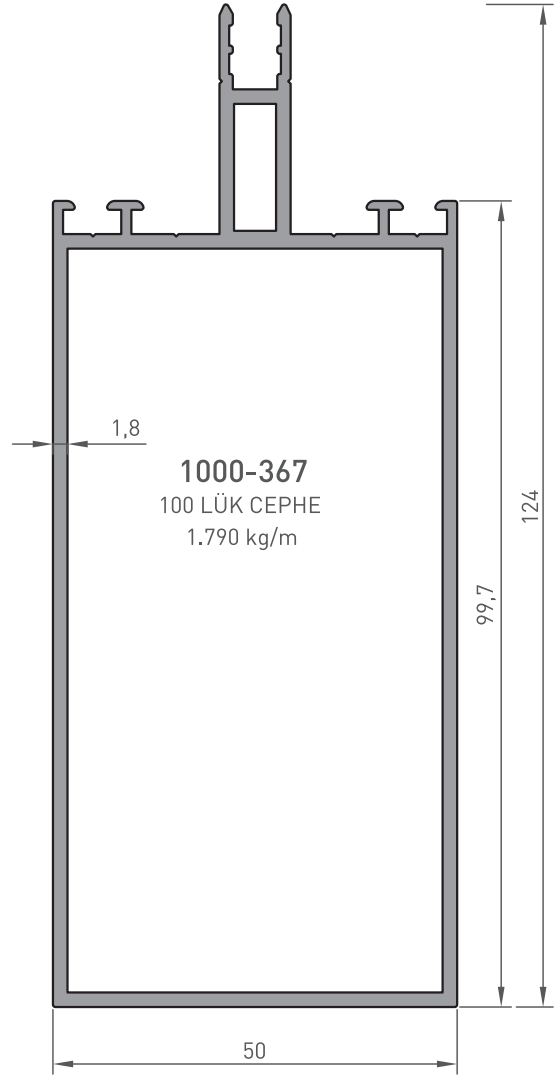
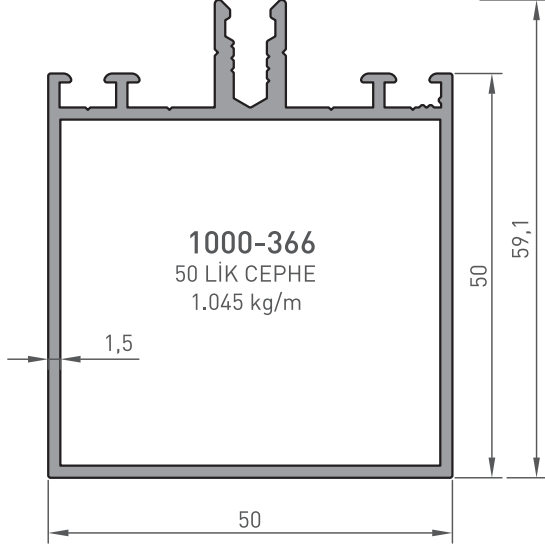

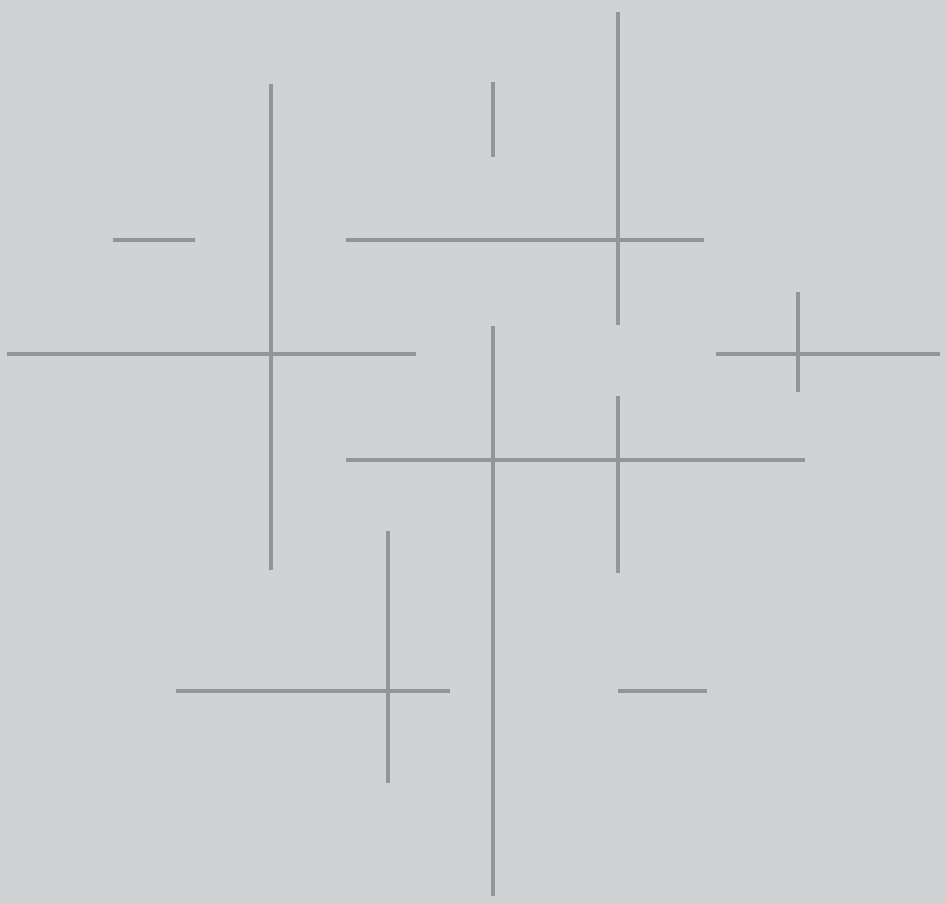

## **MK CEPHE 50**

MK FACADE 50

**77-90**

**KAPAKLI DETAYLARI**

COVERED DETAILS

# MK CEPHE 50

MK FACADE 50

## KAPAKLI DETAYLARI

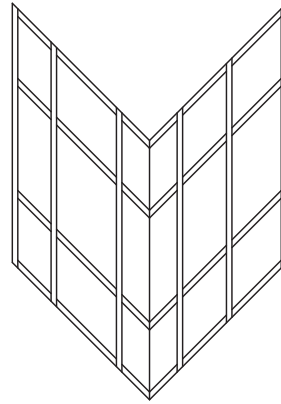
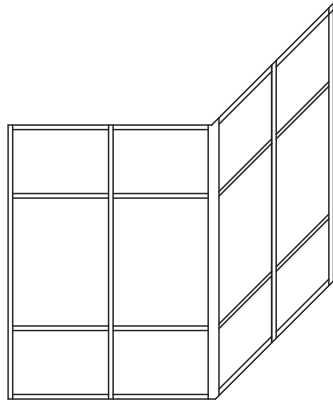
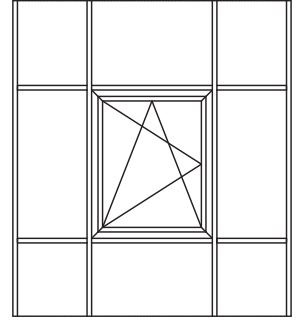
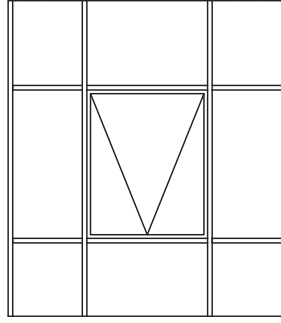
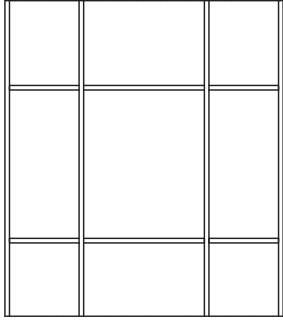

# MK CEPHE 50

## MK FACADE 50

### KAPAKLI DETAYLARI

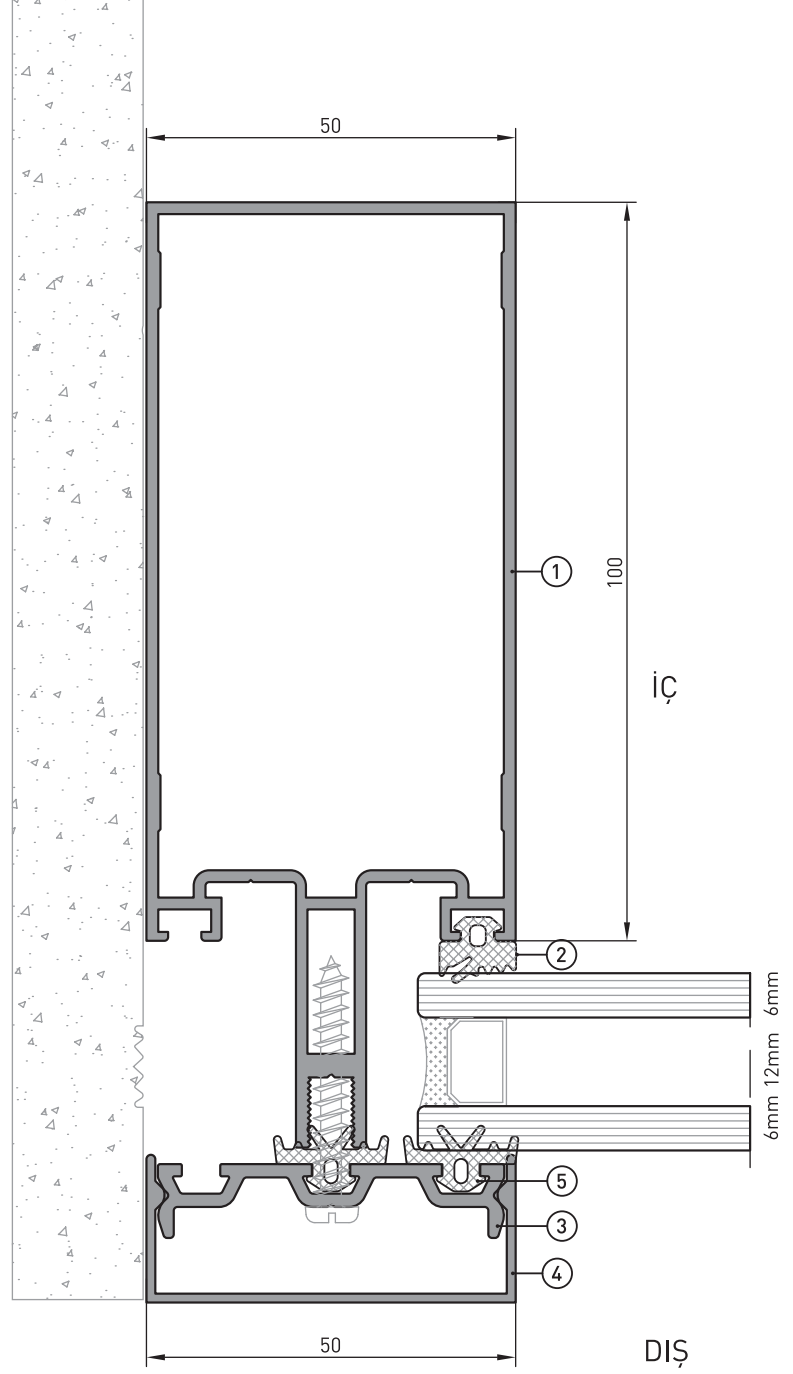
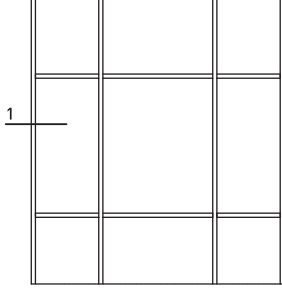

#### 1 DETAY

- ① 1018 - 100' LÜK KASA
- ② MK-52 - CAM CEPHE FİTİLİ
- ③ 1099 - KAPAK ALTI PROFİLİ
- ④ 1052 - 20' LİK KAPAK PROFİLİ
- ⑤ MK-16 - CEPHE KAPAK FİTİLİ

# MK CEPHE 50

## MK FACADE 50

### KAPAKLI DETAYLARI

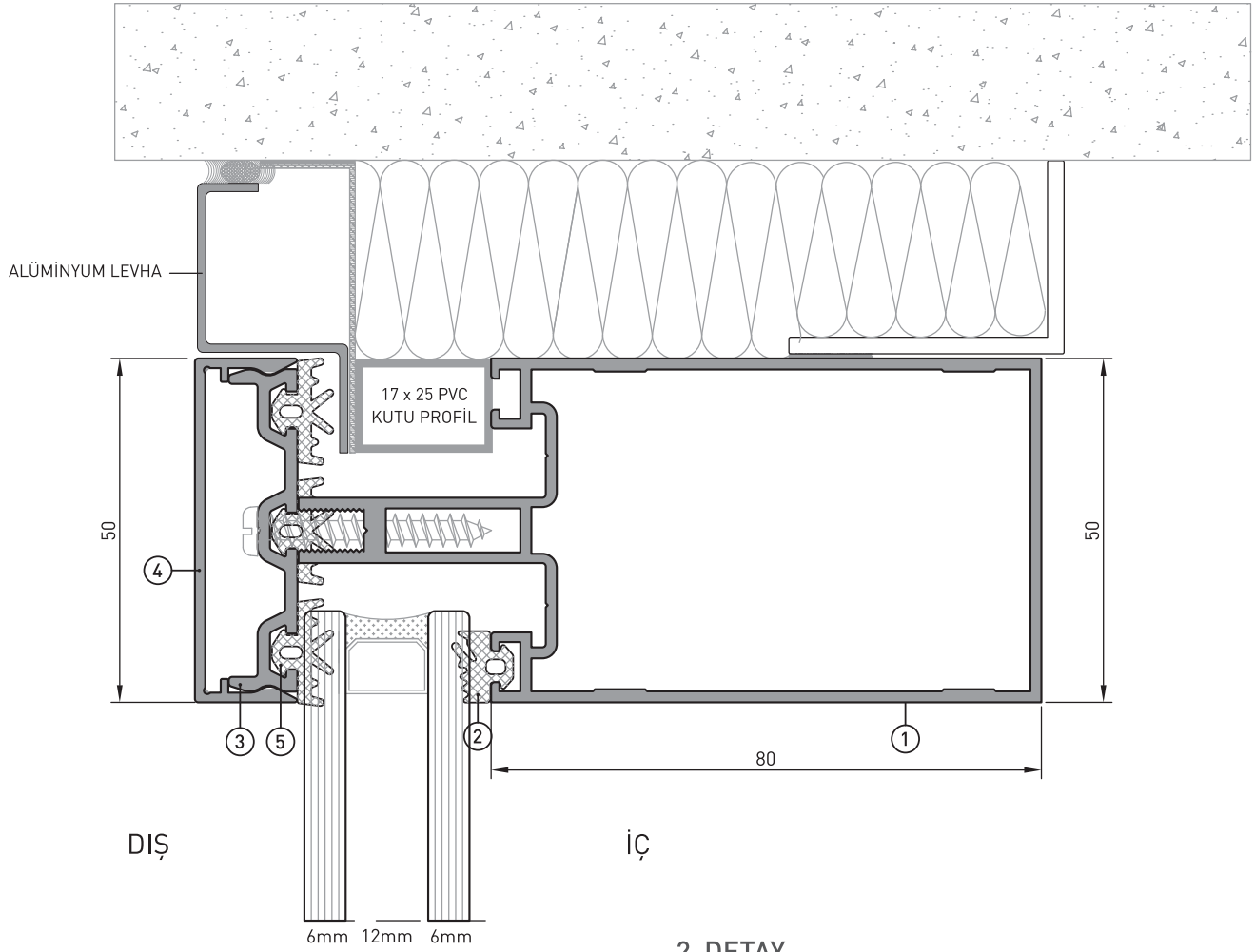
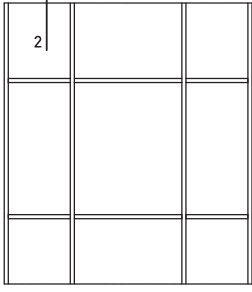

#### 2 DETAY

- ① - 1059 - 80' LİK KASA
- ② - MK-52 - CAM CEPHE FİTİLİ
- ③ - 1099 - KAPAK ALTI PROFİLİ
- ④ - 1098 - 15' LİK KAPAK PROFİLİ
- ⑤ - MK-16 - CEPHE KAPAK FİTİLİ



# MK CEPHE 50

## MK FACADE 50

### KAPAKLI DETAYLARI

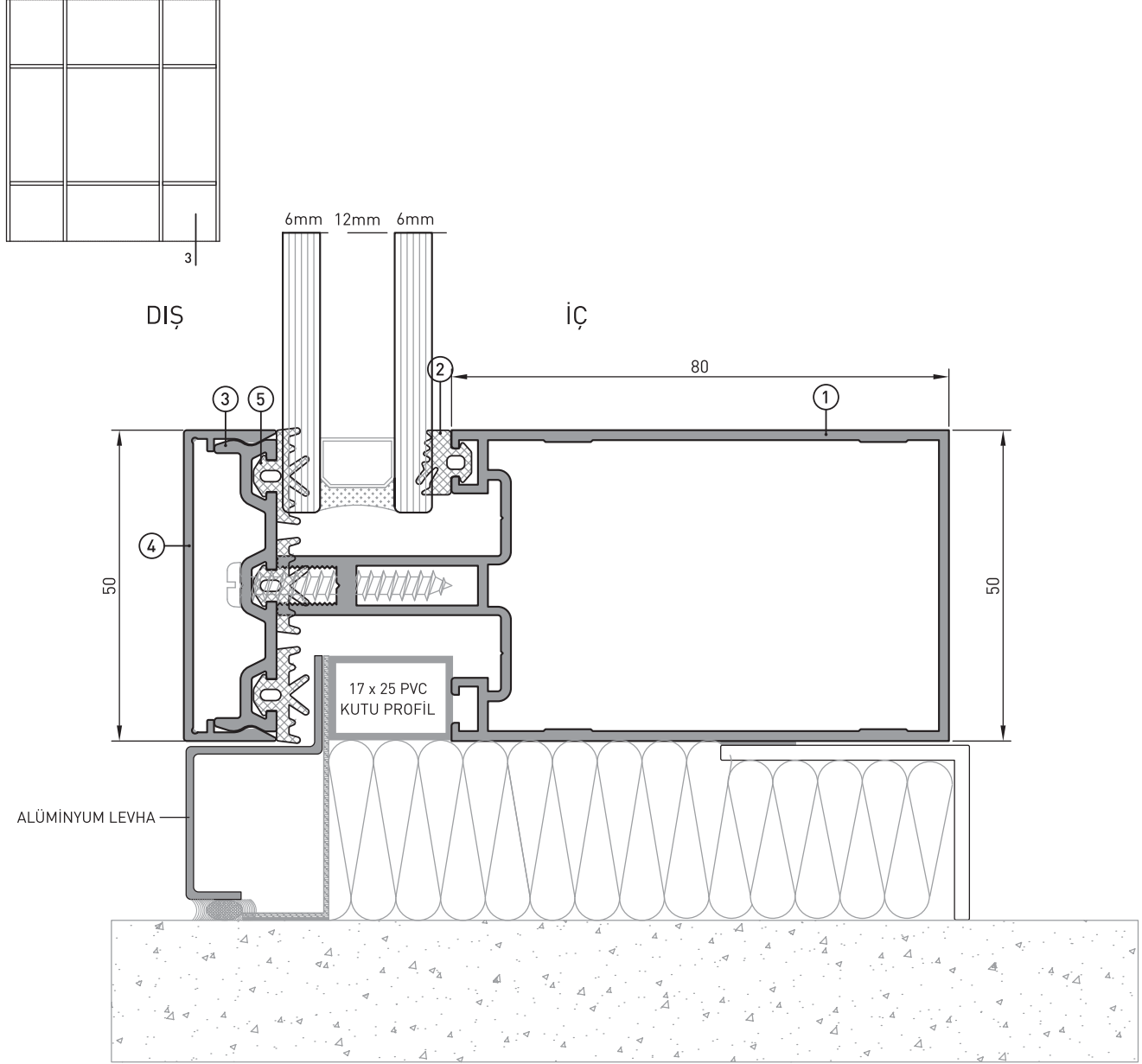

### 3 DETAY

- ① - 1059 - 80' LİK KASA
- ② - MK-52 - CAM CEPHE FİTİLİ
- ③ - 1099 - KAPAK ALTI PROFİLİ
- ④ - 1098 - 15' LİK KAPAK PROFİLİ
- ⑤ - MK-16 - CEPHE KAPAK FİTİLİ

# MK CEPHE 50

## MK FACADE 50

### KAPAKLI DETAYLARI

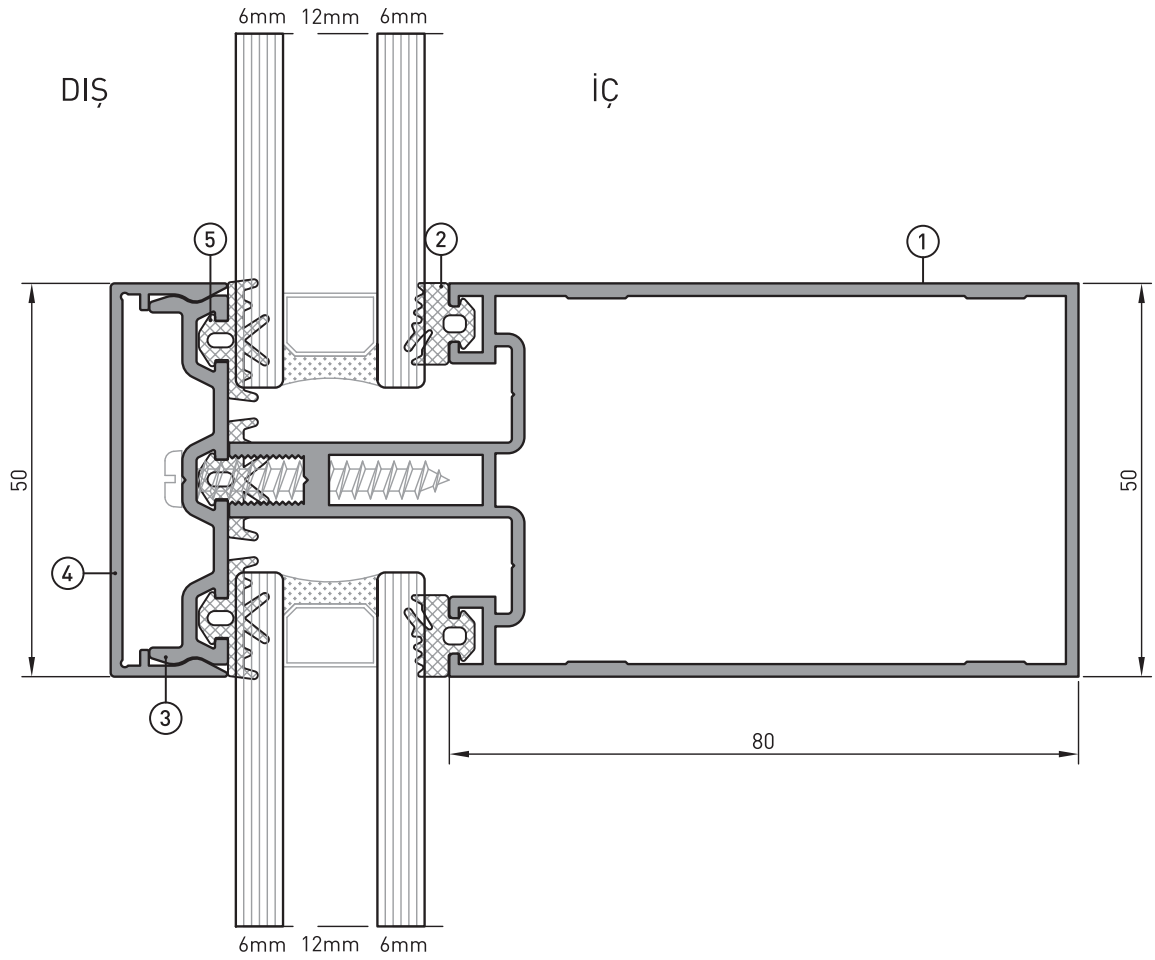
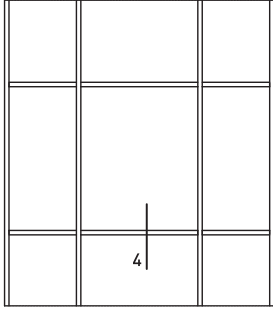

#### 4 DETAY

- ① - 1059 - 80' LİK KASA
- ② - MK-52 - CAM CEPHE FİTİLİ
- ③ - 1099 - KAPAK ALTI PROFİLİ
- ④ - 1098 - 15' LİK KAPAK PROFİLİ
- ⑤ - MK-16 - CEPHE KAPAK FİTİLİ

# MK CEPHE 50

## MK FACADE 50

### KAPAKLI DETAYLARI

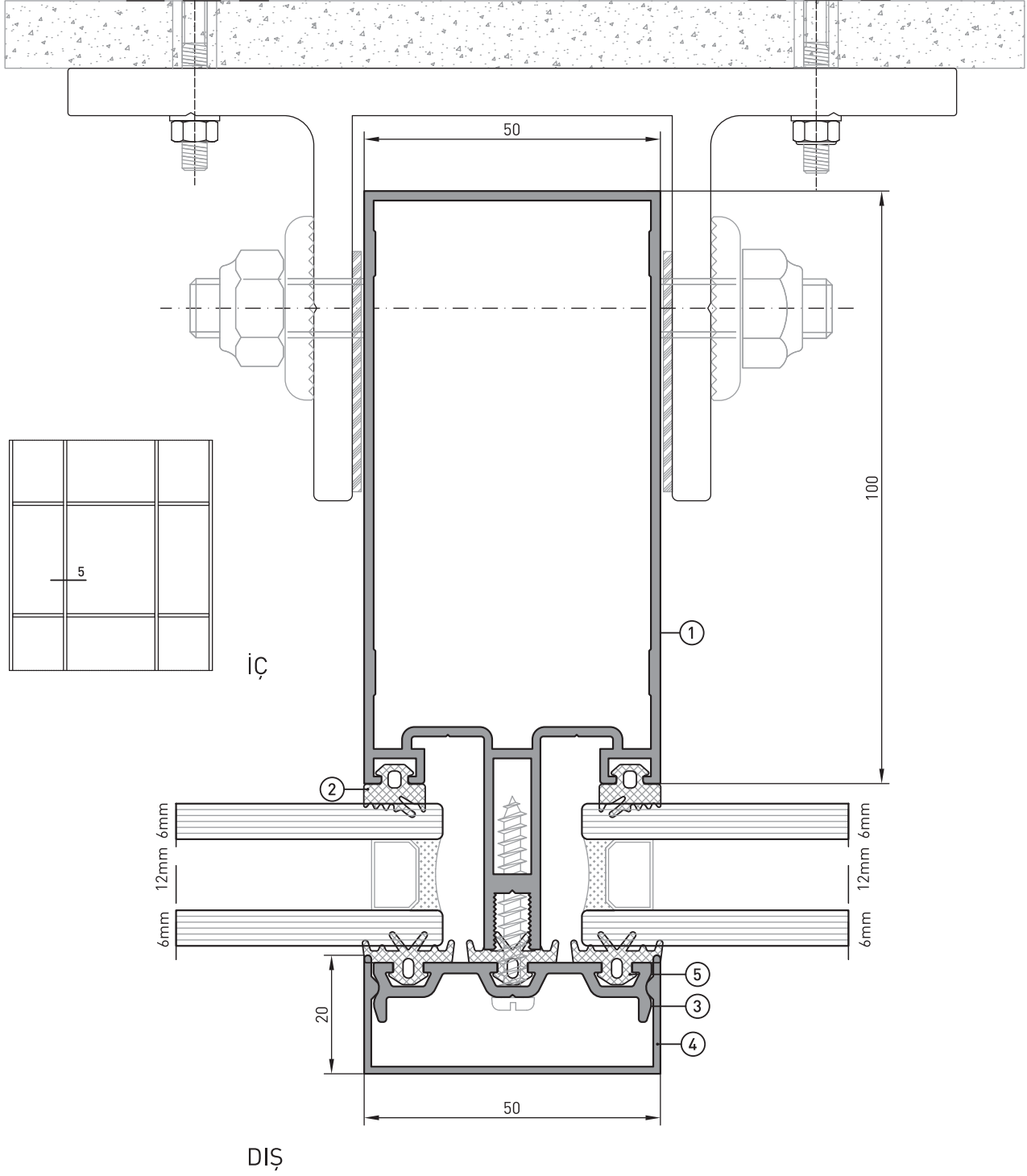

#### 5 DETAY

- ① - 1018 - 100' LÜK KASA
- ② - MK-52 - CAM CEPHE FİTİLİ
- ③ - 1099 - KAPAK ALTI PROFİLİ
- ④ - 1052 - 20' LİK KAPAK PROFİLİ
- ⑤ - MK-16 - CEPHE KAPAK FİTİLİ

# MK CEPHE 50

## MK FACADE 50

### KAPAKLI DETAYLARI

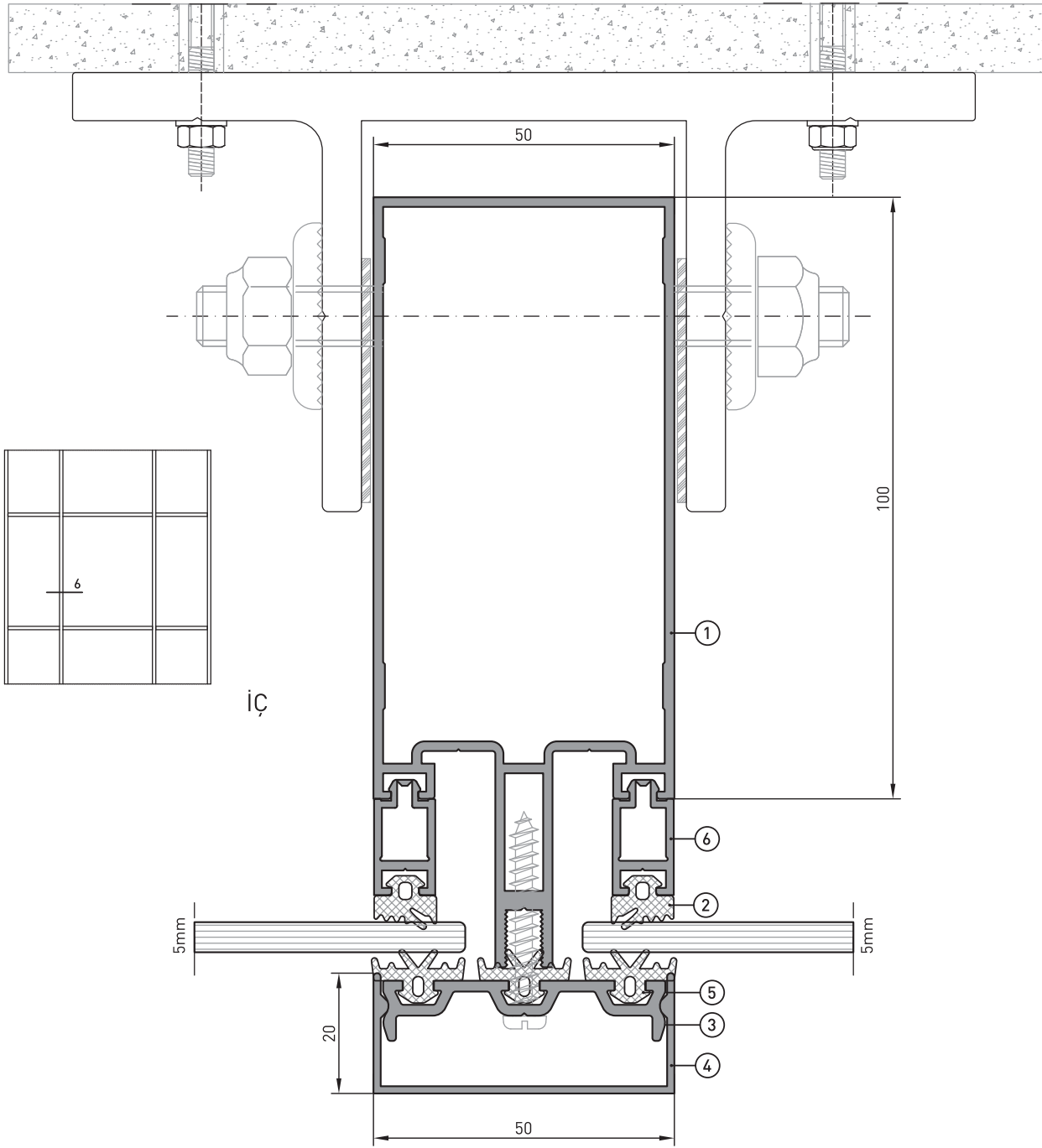

DIŞ

#### 6 DETAY

- ① - 1018 - 100' LÜK KASA
- ② - MK-52 - CAM CEPHE FİTİLİ
- ③ - 1099 - KAPAK ALTI PROFİLİ
- ④ - 1052 - 20' LİK KAPAK PROFİLİ
- ⑤ - MK-16 - CEPHE KAPAK FİTİLİ
- ⑥ - 1000-110 - TEK CAM ÇİTASI

# MK CEPHE 50

## MK FACADE 50

### KAPAKLI DETAYLARI

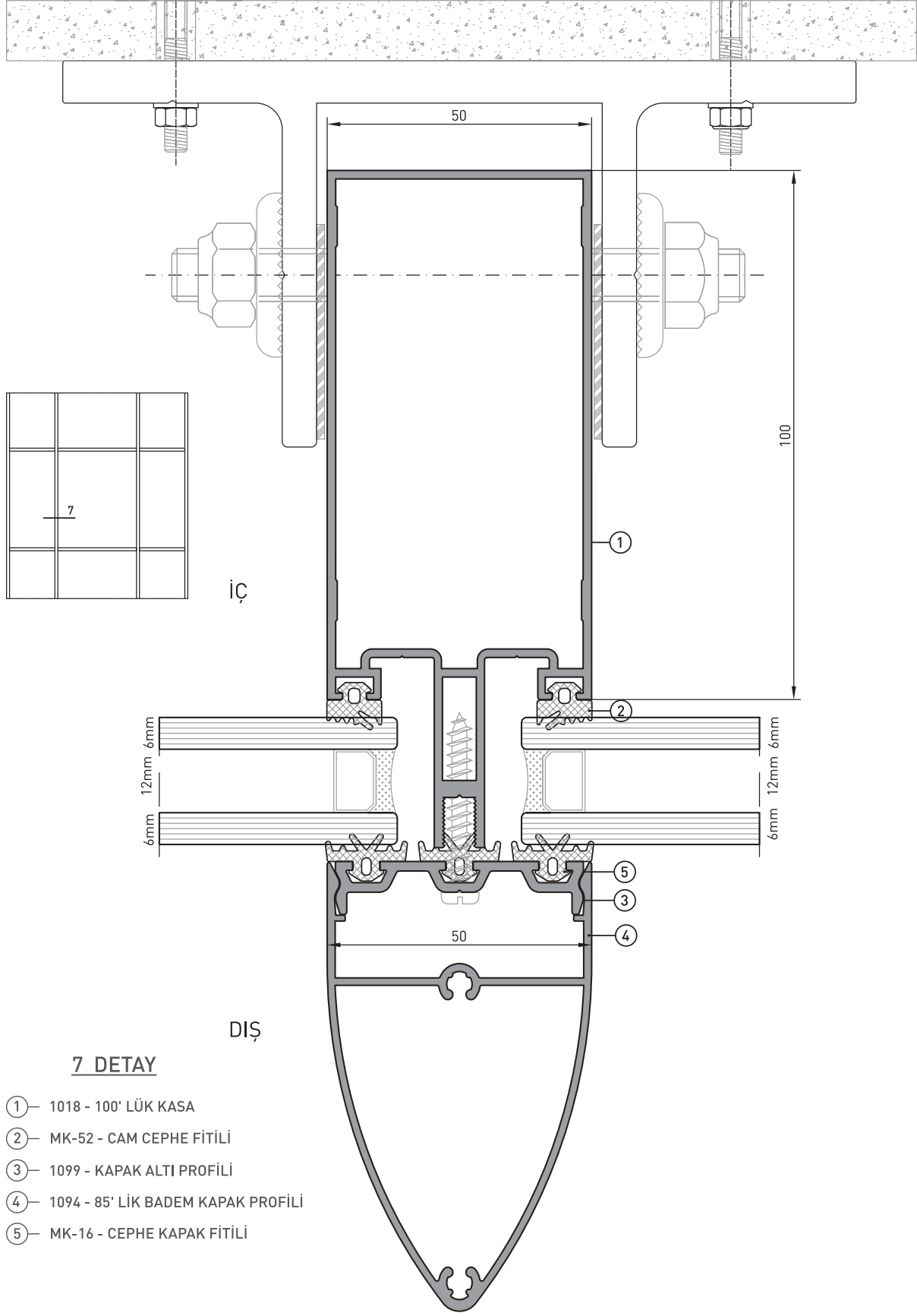

# MK CEPHE 50

## MK FACADE 50

### KAPAKLI DETAYLARI

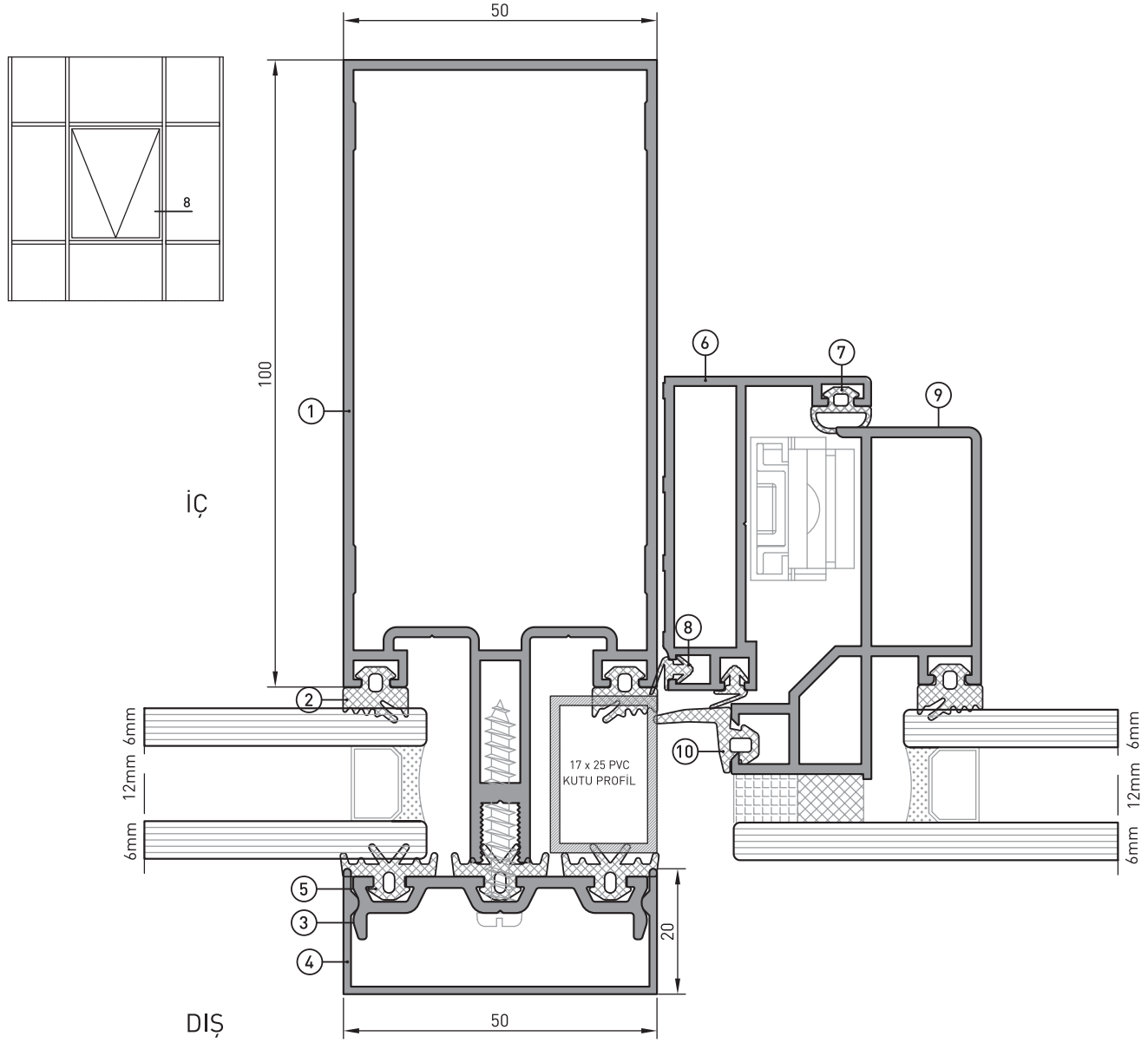

#### 8 DETAY

- |                                     |                                  |
|-------------------------------------|----------------------------------|
| ① — 1018 - 100' LÜK KASA            | ⑦ — 75-015 - BİNİ FİTİLİ         |
| ② — MK-52 - CAM CEPHE FİTİLİ        | ⑧ — MK-21 - BİNİ FİTİLİ          |
| ③ — 1099 - KAPAK ALTI PROFİLİ       | ⑨ — 1063 - GİZLİ KANAT PROFİLİ   |
| ④ — 1052 - 20' LİK KAPAK PROFİLİ    | ⑩ — MK-18 - CAM CEPHE DIŞ FİTİLİ |
| ⑤ — MK-16 - CEPHE KAPAK FİTİLİ      | ⑪ — 517 - TİJ PROFİLİ            |
| ⑥ — 1024 - GİZLİ KANAT KASA PROFİLİ |                                  |

# MK CEPHE 50

## MK FACADE 50

### KAPAKLI DETAYLARI

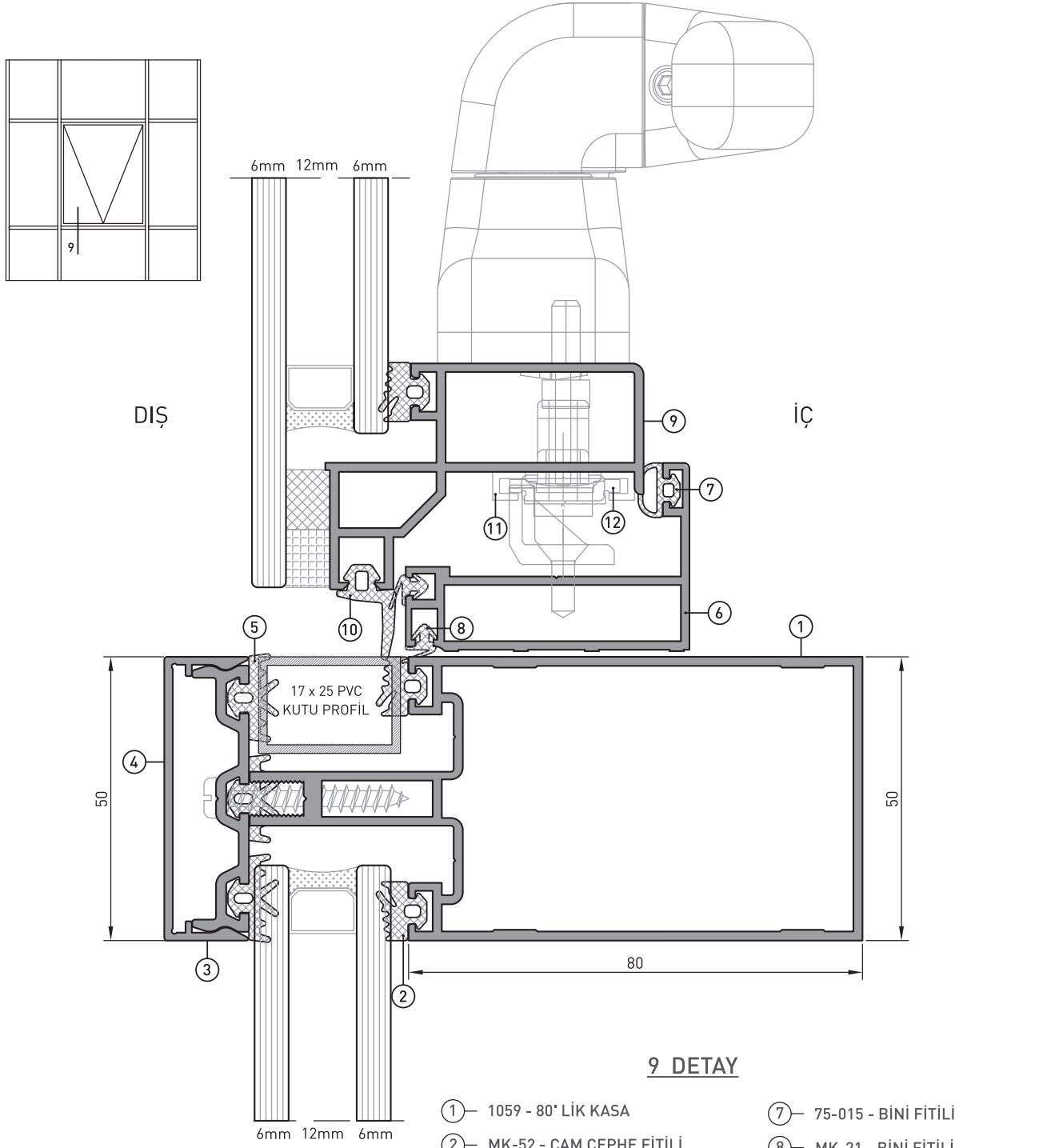

# MK CEPHE 50

## MK FACADE 50

### KAPAKLI DETAYLARI

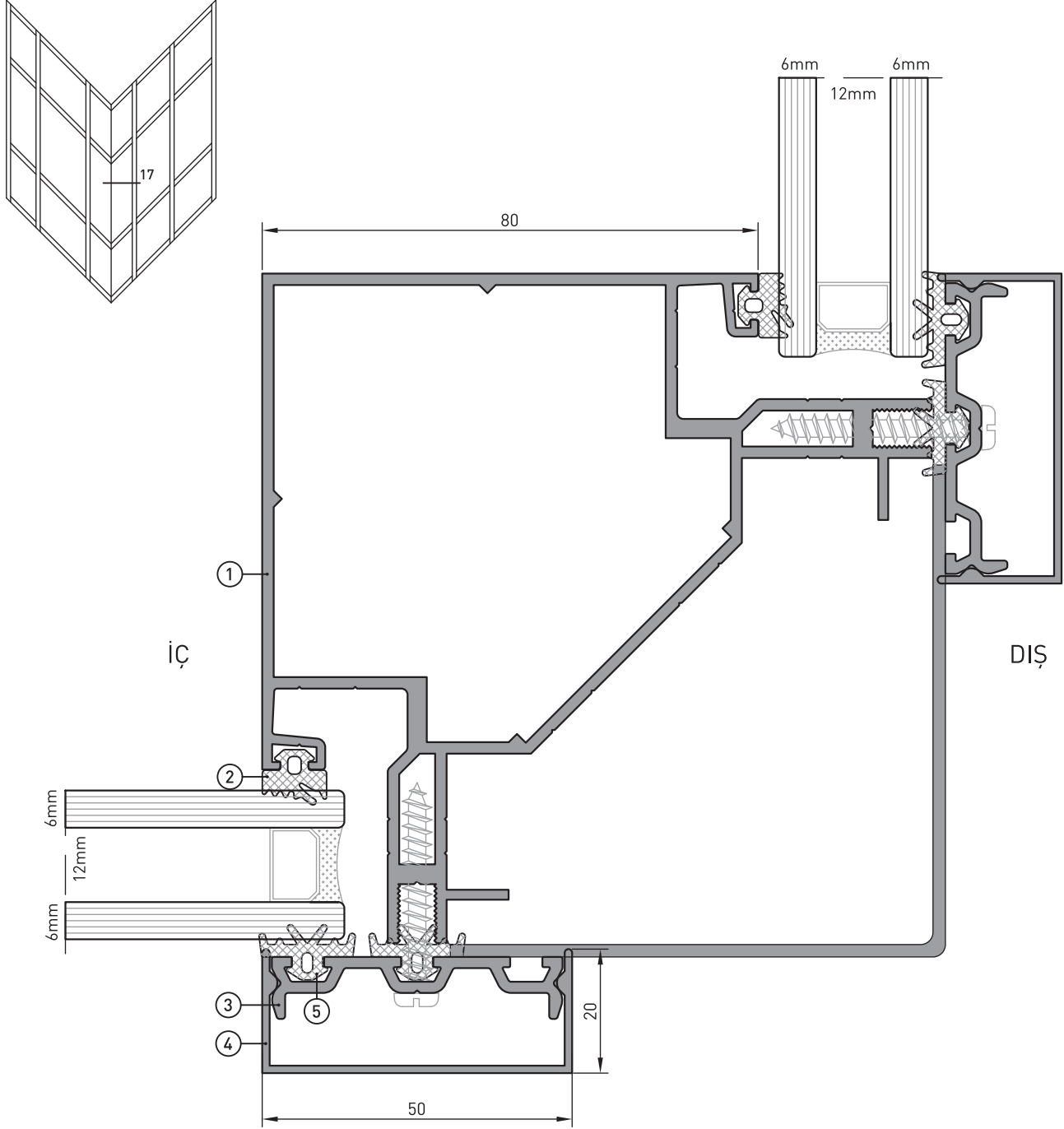

#### 17 DETAY

- ① 1080 - 90° KÖŞE DÖNÜŞ PROFİLİ
- ② MK-52 - CAM CEPHE FİTİLİ
- ③ 1099 - KAPAK ALTI PROFİLİ
- ④ 1052 - 20' LİK KAPAK PROFİLİ
- ⑤ MK-16 - CEPHE KAPAK FİTİLİ





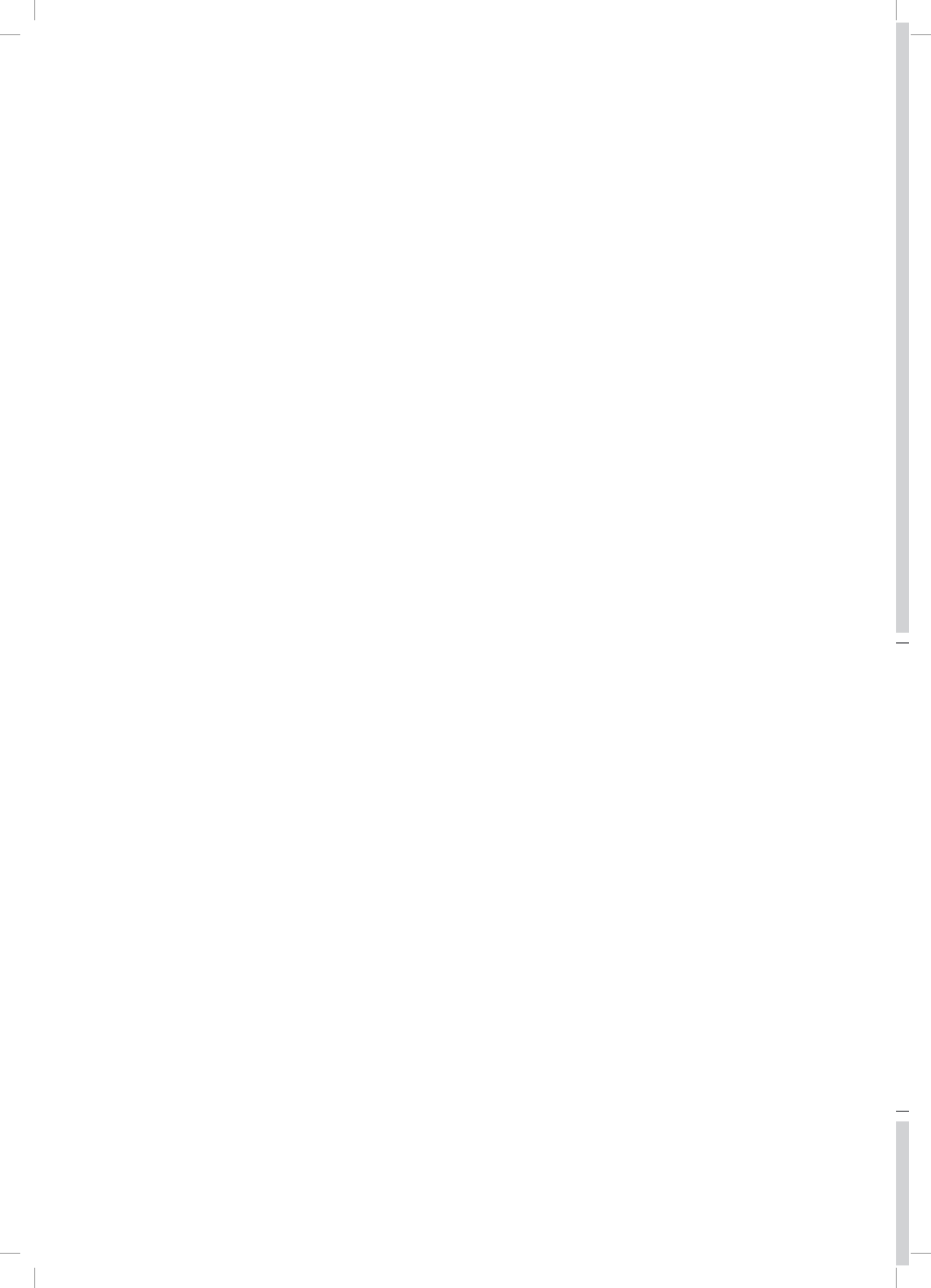

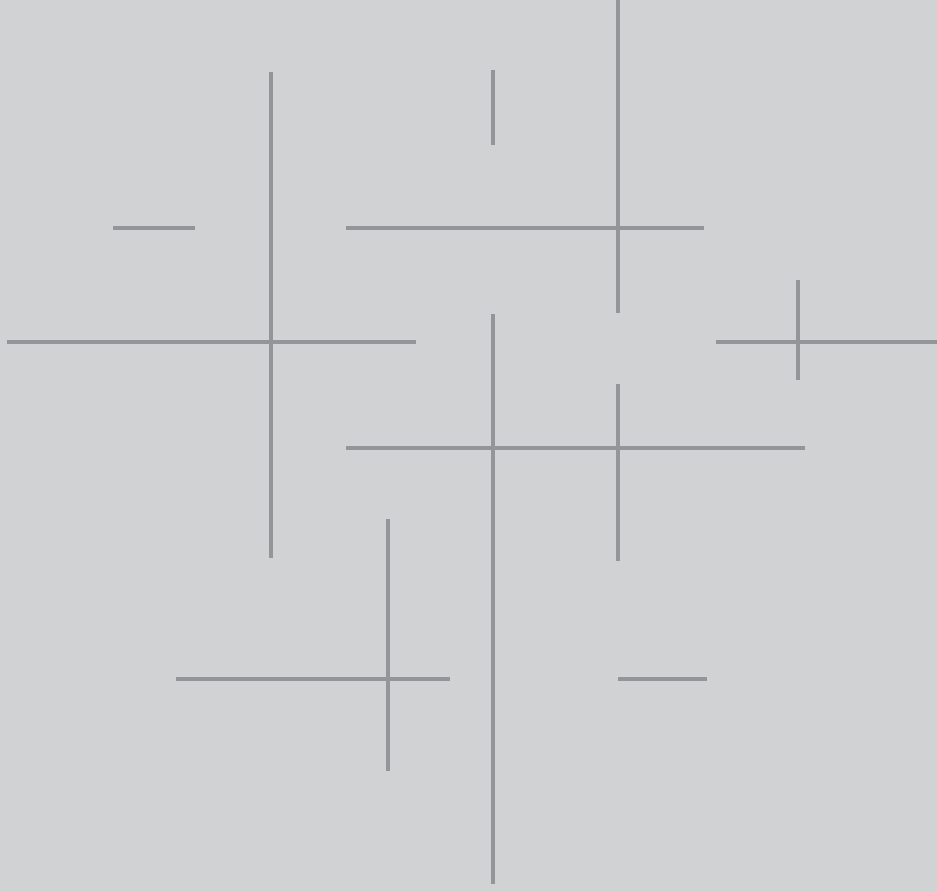

## **MK CEPHE 50**

MK FACADE 50

**91-94**

**SİLİKON DETAYLAR**

SILICONE DETAILS

# MK CEPHE 50

## MK FACADE 50

### SİLİKON DETAYLAR

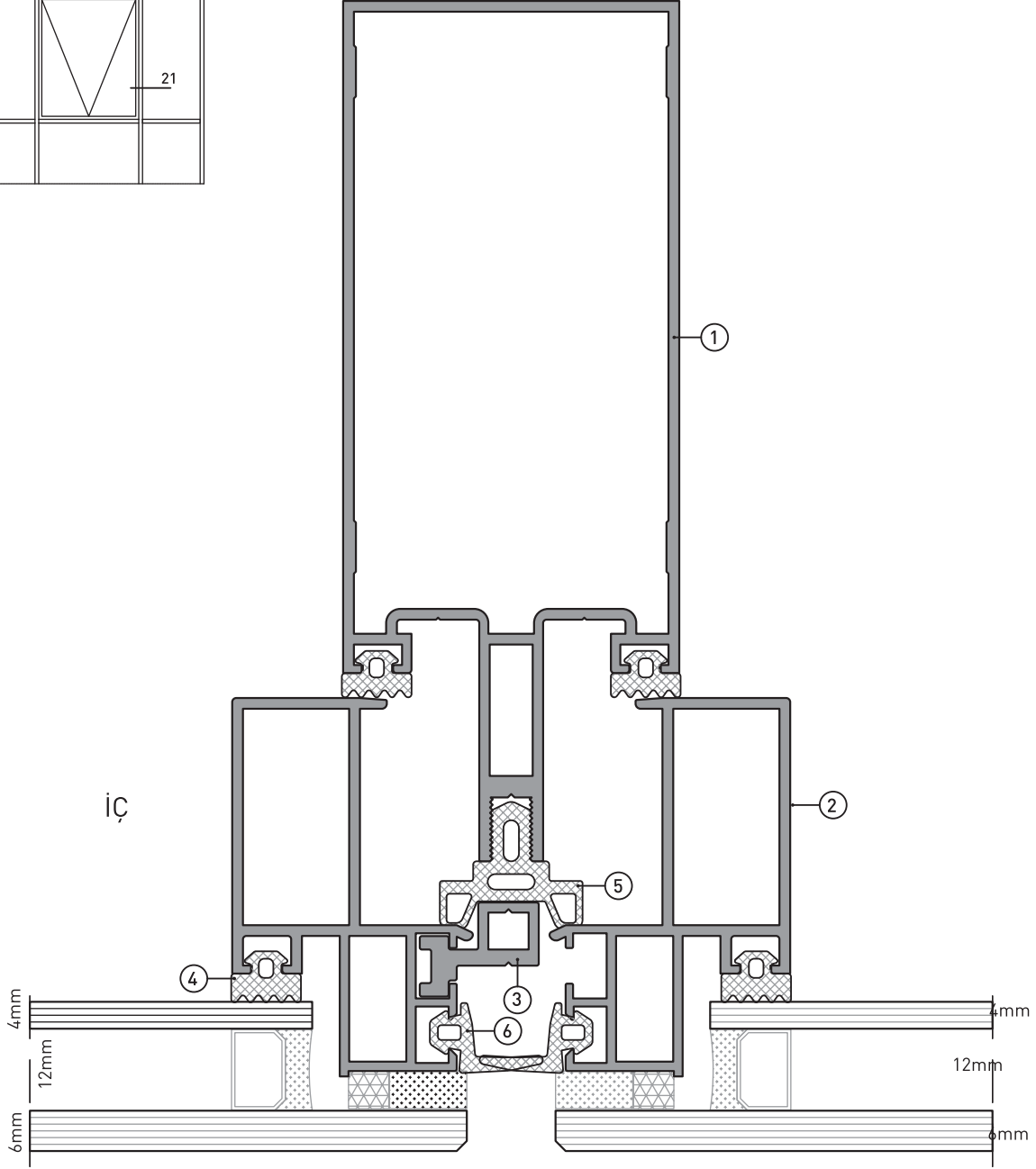
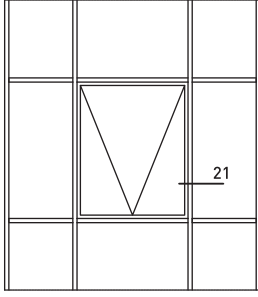

#### 21 DETAY

- ① - 1018 - 100'LÜK KASA
- ② - 1019 - GİZLİ KANAT PROFİLİ
- ③ - 1029 - ÇERÇEVE BAĞLANTI
- ④ - MK - 37 CAM CEPHE FİTİLİ
- ⑤ - MK - 19 CAM CEPHE ORTA FİTİLİ
- ⑥ - MK - 18 CAM CEPHE DIŞ FİTİLİ

# MK CEPHE 50

## MK FACADE 50

### SİLİKON DETAYLAR

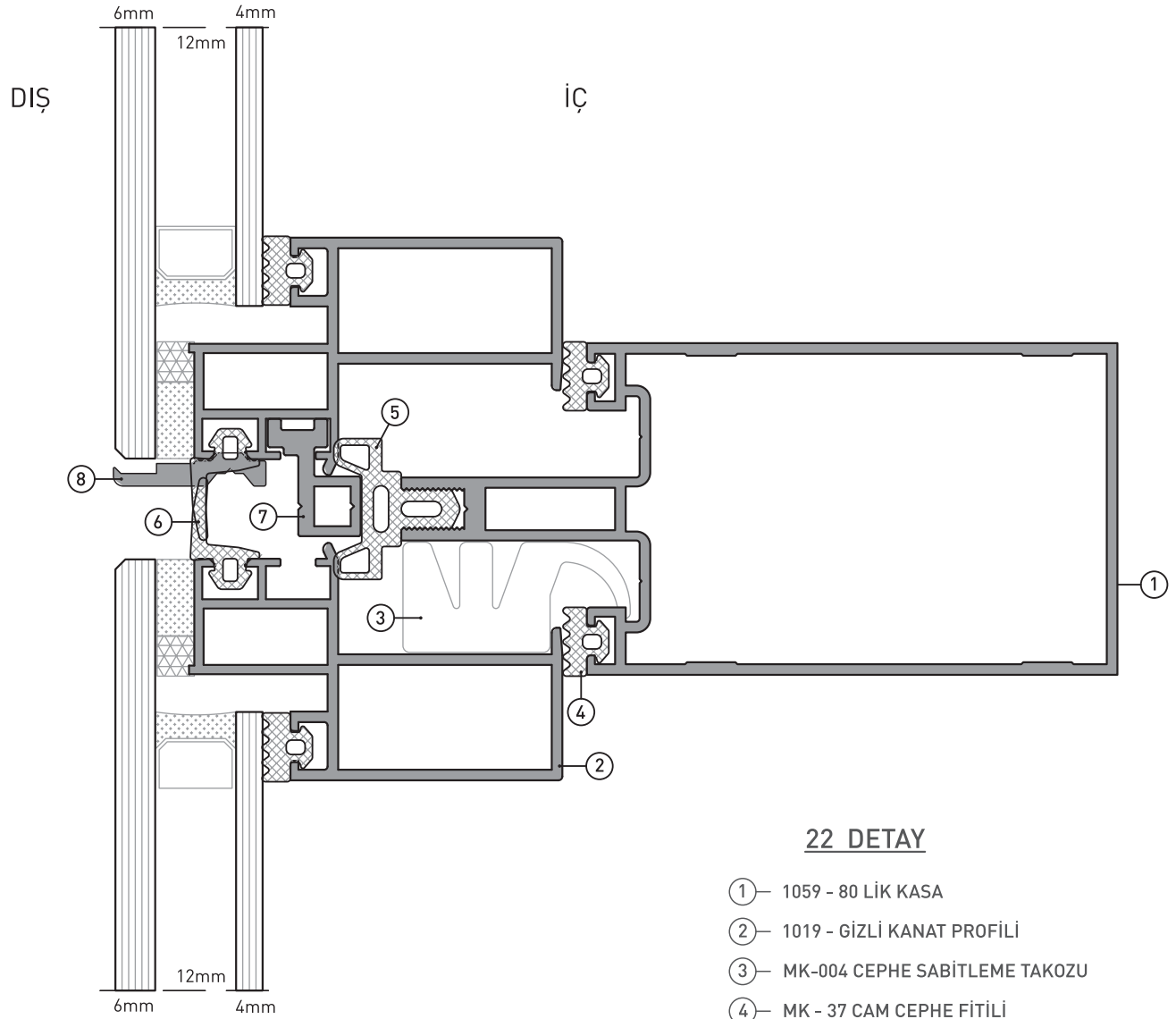
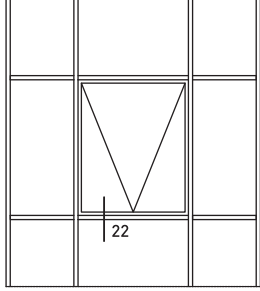

#### 22 DETAY

- ① - 1059 - 80 LİK KASA
- ② - 1019 - GİZLİ KANAT PROFİLİ
- ③ - MK-004 CEPHE SABİTLEME TAKOZU
- ④ - MK - 37 CAM CEPHE FİTİLİ
- ⑤ - MK - 19 CAM CEPHE ORTA FİTİLİ
- ⑥ - MK - 18 CAM CEPHE DIŞ FİTİLİ
- ⑦ - 1029 - ÇERÇEVE BAĞLANTI
- ⑧ - 1085 -CAM TUTUCU PROFİL

# MK CEPHE 50

## MK FACADE 50

### SİLİKON DETAYLAR

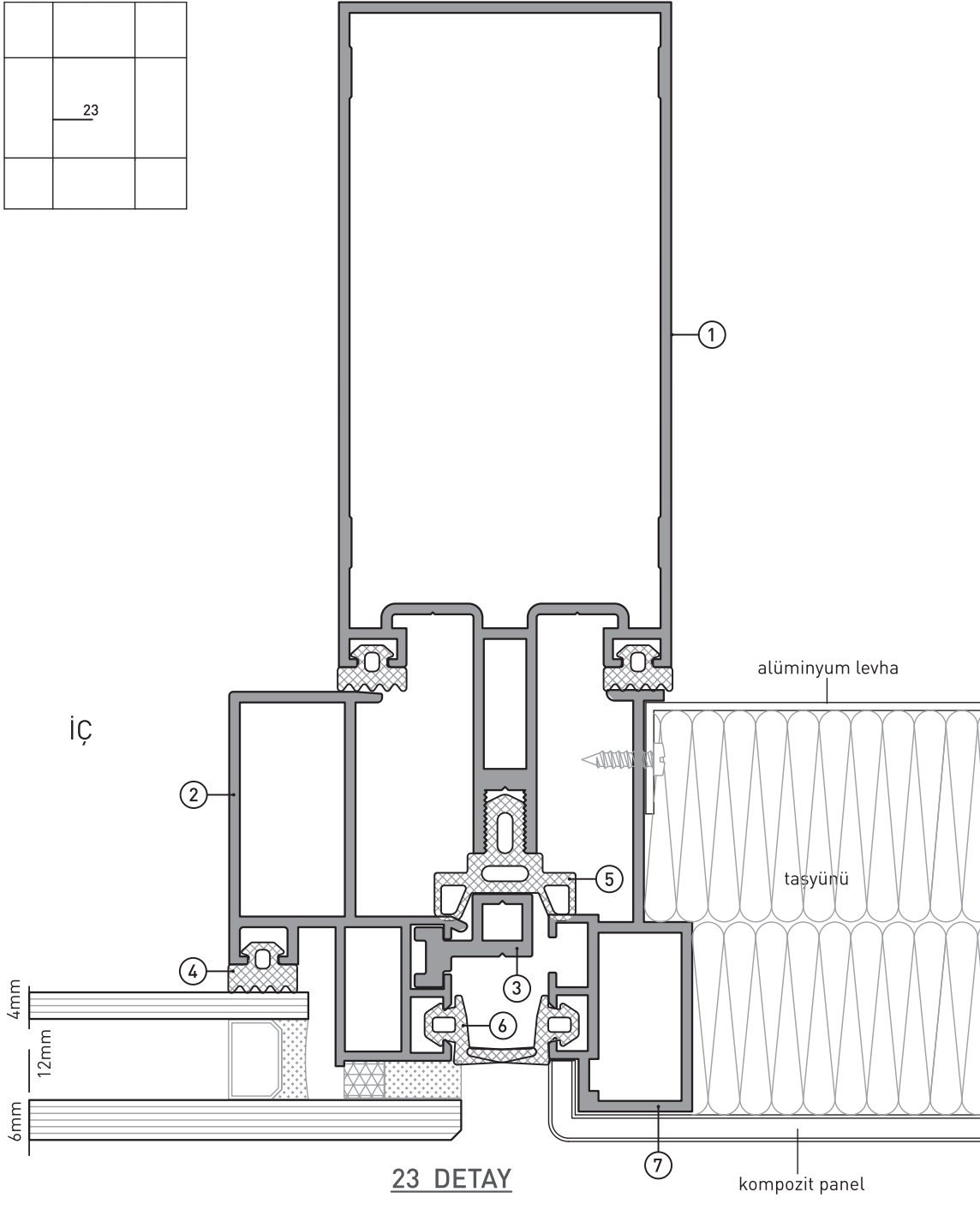
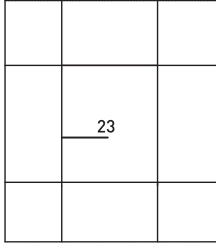

DIŞ

- ① - 1018 - 100'LÜK KASA
- ② - 1019 - GİZLİ KANAT PROFİLİ
- ③ - 1029 - ÇERÇEVE BAĞLANTI
- ④ - MK - 37 CAM CEPHE FİTİLİ
- ⑤ - MK - 19 CAM CEPHE ORTA FİTİLİ
- ⑥ - MK - 18 CAM CEPHE DIŞ FİTİLİ
- ⑦ - 1083 - KOMPOZİT ÇERÇEVE PROFİLİ

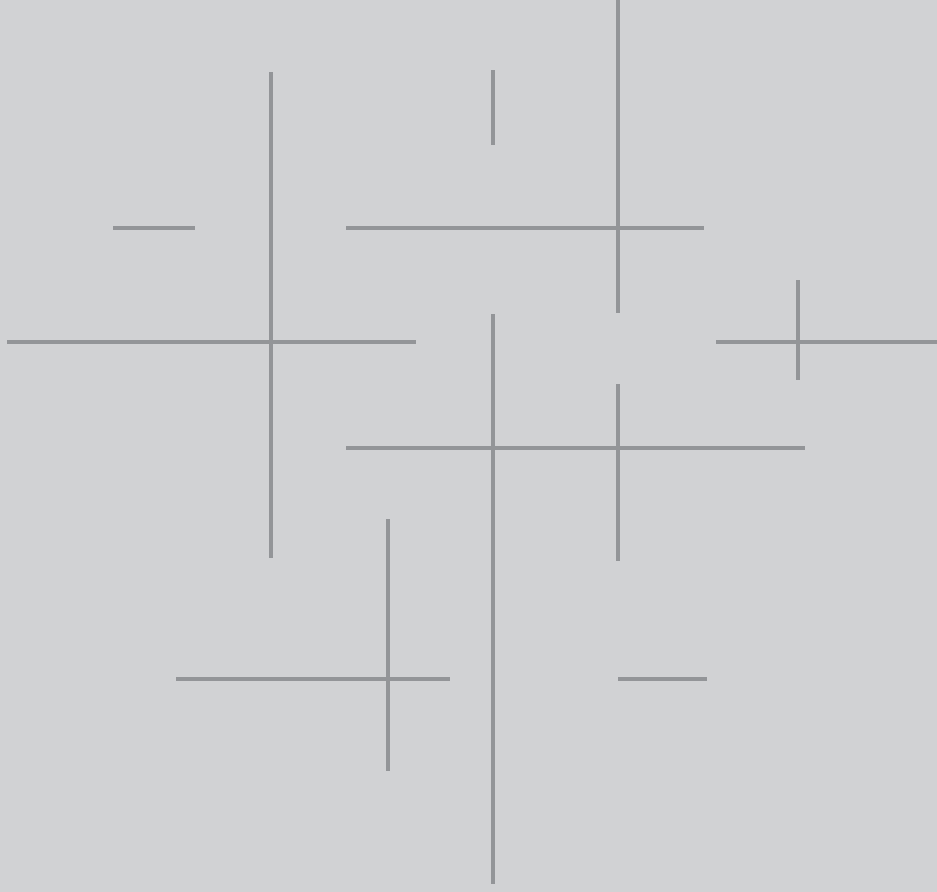

**MK CEPHE 65 ÇELİK TAKVİYELİ CEPHE SİSTEMİ**  
FACADE SYSTEM WITH STEEL REINFORCEMENT

**95-114**  
PROFİL KESİT DETAYLARI  
PROFILE DETAILS DRAWINGS

MK CEPHE 65 ÇELİK TAKVİYELİ CEPHE SİSTEMİ  
FACADE SYSTEM WITH STEEL REINFORCEMENT

PROFİL KESİT DETAYLARI

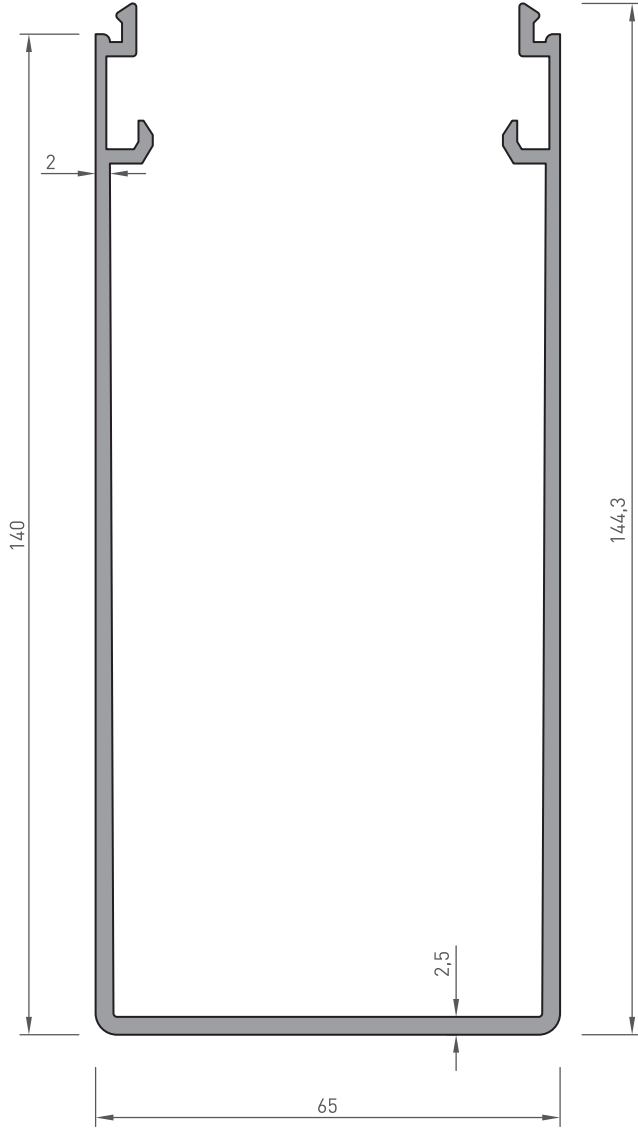

**1000-123**  
140 LİK KASA  
2.240 kg/m

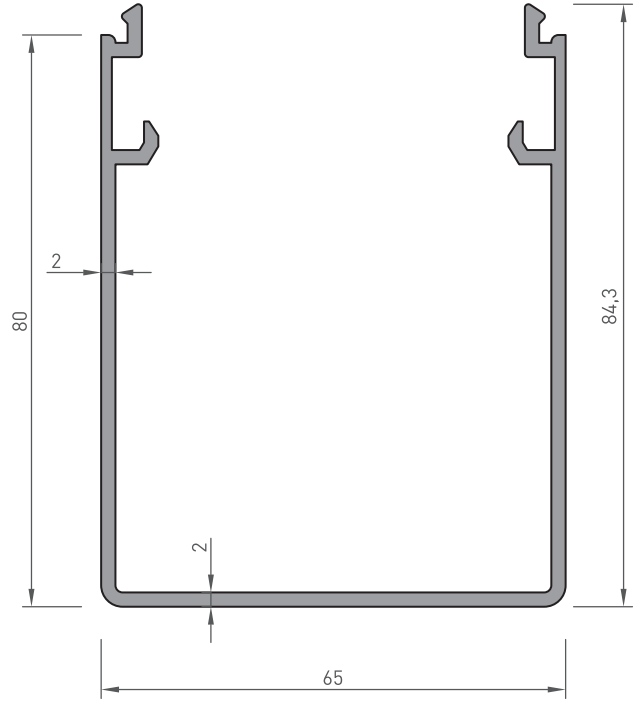

**1000-124**  
80 LİK KASA  
1.345 kg/m



# MK CEPHE 65 ÇELİK TAKVİYELİ CEPHE SİSTEMİ FACADE SYSTEM WITH STEEL REINFORCEMENT

## PROFİL KESİT DETAYLARI

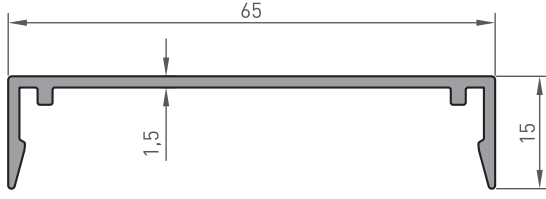

**1000-125**  
15 LİK KAPAK  
0.405 kg/m

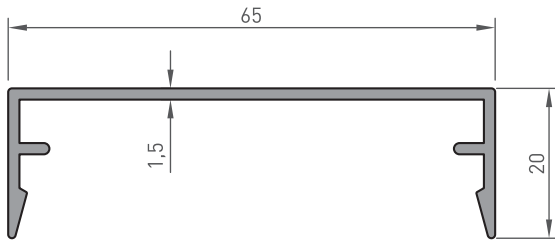

**1000-126**  
20 LİK KAPAK  
0.455 kg/m

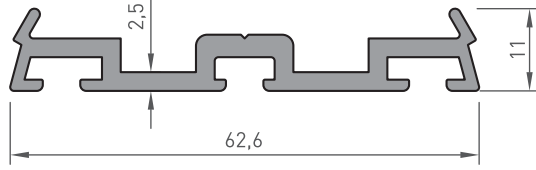

**1000-127**  
KAPAK ALTI  
0.675 kg/m

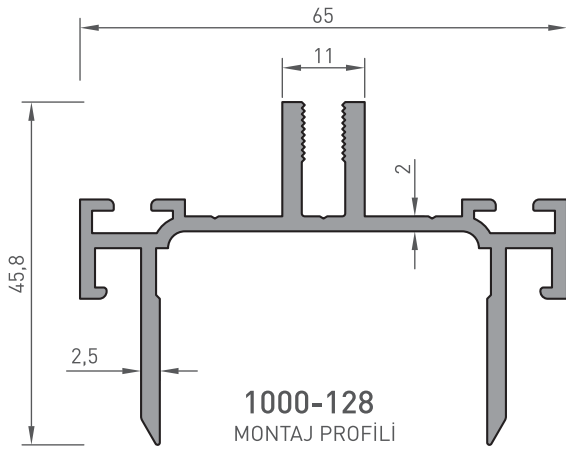

**1000-128**  
MONTAJ PROFİLİ  
1.095 kg/m

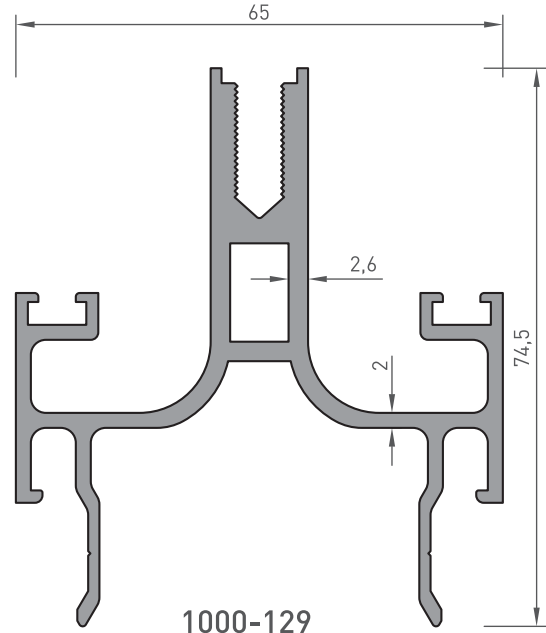

**1000-129**  
DÜŞEY TAŞIYICI  
MONTAJ PROFİLİ  
1.855 kg/m

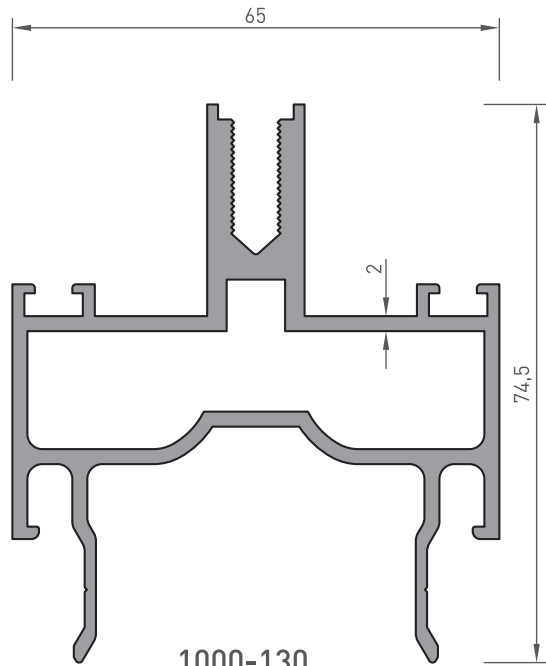



**1000-130**  
YATAY TAŞIYICI  
MONTAJ PROFİLİ  
1.900 kg/m

\*BELİRTİLEN AĞIRLIKLAR, TEORİK PRES ÇIKIŞ AĞIRLIKLARIDIR.  
\*BOYALI PROFİLLERDE AĞIRLIĞA %5 İLAVE EDİLMESİ GEREKLİDİR.

# MK CEPHE 65 ÇELİK TAKVİYELİ CEPHE SİSTEMİ FACADE SYSTEM WITH STEEL REINFORCEMENT

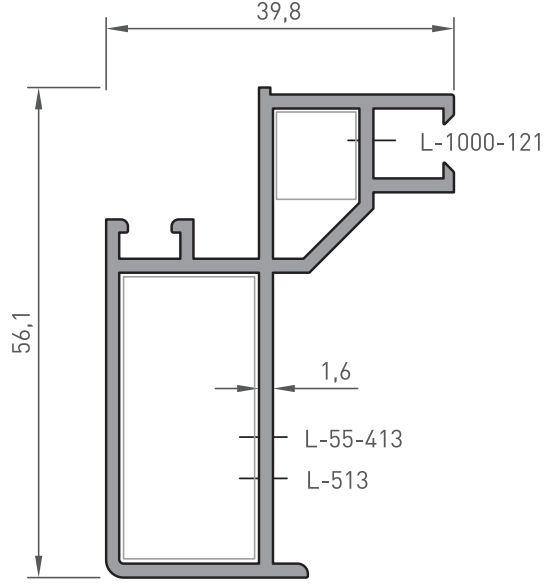
## PROFİL KESİT DETAYLARI

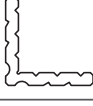

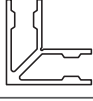
Profil Kodu	1063	
Tanım:	Cam Kaset	
Ağırlık:	0.830 kg/m	
Jy:	2.35 cm <sup>4</sup>	
Jx:	11.26 cm <sup>4</sup>	
Köşe Takozu:	 1000-121	Kesim Ölçüsü 10.4mm
Köşe Takozu:	 55-413	Kesim Ölçüsü 32.8mm
Köşe Bağlantı:	 513	

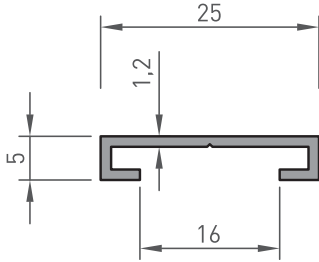

Profil Kodu	516
Tanım:	Tij Çubuğu-Dış
Ağırlık:	0.130 kg/m

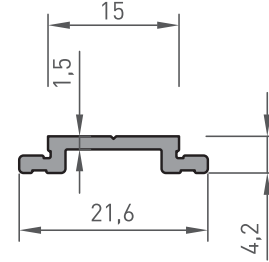

Profil Kodu	517
Tanım:	Tij Çubuğu-İç
Ağırlık:	0.130 kg/m

# MK CEPHE 65 ÇELİK TAKVİYELİ CEPHE SİSTEMİ FACADE SYSTEM WITH STEEL REINFORCEMENT

## PROFİL KESİT DETAYLARI

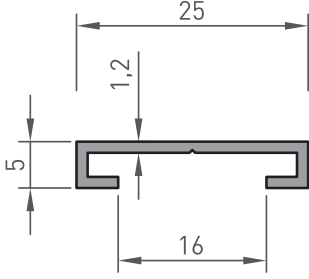

Profil Kodu	516
Tanım:	Tij Çubuğu-Dış
Ağırlık:	0.130 kg/m

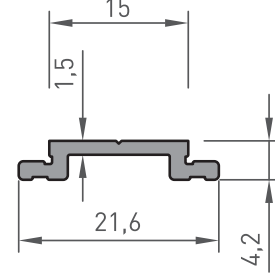

Profil Kodu	517
Tanım:	Tij Çubuğu-İç
Ağırlık:	0.130 kg/m

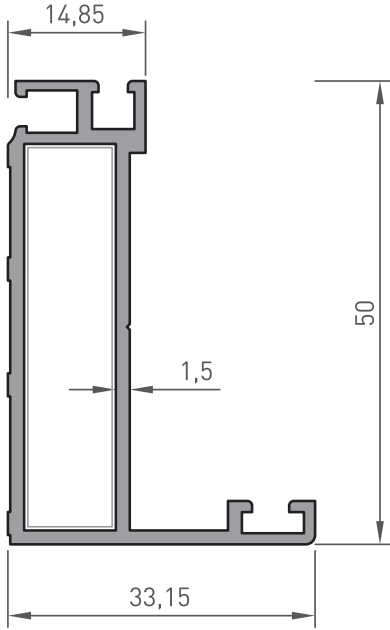

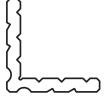
Profil Kodu	1024
Tanım:	Gizli Kanat Kasası
Ağırlık:	0.635 kg/m
Jy:	1.41 cm <sup>4</sup>
Jx:	7.37 cm <sup>4</sup>
Köşe Takozu:	 1000-121 Kesim Ölçüsü 41.2 mm

\*BELİRTİLEN AĞIRLIKLAR, TEORİK PRES ÇIKIŞ AĞIRLIKLARIDIR.  
\*BOYALI PROFİLLERDE AĞIRLIĞA %5 İLAVE EDİLMESİ GEREKLİDİR.

# MK CEPHE 65 ÇELİK TAKVİYELİ CEPHE SİSTEMİ FACADE SYSTEM WITH STEEL REINFORCEMENT

## PROFİL KESİT DETAYLARI

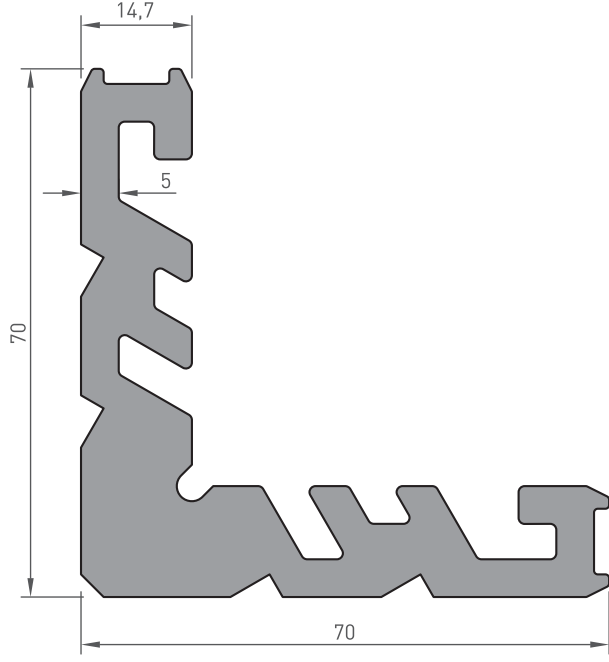

Profil Kodu	55-413
Tanım:	Köşe Takozu
Ağırlık:	3.720 kg/m

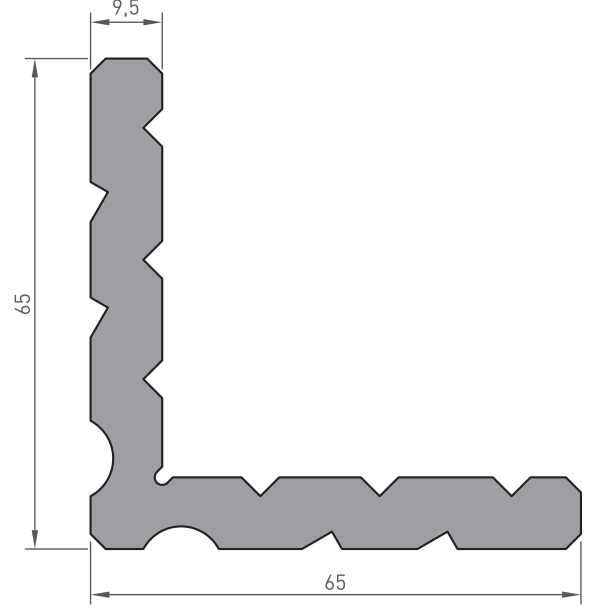

Profil Kodu	1000-121
Tanım:	Köşe Takozu
Ağırlık:	2.785 kg/m

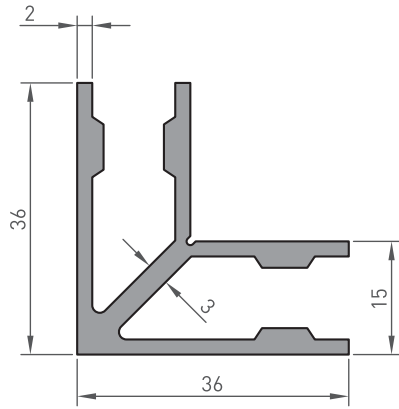

Profil Kodu	513
Tanım:	Dar Çavuş Köşe
Ağırlık:	0.865 kg/m

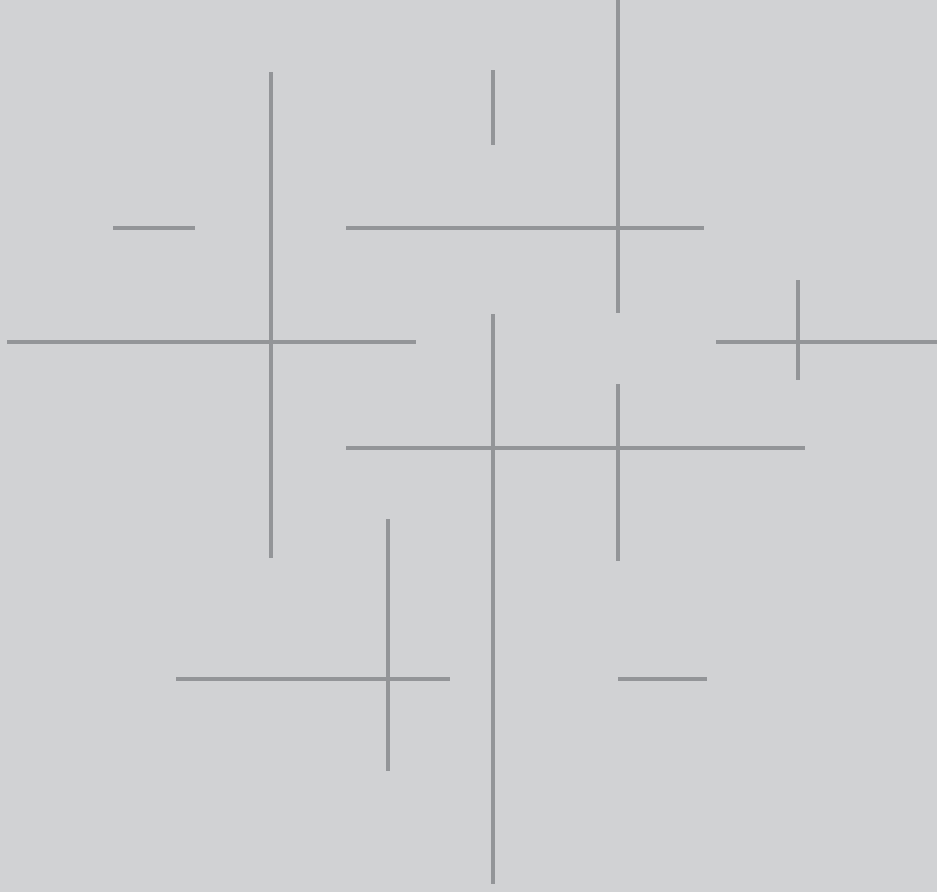

**MK CEPHE 65 ÇELİK TAKVİYELİ CEPHE SİSTEMİ**  
FACADE SYSTEM WITH STEEL REINFORCEMENT

**101-104**  
**SİSTEM DETAYLARI**  
SYSTEM DETAILS

# MK CEPHE 65 ÇELİK TAKVİYELİ CEPHE SİSTEMİ FACADE SYSTEM WITH STEEL REINFORCEMENT

## SİSTEM DETAYLARI

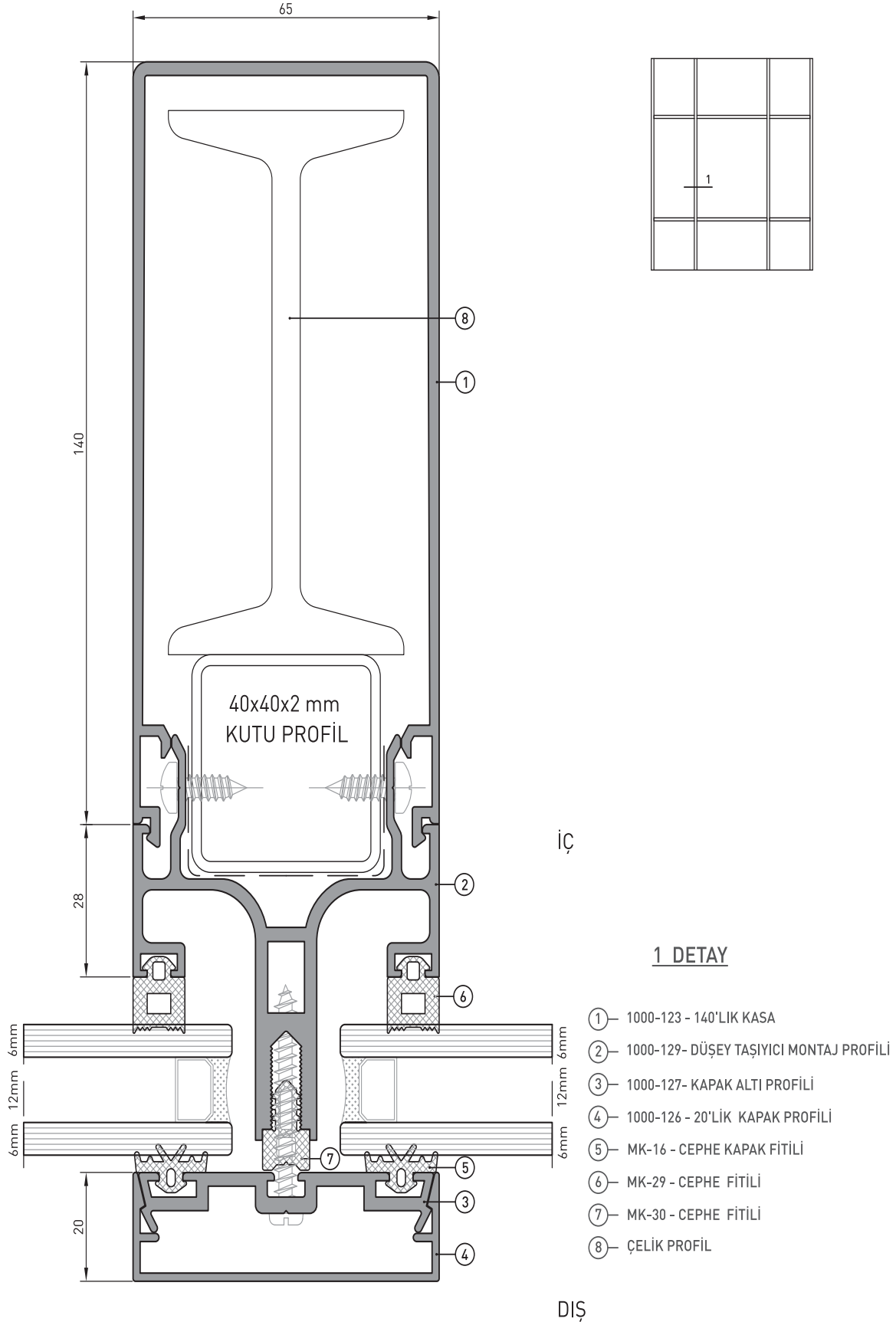

# MK CEPHE 65 ÇELİK TAKVİYELİ CEPHE SİSTEMİ FACADE SYSTEM WITH STEEL REINFORCEMENT

## SİSTEM DETAYLARI

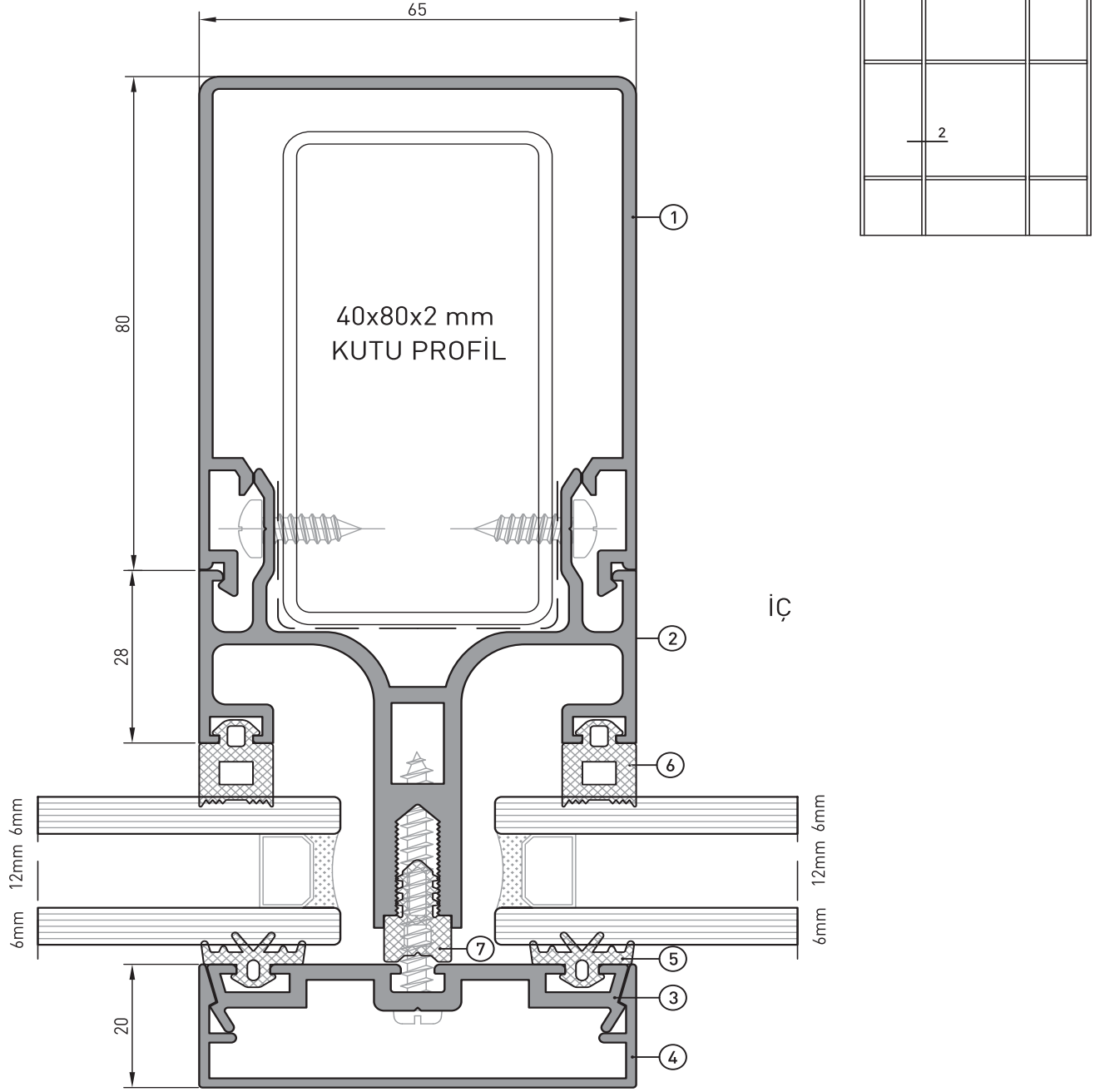

### 2 DETAY

- ① - 1000-124 - 80' LİK KASA
- ② - 1000-129- DÜŞEY TAŞIYICI MONTAJ PROFİLİ
- ③ - 1000-127- KAPAK ALTI PROFİLİ
- ④ - 1000-126 - 20' LİK KAPAK PROFİLİ
- ⑤ - MK-16 - CEPHE KAPAK FİTİLİ
- ⑥ - MK-29 - CEPHE FİTİLİ
- ⑦ - MK-30 - CEPHE FİTİLİ

DIŞ

# MK CEPHE 65 ÇELİK TAKVİYELİ CEPHE SİSTEMİ FACADE SYSTEM WITH STEEL REINFORCEMENT

## SİSTEM DETAYLARI

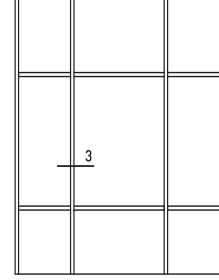
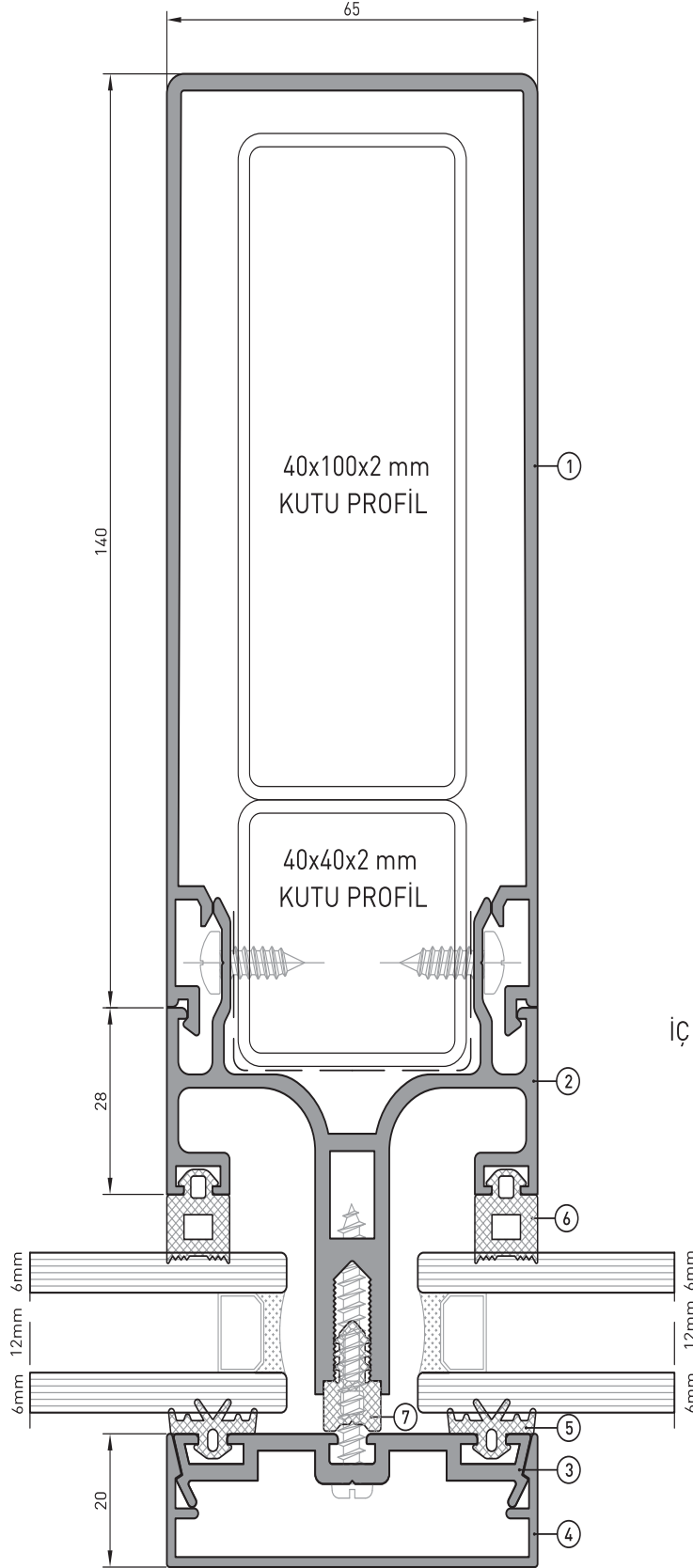

### 3 DETAY

- ① 1000-123 - 140' LİK KASA
- ② 1000-129- DÜŞEY TAŞIYICI MONTAJ PROFİLİ
- ③ 1000-127- KAPAK ALTI PROFİLİ
- ④ 1000-126 - 20' LİK KAPAK PROFİLİ
- ⑤ MK-16 - CEPHE KAPAK FİTİLİ
- ⑥ MK-29 - CEPHE FİTİLİ
- ⑦ MK-30 - CEPHE FİTİLİ



# MK CEPHE 65 ÇELİK TAKVİYELİ CEPHE SİSTEMİ FACADE SYSTEM WITH STEEL REINFORCEMENT

## SİSTEM DETAYLARI

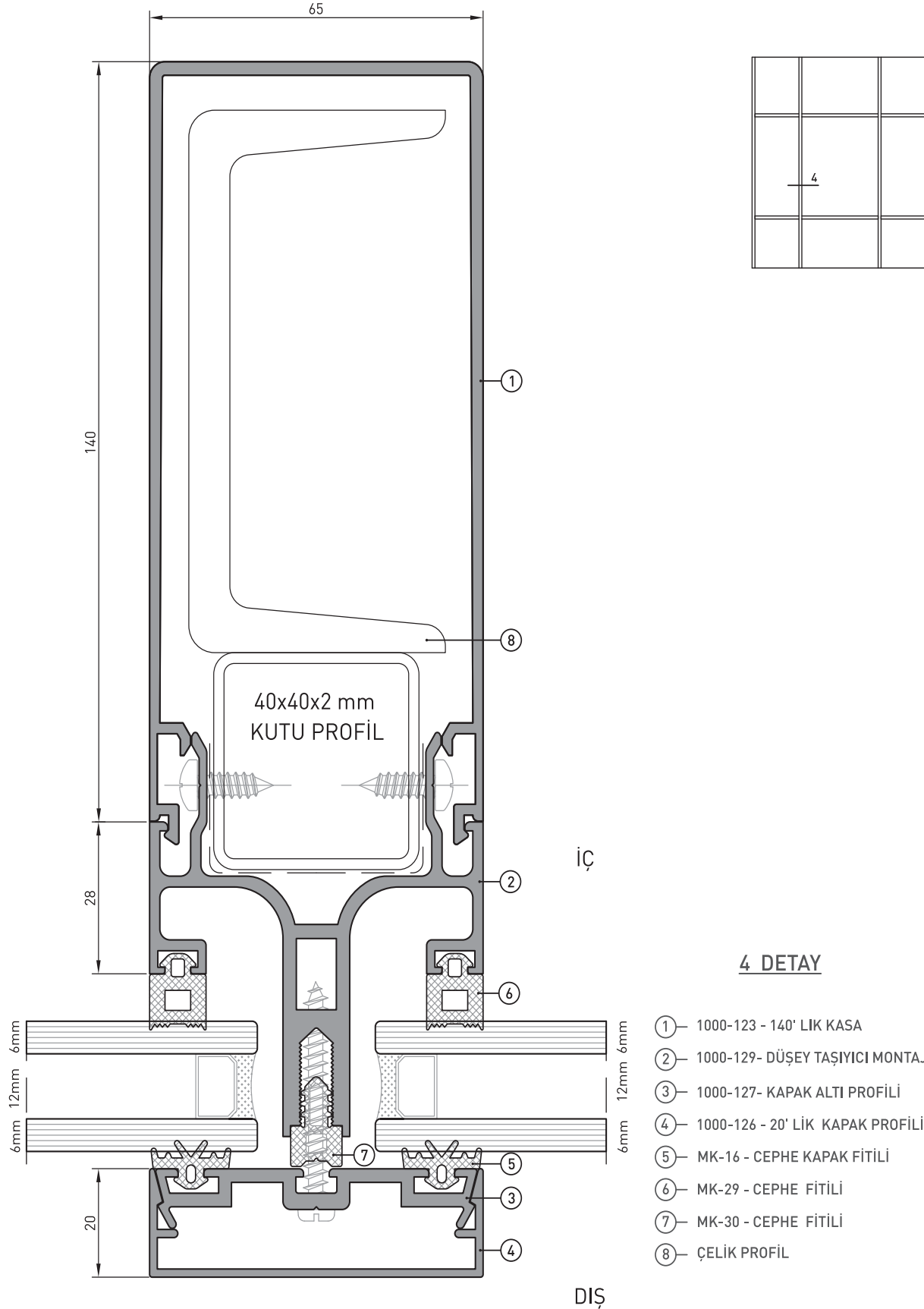

# MK CEPHE 65 ÇELİK TAKVİYELİ CEPHE SİSTEMİ FACADE SYSTEM WITH STEEL REINFORCEMENT

## SİSTEM DETAYLARI

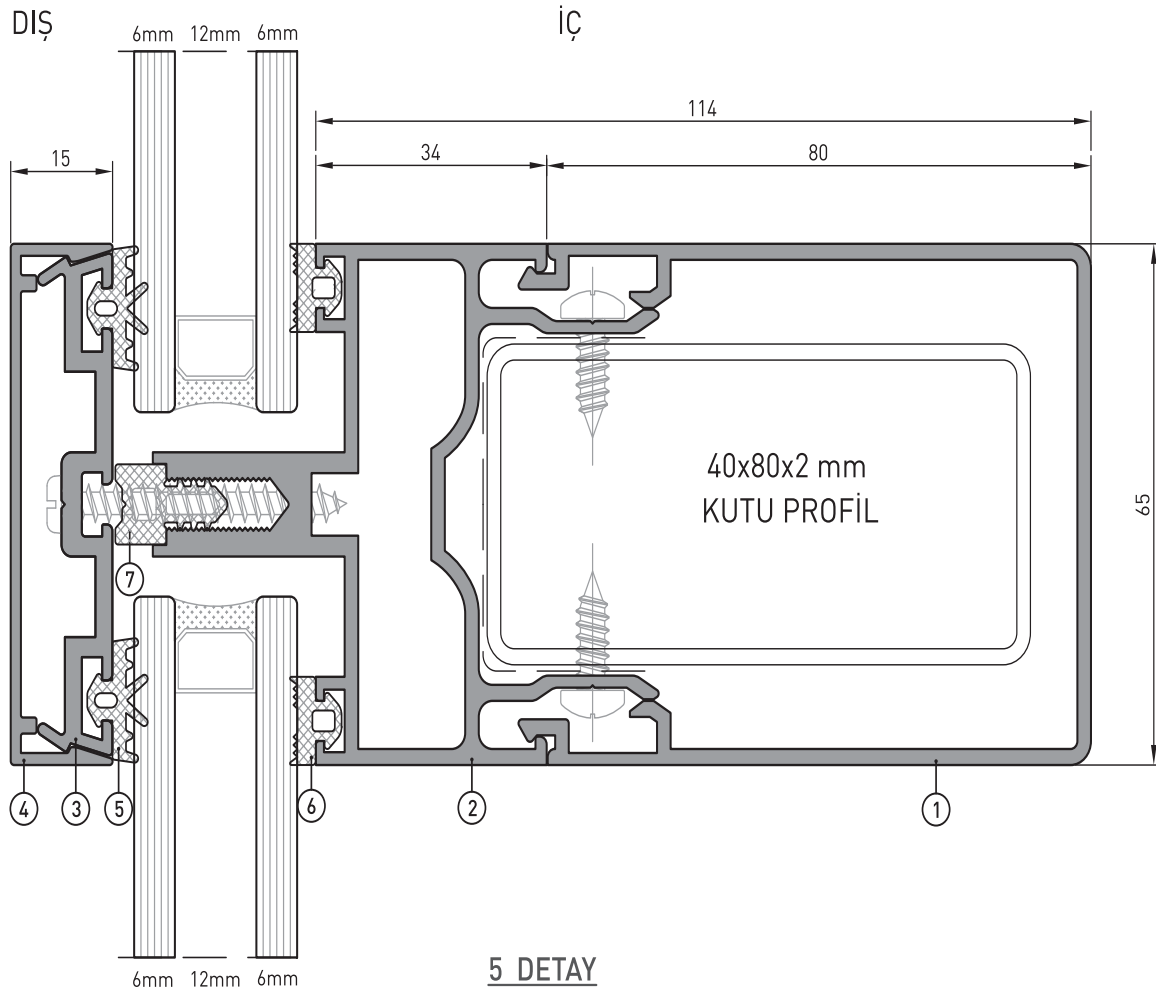
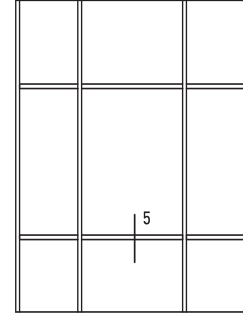

### 5 DETAY

- ① - 1000-124 - 80' LİK KASA
- ② - 1000-130- YATAY TAŞIYICI MONTAJ PROFİLİ
- ③ - 1000-127- KAPAK ALTI PROFİLİ
- ④ - 1000-125 - 15' LİK KAPAK PROFİLİ
- ⑤ - MK-16 - CEPHE KAPAK FİTİLİ
- ⑥ - MK-28 - CEPHE FİTİLİ
- ⑦ - MK-30 - CEPHE FİTİLİ

# MK CEPHE 65 ÇELİK TAKVİYELİ CEPHE SİSTEMİ FACADE SYSTEM WITH STEEL REINFORCEMENT

## SİSTEM DETAYLARI

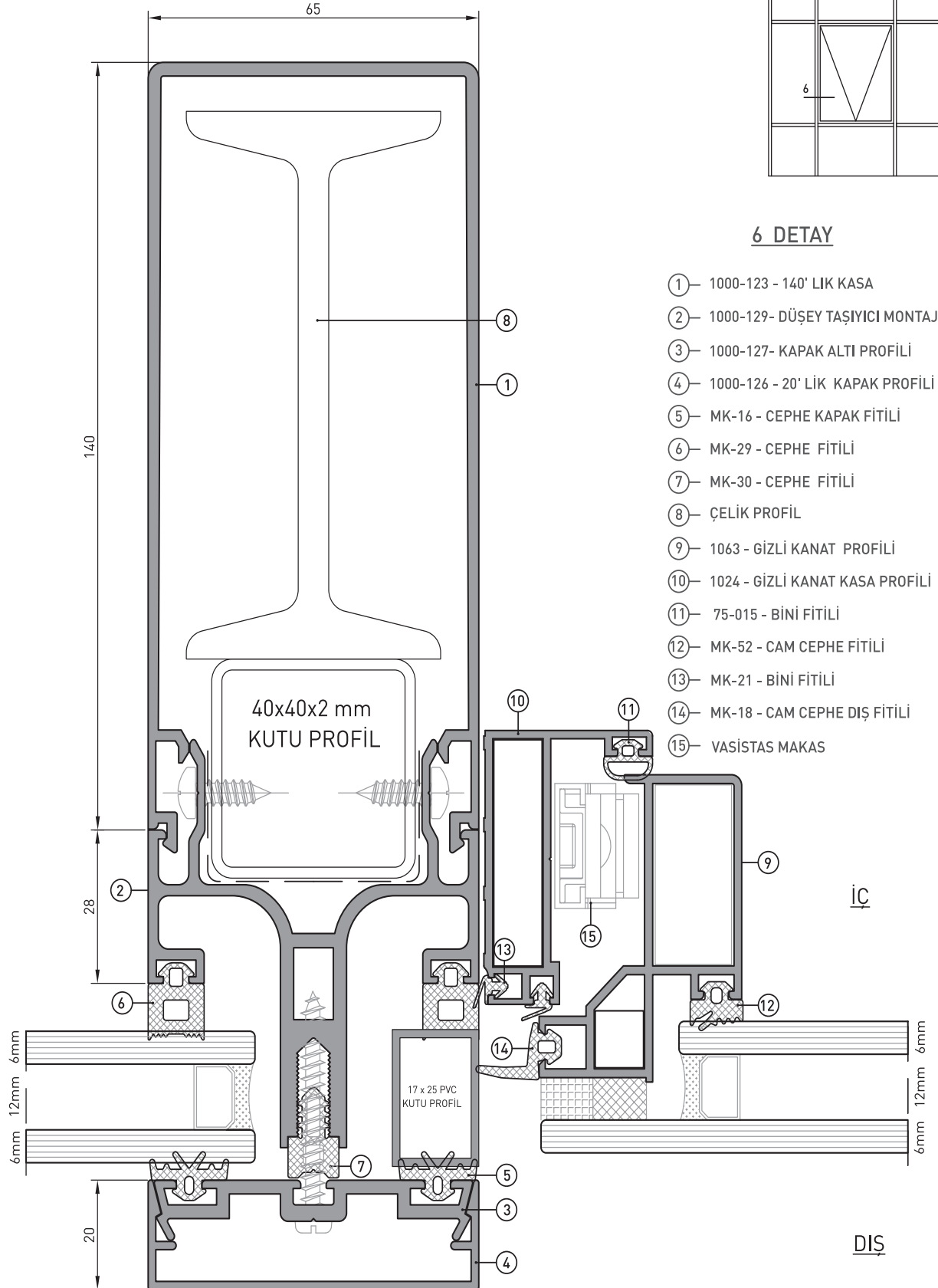

# MK CEPHE 65 ÇELİK TAKVİYELİ CEPHE SİSTEMİ FACADE SYSTEM WITH STEEL REINFORCEMENT

## SİSTEM DETAYLARI

### 7 DETAY

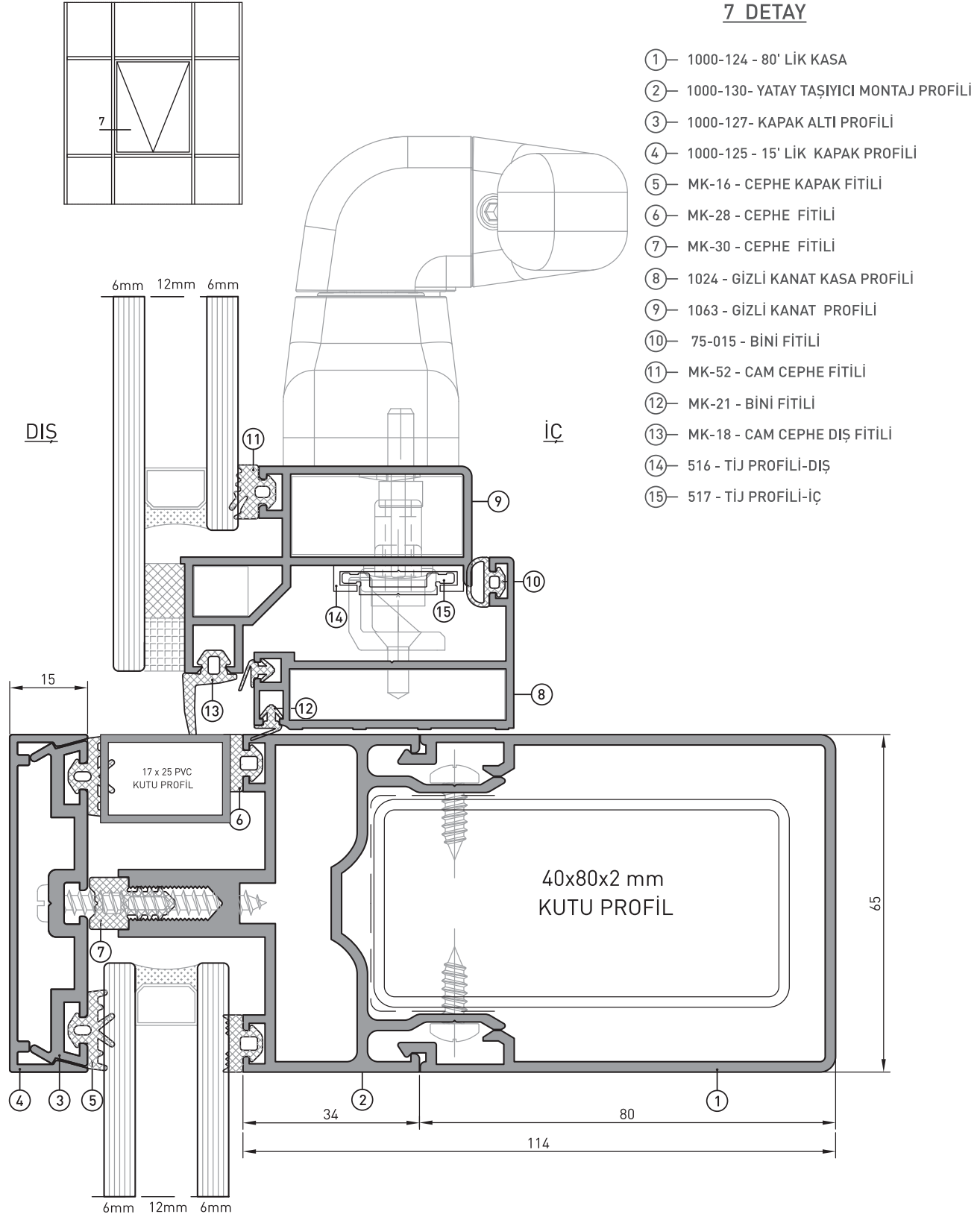

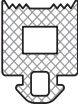

# MK CEPHE 65 ÇELİK TAKVİYELİ CEPHE SİSTEMİ FACADE SYSTEM WITH STEEL REINFORCEMENT

## FİTİLLER / GASKETS

AKSESUAR ACCESSORY	SİPARİŞ KODU ORDER CODE	PAKET ADET UNITS	AKSESUAR ACCESSORY	SİPARİŞ KODU ORDER CODE	PAKET ADET UNITS
 CEPHE KAPAK FİTİLİ	<b>MK-16</b>	<b>165 m</b> 75 gr/m	 CAM CEPHE FİTİLİ	<b>MK-52</b>	<b>200 m</b> 60 gr/m
 CAM CEPHE FİTİLİ	<b>MK-17</b>	<b>220 m</b> 60 gr/m	 CEPHE FİTİLİ	<b>MK-28</b>	<b>205 m</b> 59 gr/m
 CAM CEPHE FİTİLİ	<b>MK-37</b>	<b>190 m</b> 65 gr/m	 CEPHE FİTİLİ	<b>MK-29</b>	<b>80 m</b> 127 gr/m
 CAM CEPHE FİTİLİ	<b>MK-40</b>	<b>125 m</b> 95 gr/m	 CAM CEPHE FİTİLİ	<b>MK-30</b>	<b>125 m</b> 98 gr/m
 KULAKLI FİTİL	<b>MK-32</b>	<b>185 m</b> 65 gr/m	 CAM CEPHE DIŞ FİTİLİ	<b>MK-18</b>	<b>170 m</b> 70 gr/m



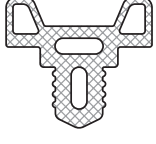

MK CEPHE 65 ÇELİK TAKVİYELİ CEPHE SİSTEMİ  
FACADE SYSTEM WITH STEEL REINFORCEMENT

FİTİLLER / GASKETS

AKSESUAR ACCESSORY	SİPARİŞ KODU ORDER CODE	PAKET ADET UNITS	AKSESUAR ACCESSORY	SİPARİŞ KODU ORDER CODE	PAKET ADET UNITS
 CEPHE ORTA FİTİLİ	<b>MK-19</b>	<b>60 m</b> 175 gr/m			
 BİNİ FİTİLİ	<b>MK-21</b>	<b>450 m</b> 30 gr/m			
 BİNİ FİTİLİ	<b>75-015</b>	<b>240 m</b> 40 gr/m			

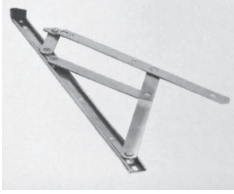

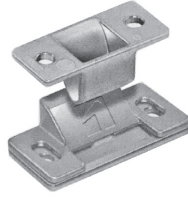
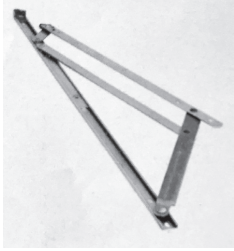

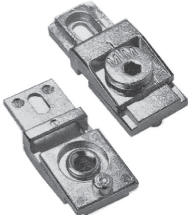

# MK CEPHE 65 ÇELİK TAKVİYELİ CEPHE SİSTEMİ FACADE SYSTEM WITH STEEL REINFORCEMENT

## AKSESUARLAR / ACCESSORIES

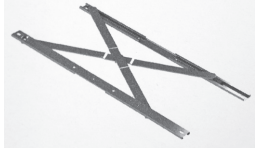
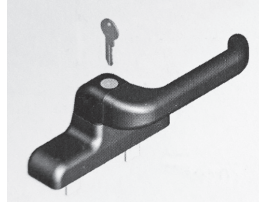
AKSESUAR ACCESSORY	SİPARİŞ KODU ORDER CODE	PAKET ADET UNITS	AKSESUAR ACCESSORY	SİPARİŞ KODU ORDER CODE	PAKET ADET UNITS
 TERS VASİSTAS MAKAS	MK STORMB10		 KOL ADAPTÖRÜ	MK STL1406	
	MK STORMB12			MK STL1410	
	MK STORMB16			MK STL1506	
	MK STORMB22			MK STL1510	
	MK STORMB26			MK STL1606	
 PARALEL MAKAS	MK PARALEL PLUS		 KASET ÜST BASKI APARATI	MK S8305	
				MK R8304	
 TERS VASİSTAS MAKAS	MK STERLING		 KOL	MK VIRAGE WINDOW HANDLES	
 90° AÇILIM MAKAS	MK STORMBS10		 MAKAS AYAR KLİPSİ	MK S7280	
	MK STORMBS16				

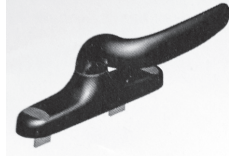
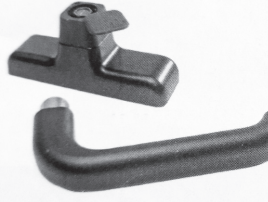
MK CEPHE 65 ÇELİK TAKVİYELİ CEPHE SİSTEMİ  
FACADE SYSTEM WITH STEEL REINFORCEMENT

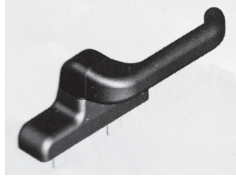



AKSESUARLAR / ACCESSORIES

AKSESUAR ACCESSORY	SİPARİŞ KODU ORDER CODE	PAKET ADET UNITS	AKSESUAR ACCESSORY	SİPARİŞ KODU ORDER CODE	PAKET ADET UNITS
	MK 01990000			MK 05008	
PARALEL MAKAS			KIVRIM KOL (KEY ANAHTARLI)		
	MK GS HD-10''P TİPİ	08534000N		MK 01170N	
	GS HD-12''P TİPİ	08535000N			
	GS HD-14''P TİPİ	08536000N			
	GS HD-16''P TİPİ	08537000N			
	GS HD-18''P TİPİ	08538000N			
	GS HD-20''P TİPİ	08539000N			
	GS HD-22''P TİPİ	08540000N			
	GS HD-24''P TİPİ	08541000N			
TERS VASİSTAS MAKAS	GS HD-28''P TİPİ	08542000N		MK 01001	
	MK 01991		EKSENEL KOL		
PARALEL MAKAS				MK 01192	
	MK 05007		KİLİTLİ KOL		
KIVRIM KOL				LAZER 2 KADEMELİ TELESKOPIK MAKAS MK 01951	
				LAZER 5 KADEMELİ TELESKOPIK MAKAS MK 01954	
			LİMİTLEME MAKASI		

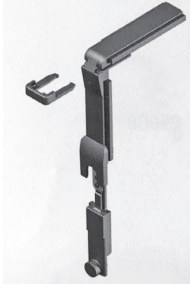

MK CEPHE 65 ÇELİK TAKVİYELİ CEPHE SİSTEMİ  
FACADE SYSTEM WITH STEEL REINFORCEMENT

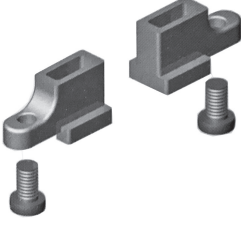
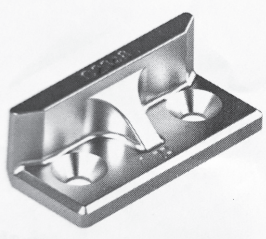
AKSESUARLAR / ACCESSORIES

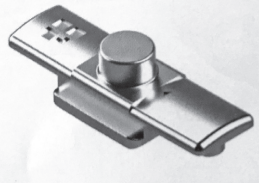
AKSESUAR ACCESSORY	SİPARİŞ KODU ORDER CODE	PAKET ADET UNITS	AKSESUAR ACCESSORY	SİPARİŞ KODU ORDER CODE	PAKET ADET UNITS
	MK 04019K			MK 04030 MK 04682	
KÖŞE DÖNME			AYARLI PİM		
	MK 04020K			MK 01374	
KÖŞE DÖNME			ÜST KİLİTLEME ELEMANI		
	MK 02236 MK 02262			MK 01214	
BAĞLANTI ELEMANI			KİLİTLİ KARŞILIK		
	MK 01266K MK 01267 MK 01268			MK 04047K	
SABİT KARŞILIK			KİLİT PİMİ VE KİLİT KARŞILIK		

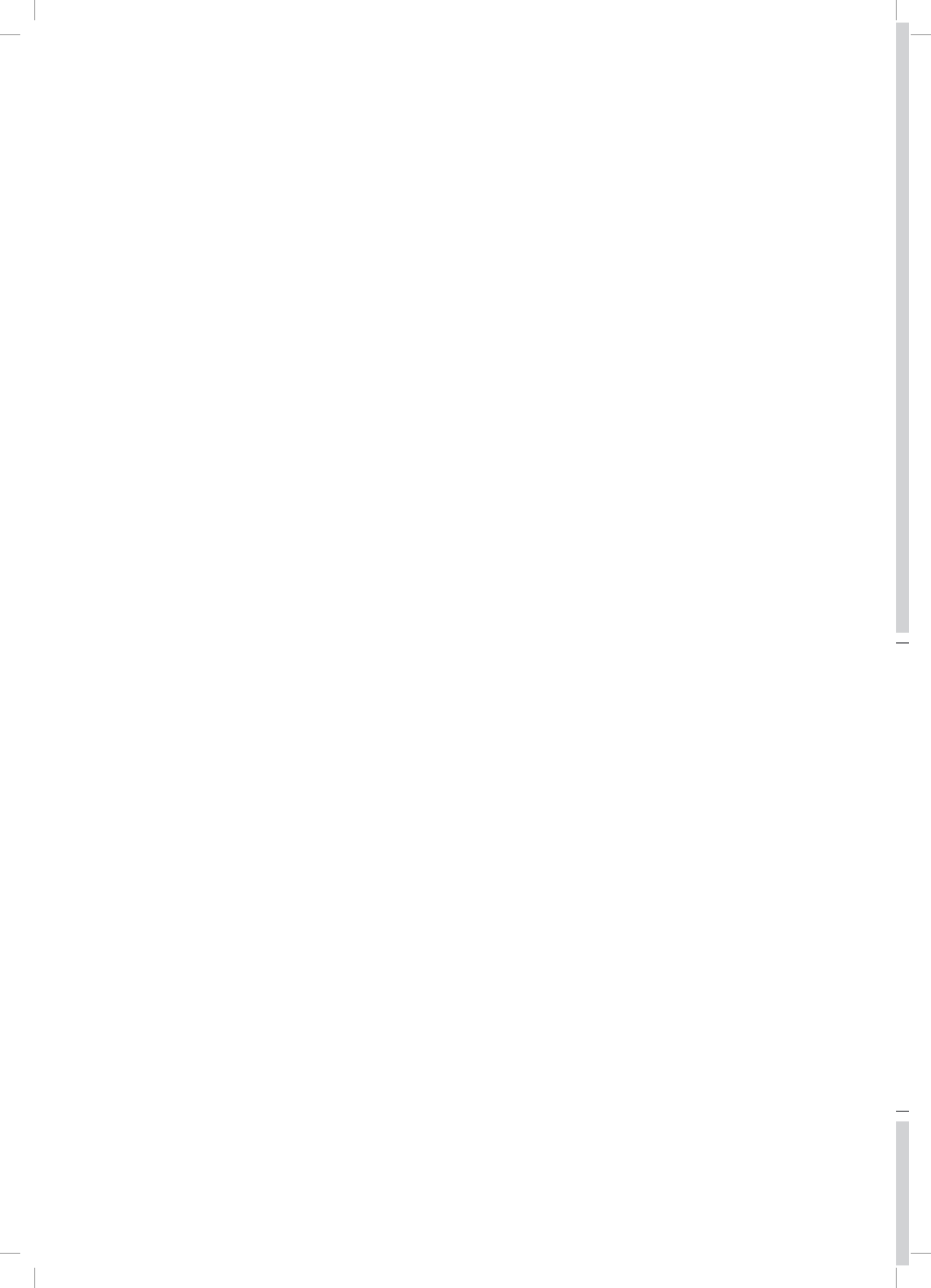

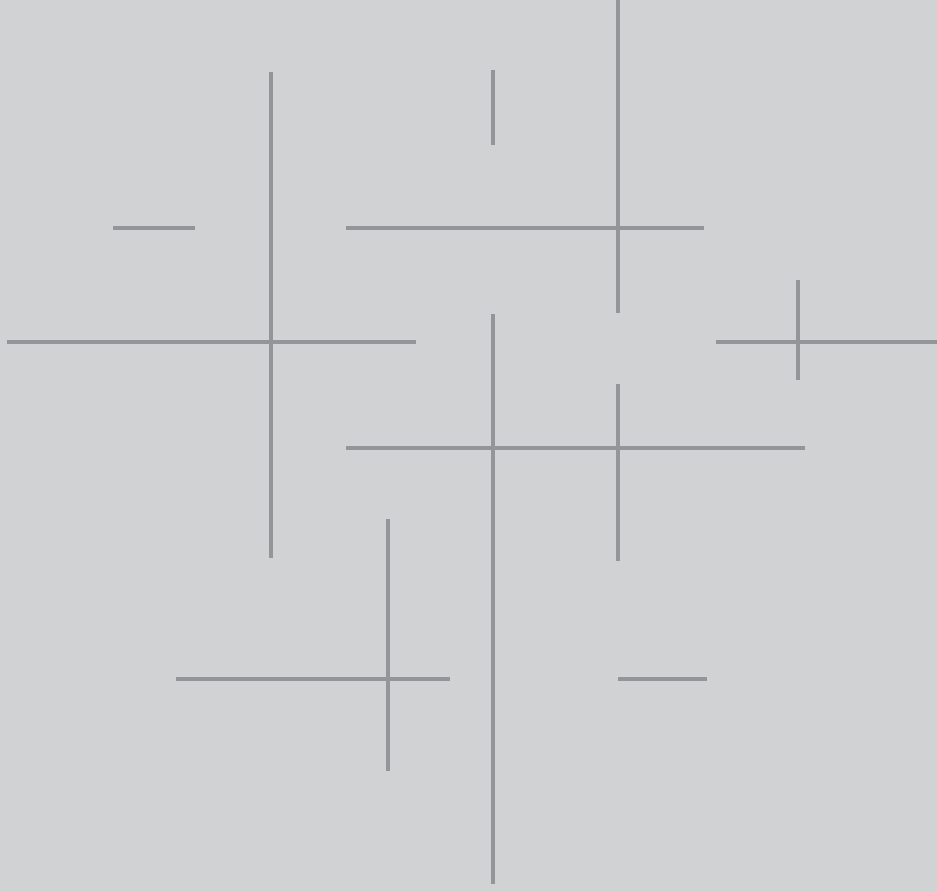

# GÜNEŞ KIRICI SİSTEMLERİ







## SOLAR SHADING SYSTEMS

**115-142**  
**İÇİNDEKİLER**  
CONTENTS







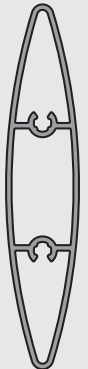

**139-142**  
**SİSTEM DETAYLARI**  
SYSTEM DETAILS

**123-138**  
**PROFİL KESİT DETAYLARI**  
PROFILE DETAILS DRAWINGS







## GÜNEŞ KIRICI SİSTEMLERİ SOLAR SHADING SYSTEMS

ŞEKİL DRAWING	KOD CODE	 mm	 mm	 cm <sup>4</sup>	 cm <sup>4</sup>	 kg/m
	<b>1000-150</b>	22.00	100.60			1.300
	<b>1000-149</b>	16.87	100.00			0.800
	<b>1000-172</b>	20.00	100.00			1.045



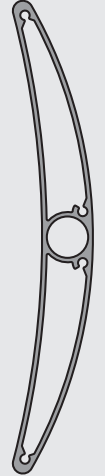
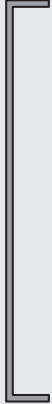

## GÜNEŞ KIRICI SİSTEMLERİ SOLAR SHADING SYSTEMS

ŞEKİL DRAWING	KOD CODE	 mm	 mm	 cm <sup>4</sup>	 cm <sup>4</sup>	 kg/m
	<b>1000-170</b>	20.00	80.00			0.925
	<b>1000-151</b>	22.00	180.00			2.050
	<b>1000-134</b>	17.20	160.00			1.695



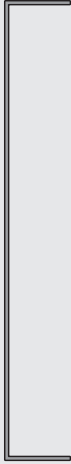
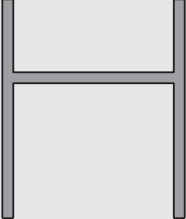
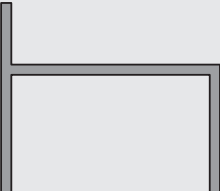

## GÜNEŞ KIRICI SİSTEMLERİ SOLAR SHADING SYSTEMS

ŞEKİL DRAWING	KOD CODE	 mm	 mm	 cm <sup>4</sup>	 cm <sup>4</sup>	 kg/m
	<b>1061</b>	30.00	150.00			1.545
	<b>1000-174</b>	27.10	160.00			1.705
	<b>1000-152</b>	11.70	110.00			0.635

## GÜNEŞ KIRICI SİSTEMLERİ SOLAR SHADING SYSTEMS





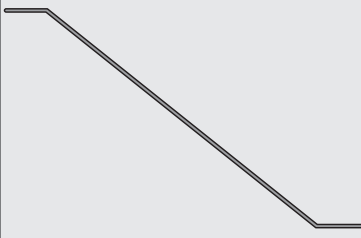



ŞEKİL DRAWING	KOD CODE	 mm	 mm	 cm <sup>4</sup>	 cm <sup>4</sup>	 kg/m
	<b>1000-153</b>	20.00	140.00			0.575
	<b>800-278</b>	50.00	60.00			1.345
	<b>1000-154</b>	60.00	51.80			1.070

## GÜNEŞ KIRICI SİSTEMLERİ SOLAR SHADING SYSTEMS





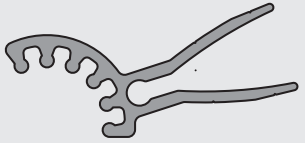

ŞEKİL DRAWING	KOD CODE	 mm	 mm	 cm <sup>4</sup>	 cm <sup>4</sup>	 kg/m	SAYFA PAGE
	1054	74.50	46.20			0.575	563
	1000-155	166.50	101.50			0.865	563
	1000-156	150.00	132.00			2.755	564



## GÜNEŞ KIRICI SİSTEMLERİ SOLAR SHADING SYSTEMS

ŞEKİL DRAWING	KOD CODE	 mm	 mm	 cm <sup>4</sup>	 cm <sup>4</sup>	 kg/m	SAYFA PAGE
	<b>11-223</b>	56.60	12.70			0.315	565
	<b>1000-147</b>	80.00	36.50			1.455	565
	<b>1000-148</b>	73.00	30.00			1.420	565

## GÜNEŞ KIRICI SİSTEMLERİ SOLAR SHADING SYSTEMS

ŞEKİL DRAWING	KOD CODE	 mm	 mm	 cm <sup>4</sup>	 cm <sup>4</sup>	 kg/m	SAYFA PAGE
	<b>1000-190</b>	50.00	152.80			3.560	566

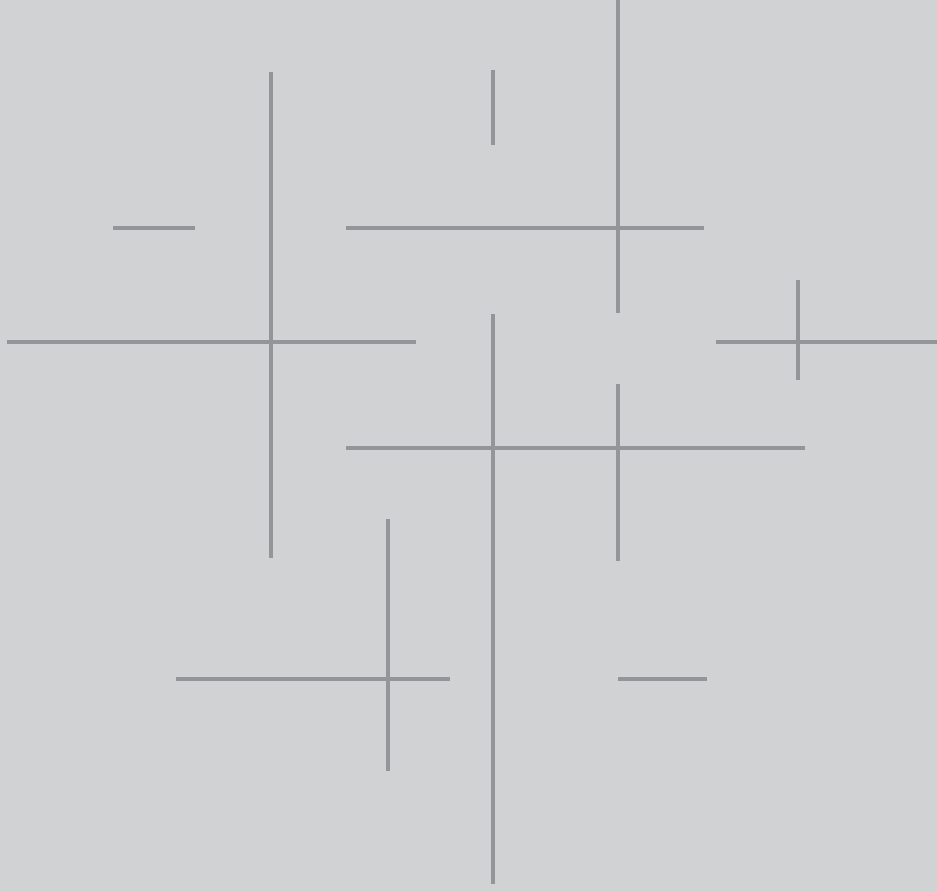

**GÜNEŞ KIRICI SİSTEMLERİ**  
SOLAR SHADING SYSTEMS

**123-138**  
PROFİL KESİT DETAYLARI  
PROFILE DETAILS DRAWINGS

## GÜNEŞ KIRICI SİSTEMLERİ SOLAR SHADING SYSTEMS

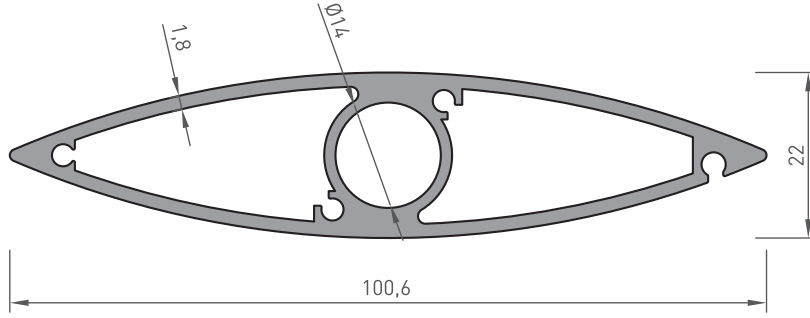

Profil Kodu	1000-150
Tanım:	Güneş Kırıcı
Ağırlık:	1.300 kg/m

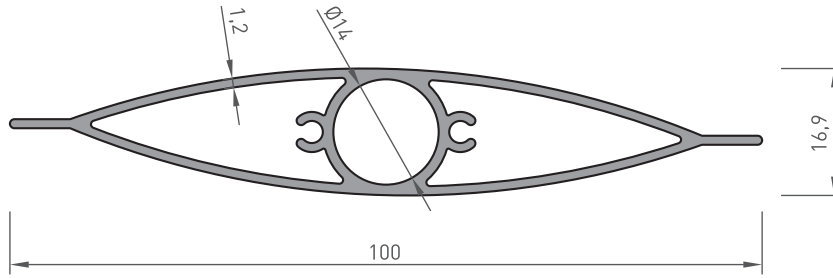

Profil Kodu	1000-149
Tanım:	Güneş Kırıcı
Ağırlık:	0.800 kg/m

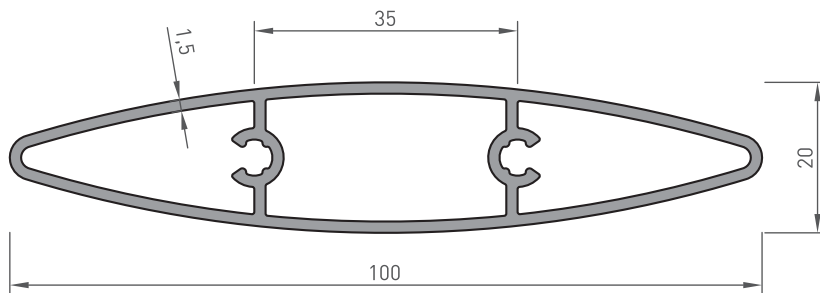

Profil Kodu	1000-172
Tanım:	Güneş Kırıcı
Ağırlık:	1.045 kg/m

## GÜNEŞ KIRICI SİSTEMLERİ SOLAR SHADING SYSTEMS

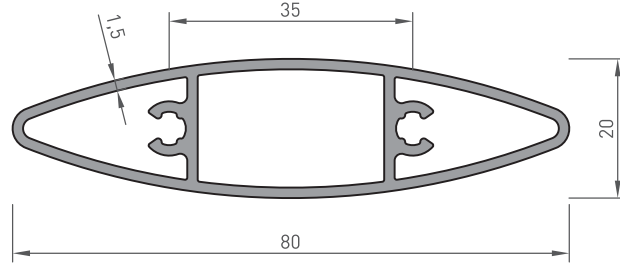

Profil Kodu	1000-170
Tanım:	Güneş Kırıcı
Ağırlık:	0.925 kg/m

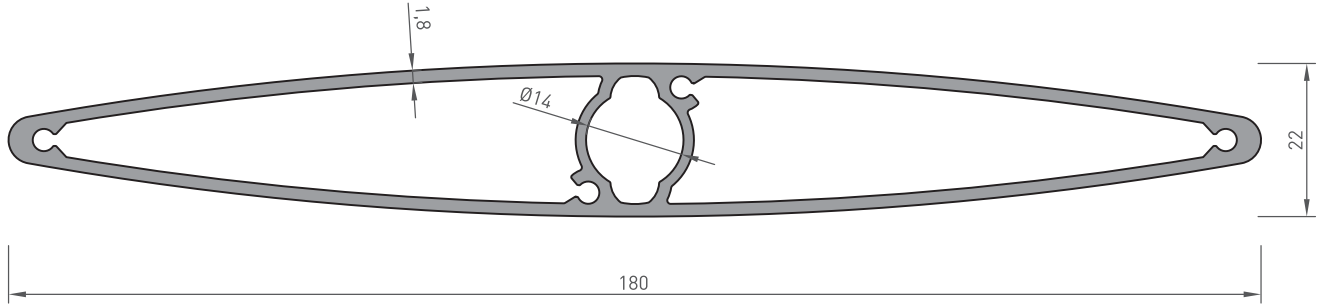

Profil Kodu	1000-151
Tanım:	Güneş Kırıcı
Ağırlık:	2.050 kg/m

\*BELİRTİLEN AĞIRLIKLAR, TEORİK PRES ÇIKIŞ AĞIRLIKLARIDIR.  
\*BOYALI PROFİLLERDE AĞIRLIĞA %5 İLAVE EDİLMESİ GEREKLİDİR.

## GÜNEŞ KIRICI SİSTEMLERİ SOLAR SHADING SYSTEMS

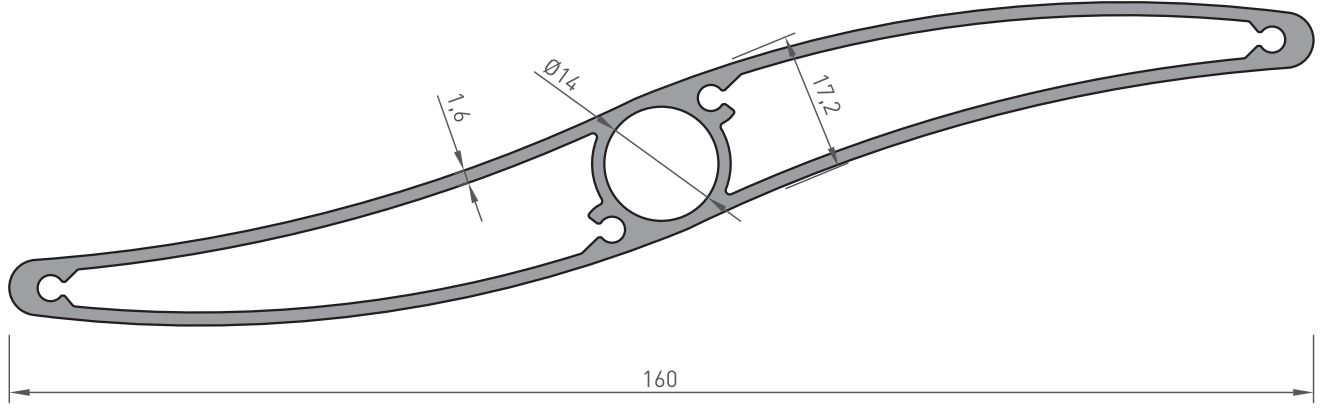

Profil Kodu	1000-134
Tanım:	Güneş Kırıcı
Ağırlık:	1.695 kg/m

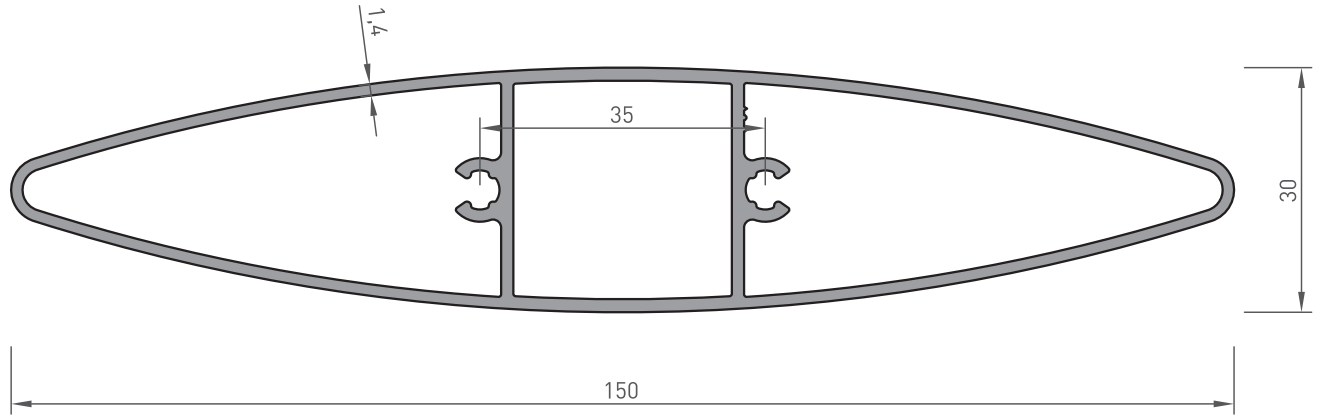

Profil Kodu	1061
Tanım:	Güneş Kırıcı
Ağırlık:	1.545 kg/m

## GÜNEŞ KIRICI SİSTEMLERİ SOLAR SHADING SYSTEMS

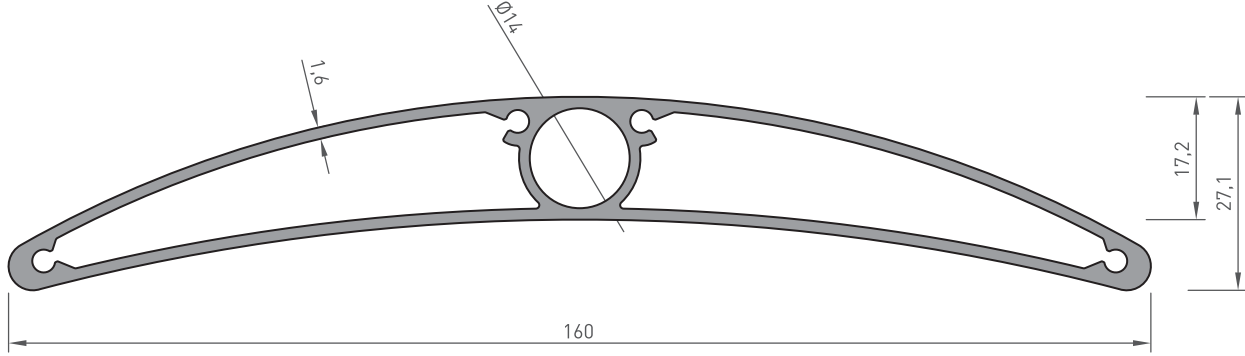

Profil Kodu	1000-174
Tanım:	Güneş Kırıcı
Ağırlık:	1.705 kg/m

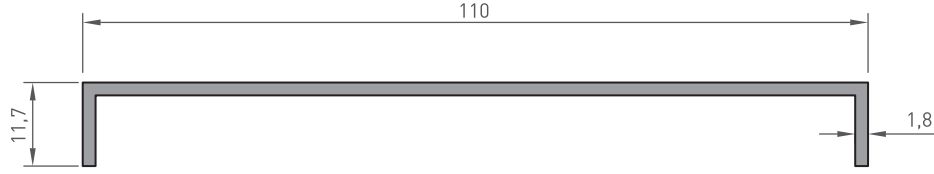

Profil Kodu	1000-152
Tanım:	110'lık Güneş Kırıcı Kasa
Ağırlık:	0.635 kg/m

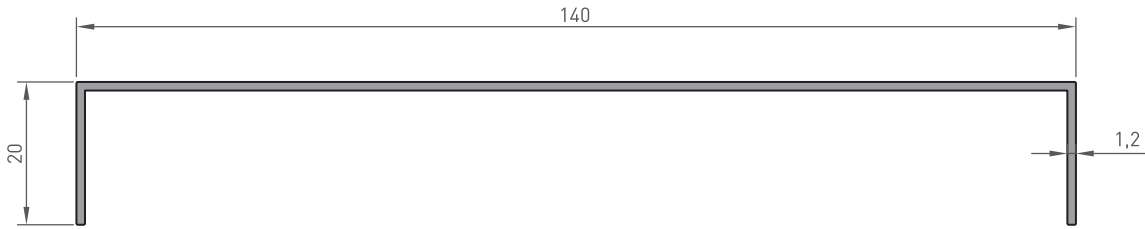

Profil Kodu	1000-153
Tanım:	180'lık Güneş Kırıcı Kasa
Ağırlık:	0.555 kg/m

\*BELİRTİLEN AĞIRLIKLAR, TEORİK PRES ÇIKIŞ AĞIRLIKLARIDIR.  
\*BOYALI PROFİLLERDE AĞIRLIĞA %5 İLAVE EDİLMESİ GEREKLİDİR.

## GÜNEŞ KIRICI SİSTEMLERİ SOLAR SHADING SYSTEMS

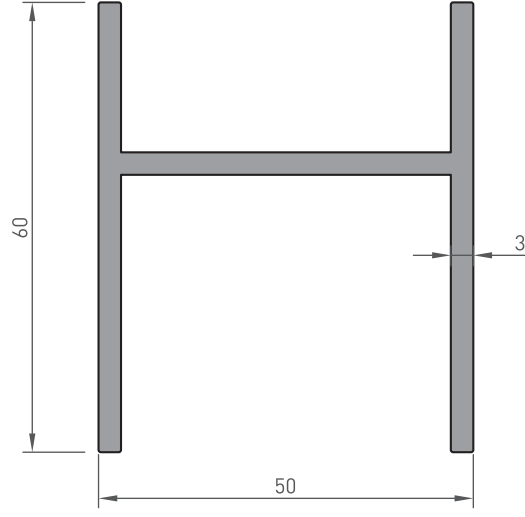

Profil Kodu	800-278
Tanım:	"H" Profili
Ağırlık:	1.345 kg/m

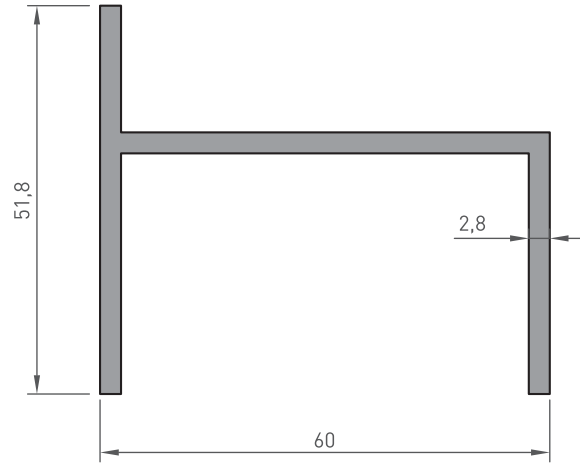

Profil Kodu	800-278
Tanım:	Güneş Kırıcı Kasa
Ağırlık:	1.070 kg/m



## GÜNEŞ KIRICI SİSTEMLERİ SOLAR SHADING SYSTEMS

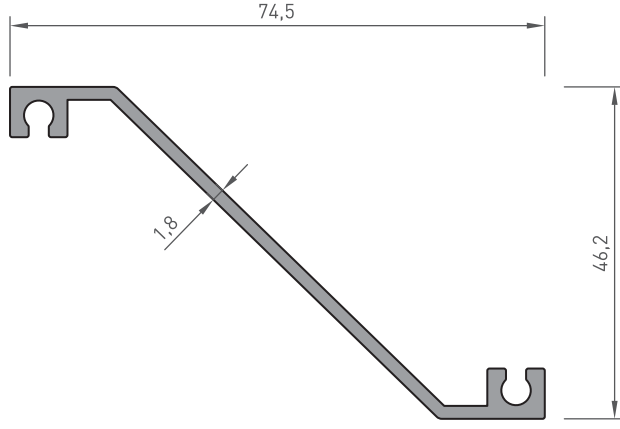

Profil Kodu	1054
Tanım:	Güneş Kırıcı Yaprak
Ağırlık:	0.590 kg/m

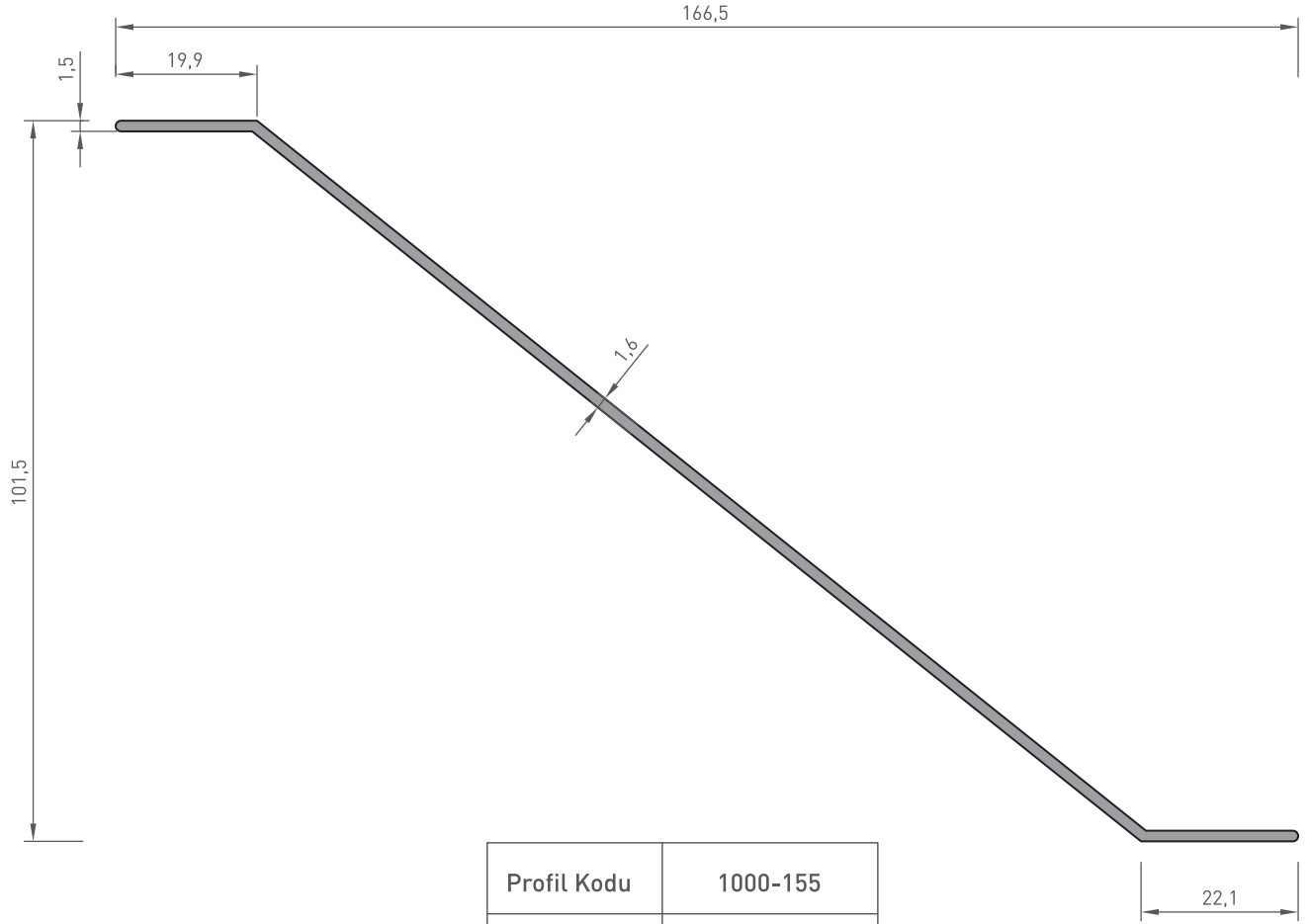

Profil Kodu	1000-155
Tanım:	Güneş Kırıcı Profil
Ağırlık:	0.865 kg/m

\*BELİRTİLEN AĞIRLIKLAR, TEORİK PRES ÇIKIŞ AĞIRLIKLARIDIR.  
\*BOYALI PROFİLLERDE AĞIRLIĞA %5 İLAVE EDİLMESİ GEREKLİDİR.

# GÜNEŞ KIRICI SİSTEMLERİ

## SOLAR SHADING SYSTEMS

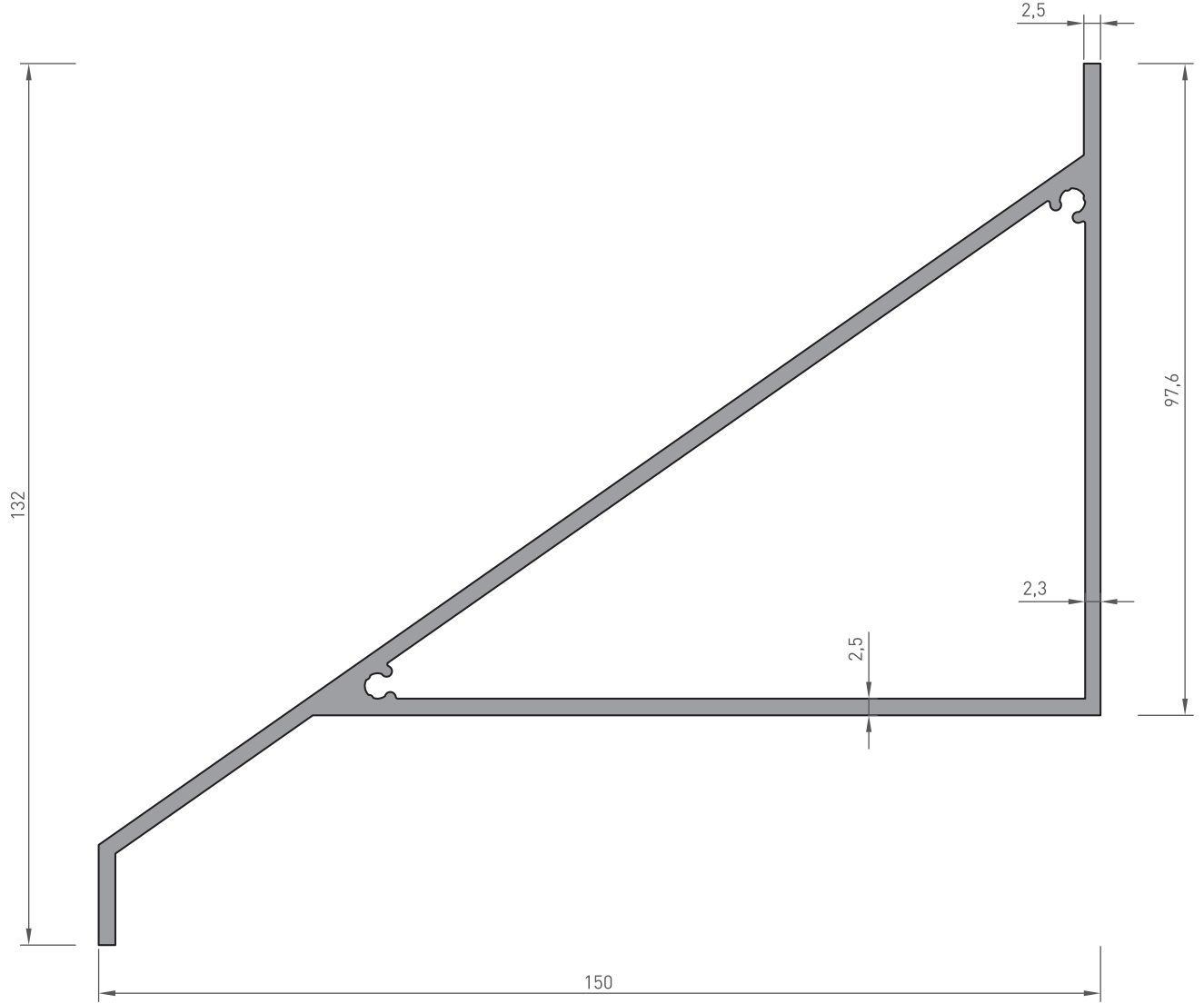

Profil Kodu	1000-156
Tanım:	Güneş Kırıcı Profil
Ağırlık:	2.755 kg/m

## GÜNEŞ KIRICI SİSTEMLERİ SOLAR SHADING SYSTEMS

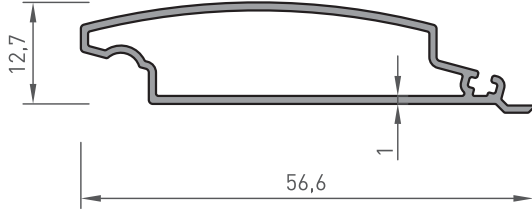

Profil Kodu	11-223
Tanım:	Güneş Kırıcı
Ağırlık:	0.315 kg/m

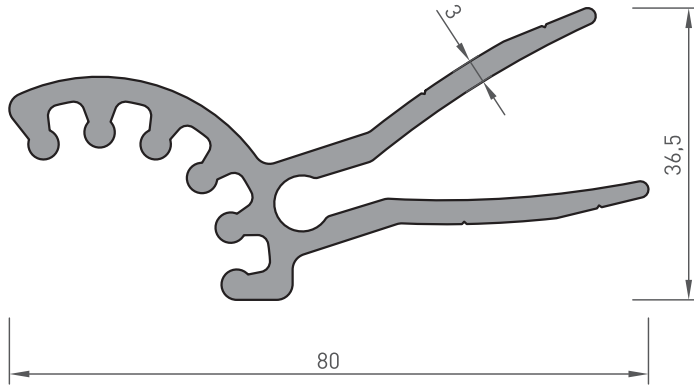

Profil Kodu	1000-147
Tanım:	Güneş Kırıcı Üst Bağlantı Aparatı
Ağırlık:	1.455 kg/m

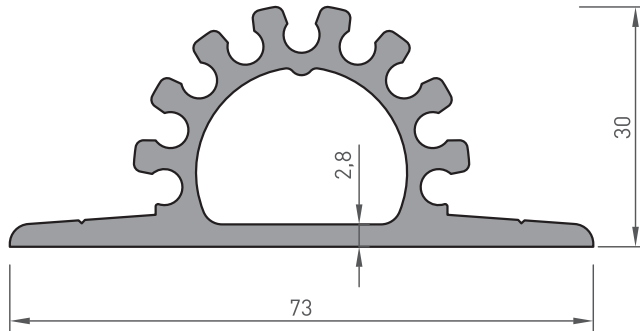

Profil Kodu	1000-148
Tanım:	Güneş Kırıcı Alt Bağlantı Aparatı
Ağırlık:	1.420 kg/m

\*BELİRTİLEN AĞIRLIKLAR, TEORİK PRES ÇIKIŞ AĞIRLIKLARIDIR.  
\*BOYALI PROFİLLERDE AĞIRLIĞA %5 İLAVE EDİLMESİ GEREKLİDİR.

# GÜNEŞ KIRICI SİSTEMLERİ

## SOLAR SHADING SYSTEMS

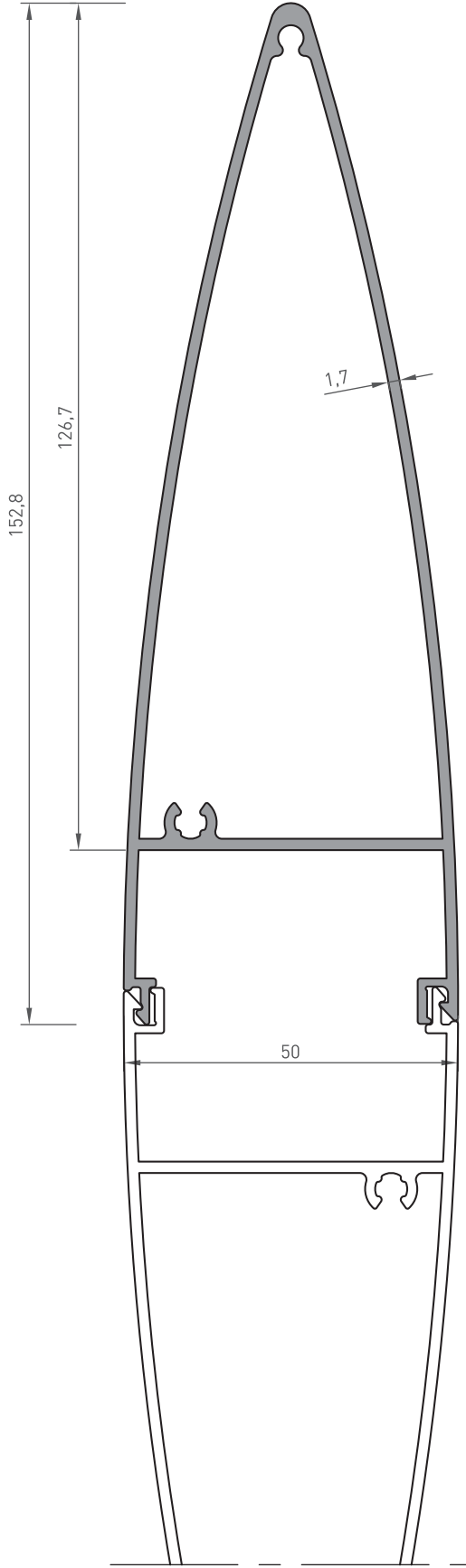

Profil Kodu	1000-190
Tanım:	300'lük Güneş Kırıcı
Ağırlık:	3.560 kg/m

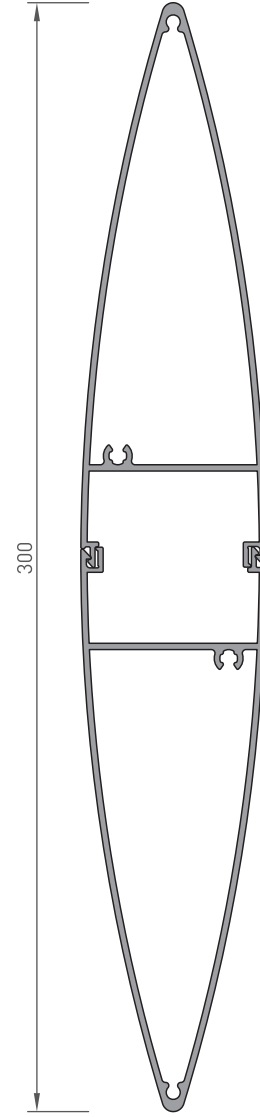

ÖLÇEK:1/2

## GÜNEŞ KIRICI SİSTEMLERİ SOLAR SHADING SYSTEMS

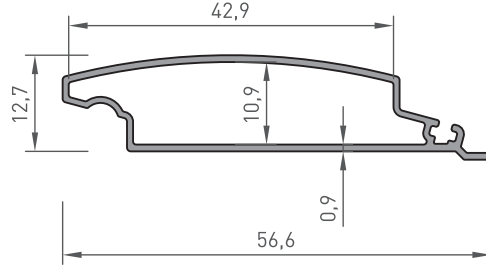

11-223  
GÜNEŞ KIRICI  
0.315 kg / m

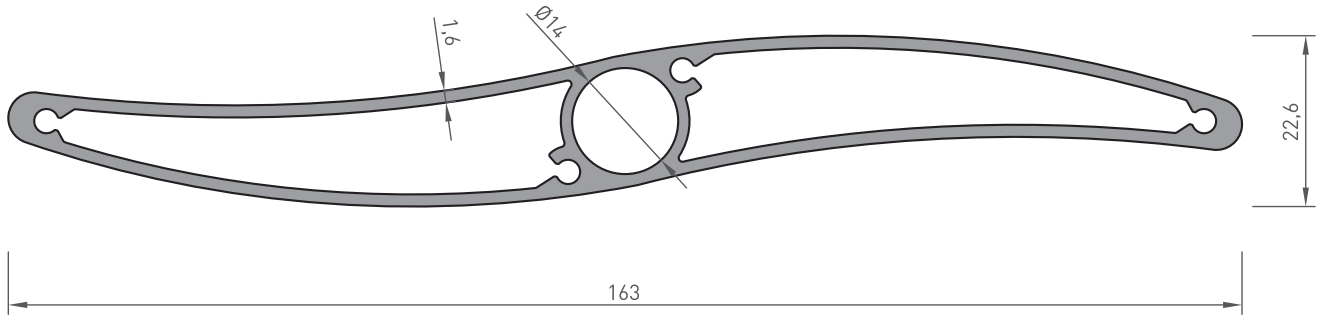

1000 -134  
GÜNEŞ KIRICI  
1.720 kg/m

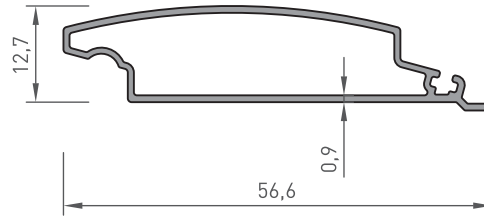

1058  
GÜNEŞ KIRICI  
0.315 kg / m

\*BELİRTİLEN AĞIRLIKLAR, TEORİK PRES ÇIKIŞ AĞIRLIKLARIDIR.  
\*BOYALI PROFİLLERDE AĞIRLIĞA %5 İLAVE EDİLMESİ GEREKLİDİR.

## GÜNEŞ KIRICI SİSTEMLERİ SOLAR SHADING SYSTEMS

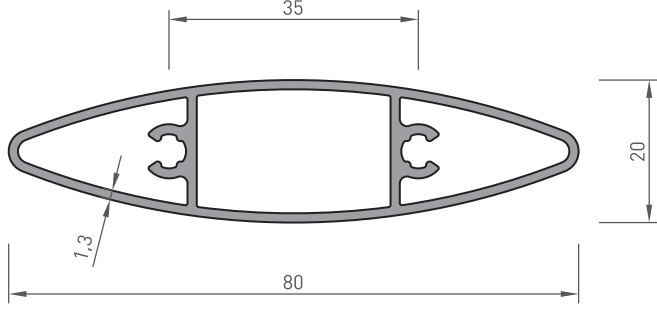

1000-170  
GÜNEŞ KIRICI  
0.820 kg/m

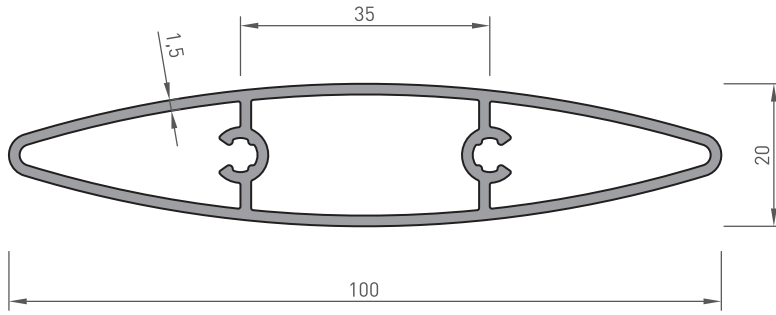

1000-172  
GÜNEŞ KIRICI  
1.045 kg/m

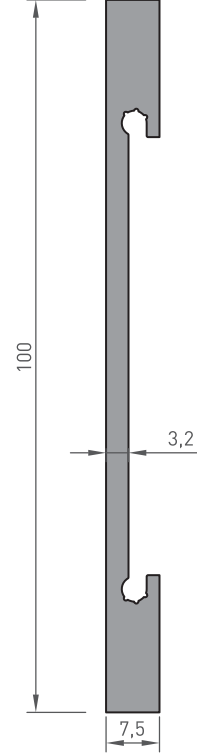

1000-185  
GÜNEŞ KIRICI LAMA  
1.265 kg/m

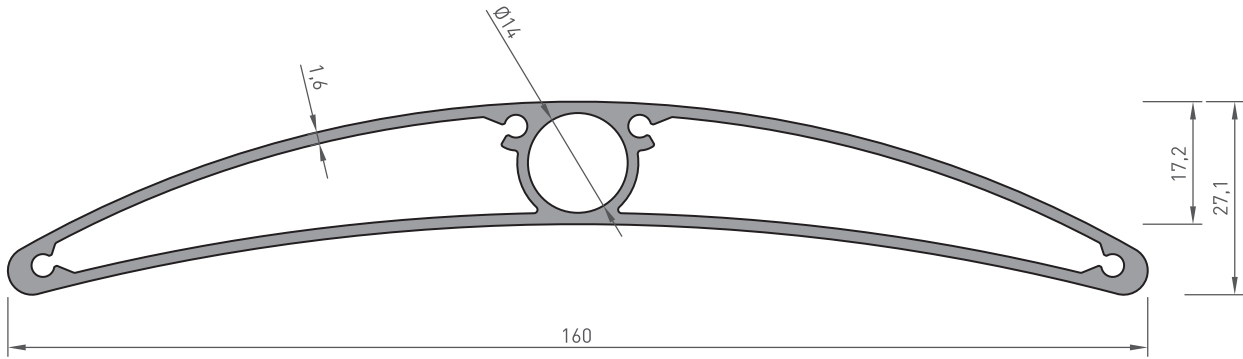

1000-174  
160 GÜNEŞ KIRICI  
1.725 kg/m

## GÜNEŞ KIRICI SİSTEMLERİ SOLAR SHADING SYSTEMS

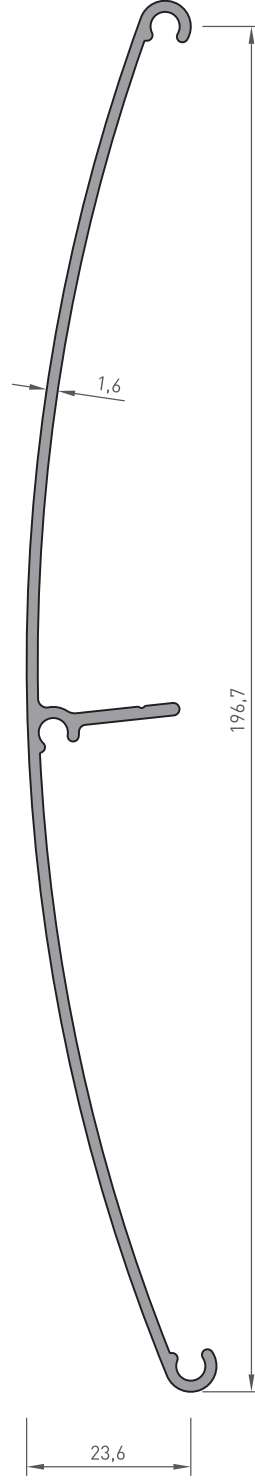

1000-304  
GÜNEŞ KIRICI-YAPRAK  
1.100 kg / m

\*BELİRTİLEN AĞIRLIKLAR, TEORİK PRES ÇIKIŞ AĞIRLIKLARIDIR.  
\*BOYALI PROFİLLERDE AĞIRLIĞA %5 İLAVE EDİLMESİ GEREKLİDİR.

GÜNEŞ KIRICI SİSTEMLERİ  
SOLAR SHADING SYSTEMS

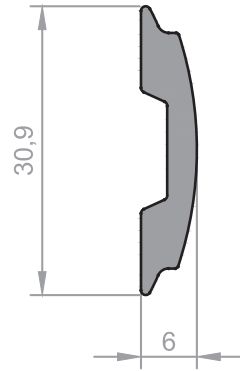
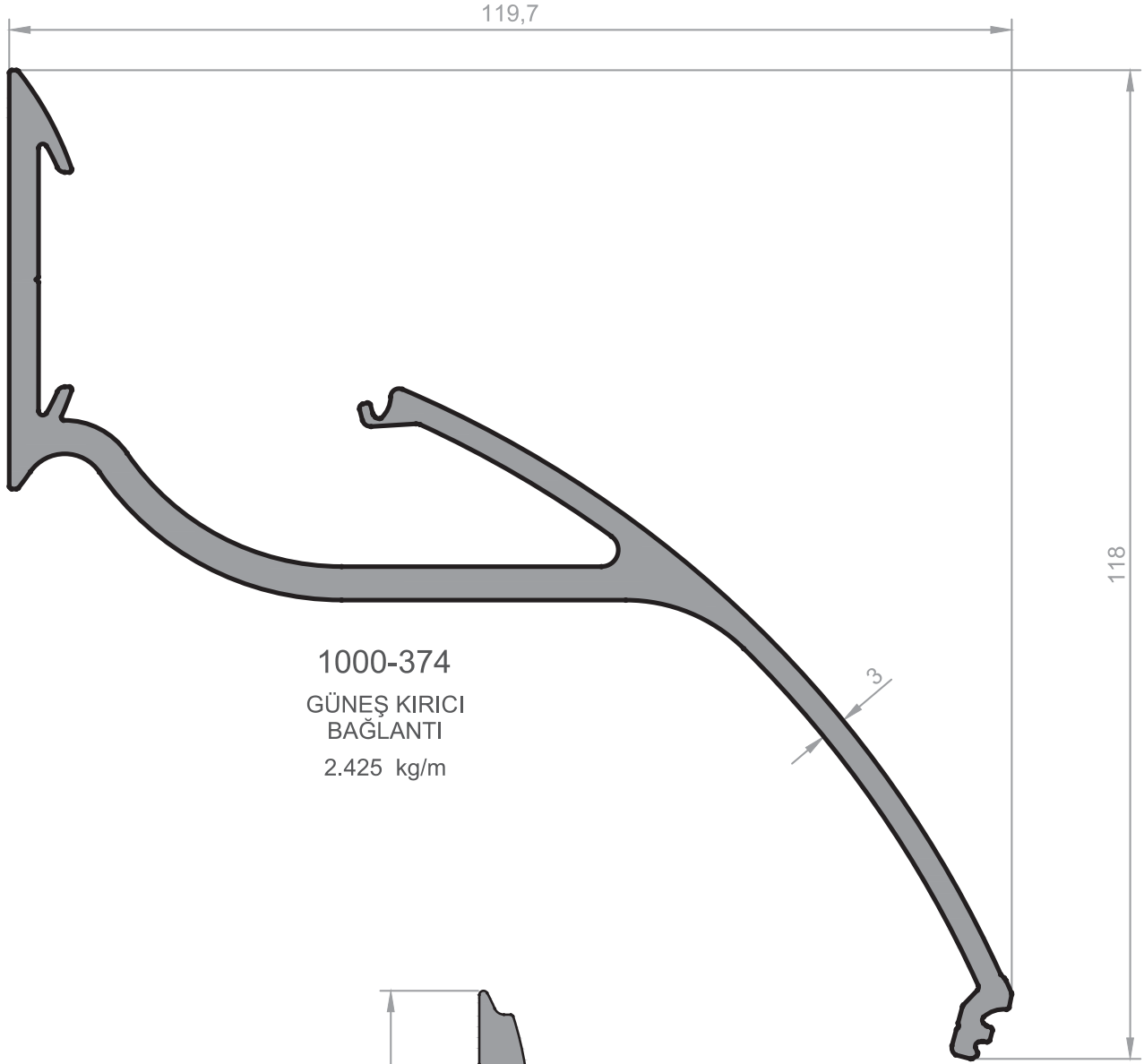



## GÜNEŞ KIRICI SİSTEMLERİ SOLAR SHADING SYSTEMS

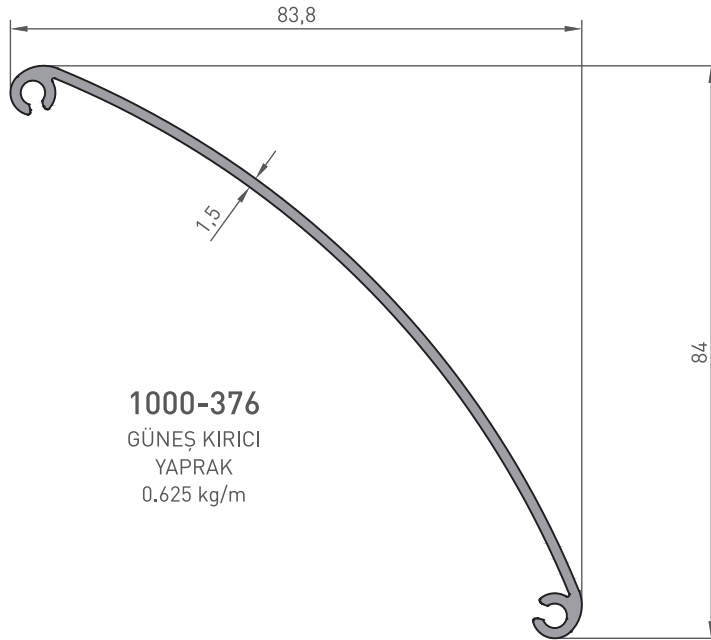
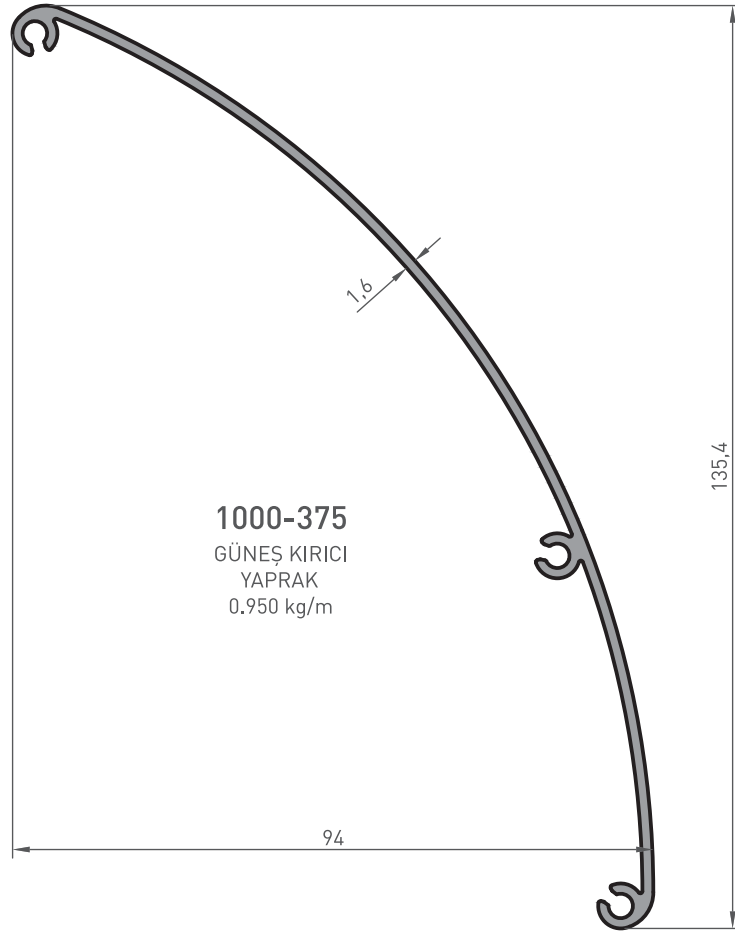

\*BELİRTİLEN AĞIRLIKLAR, TEORİK PRES ÇIKIŞ AĞIRLIKLARIDIR.  
\*BOYALI PROFİLLERDE AĞIRLIĞA %5 İLAVE EDİLMESİ GEREKLİDİR.

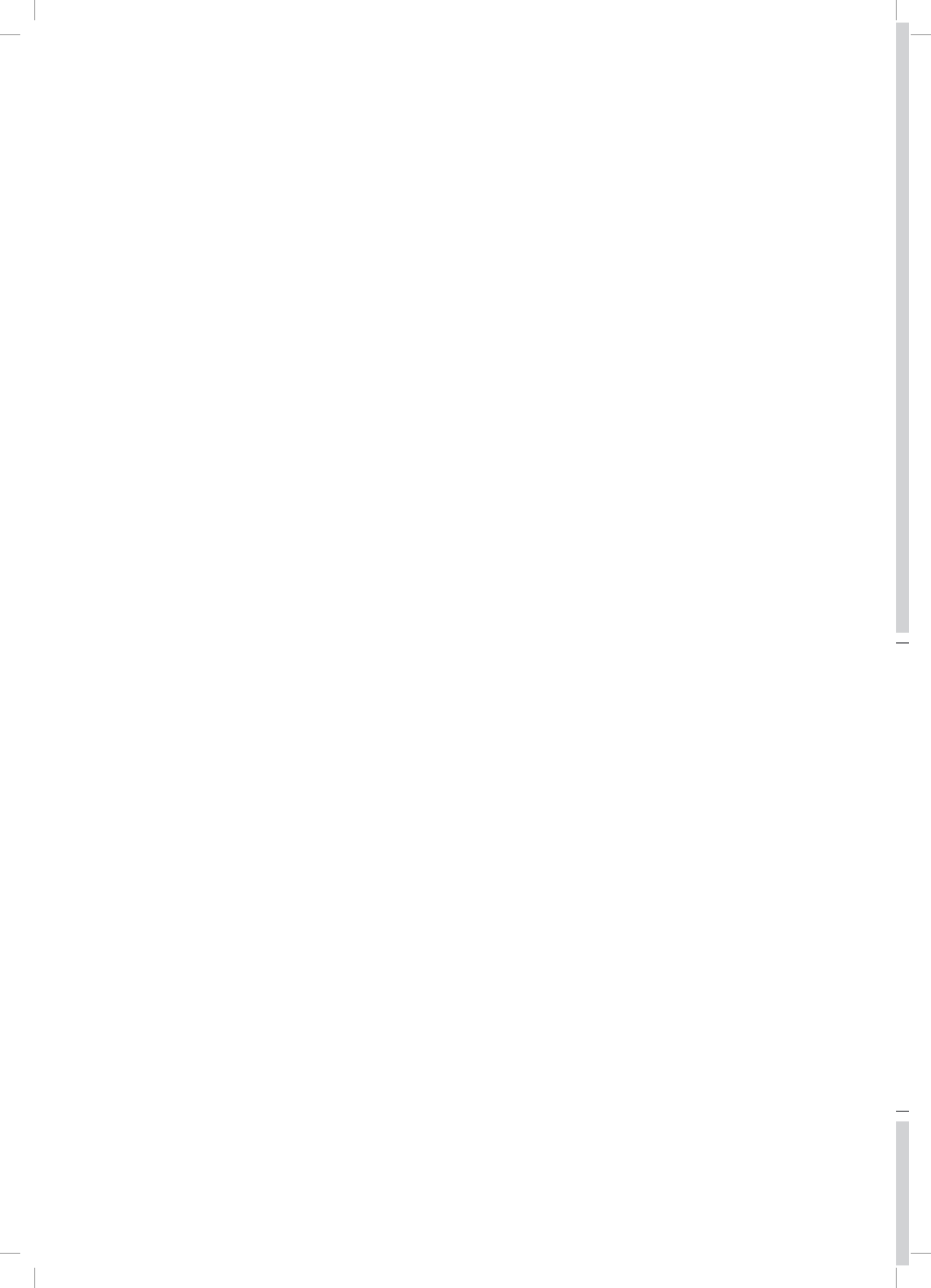

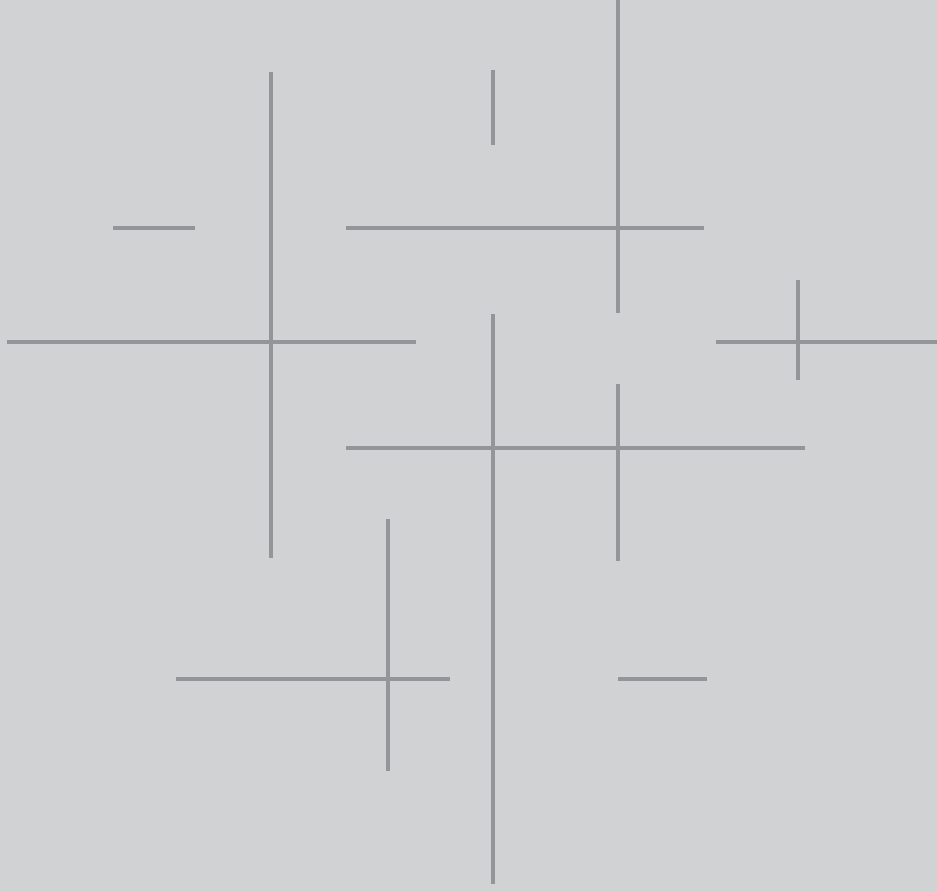

**GÜNEŞ KIRICI SİSTEMLERİ**  
SOLAR SHADING SYSTEMS

**139-142**  
**SİSTEM DETAYLARI**  
SYSTEM DETAILS

GÜNEŞ KIRICI SİSTEMLERİ  
SOLAR SHADING SYSTEMS

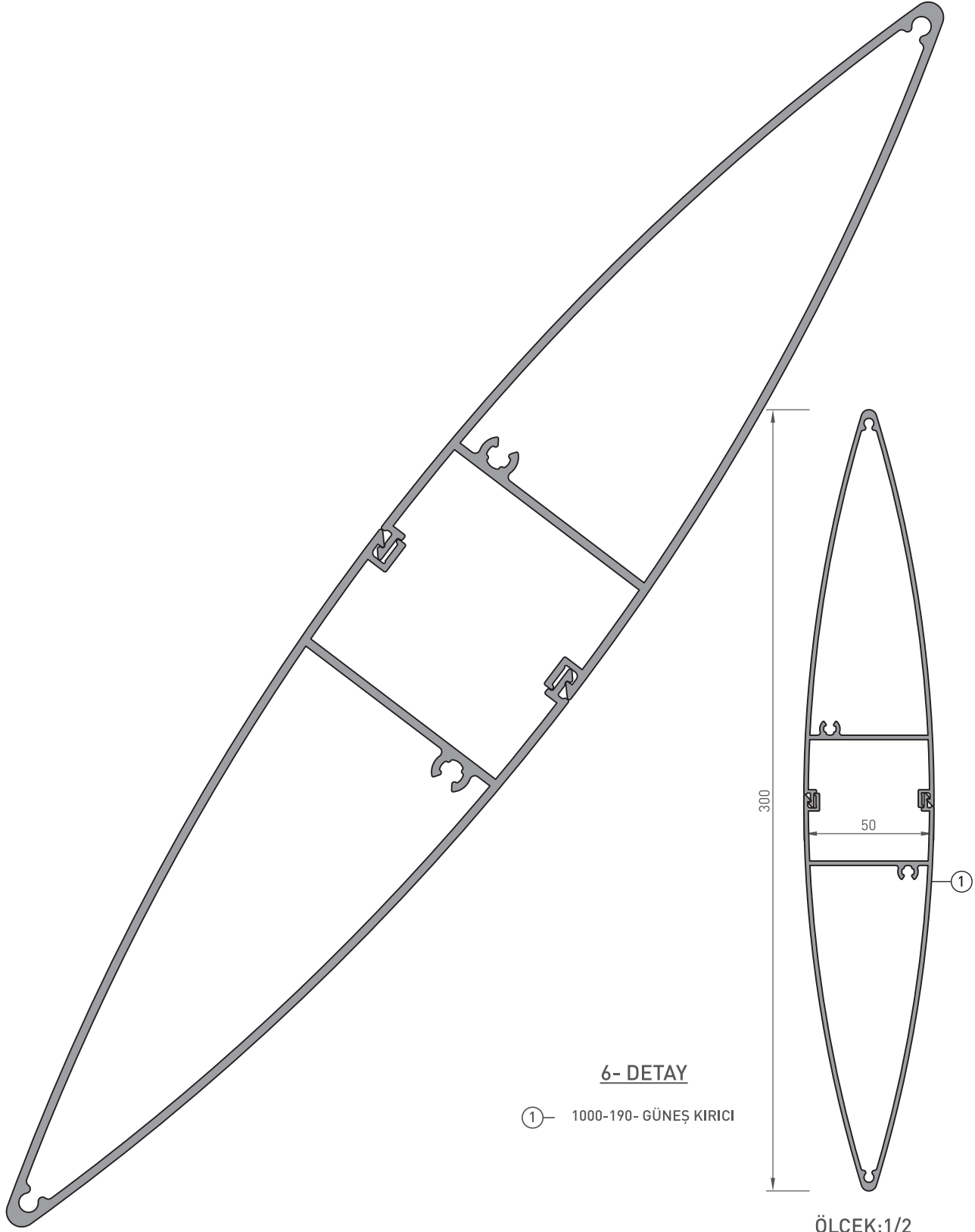

6- DETAY

① - 1000-190- GÜNEŞ KIRICI

ÖLÇEK:1/2

## GÜNEŞ KIRICI SİSTEMLERİ SOLAR SHADING SYSTEMS

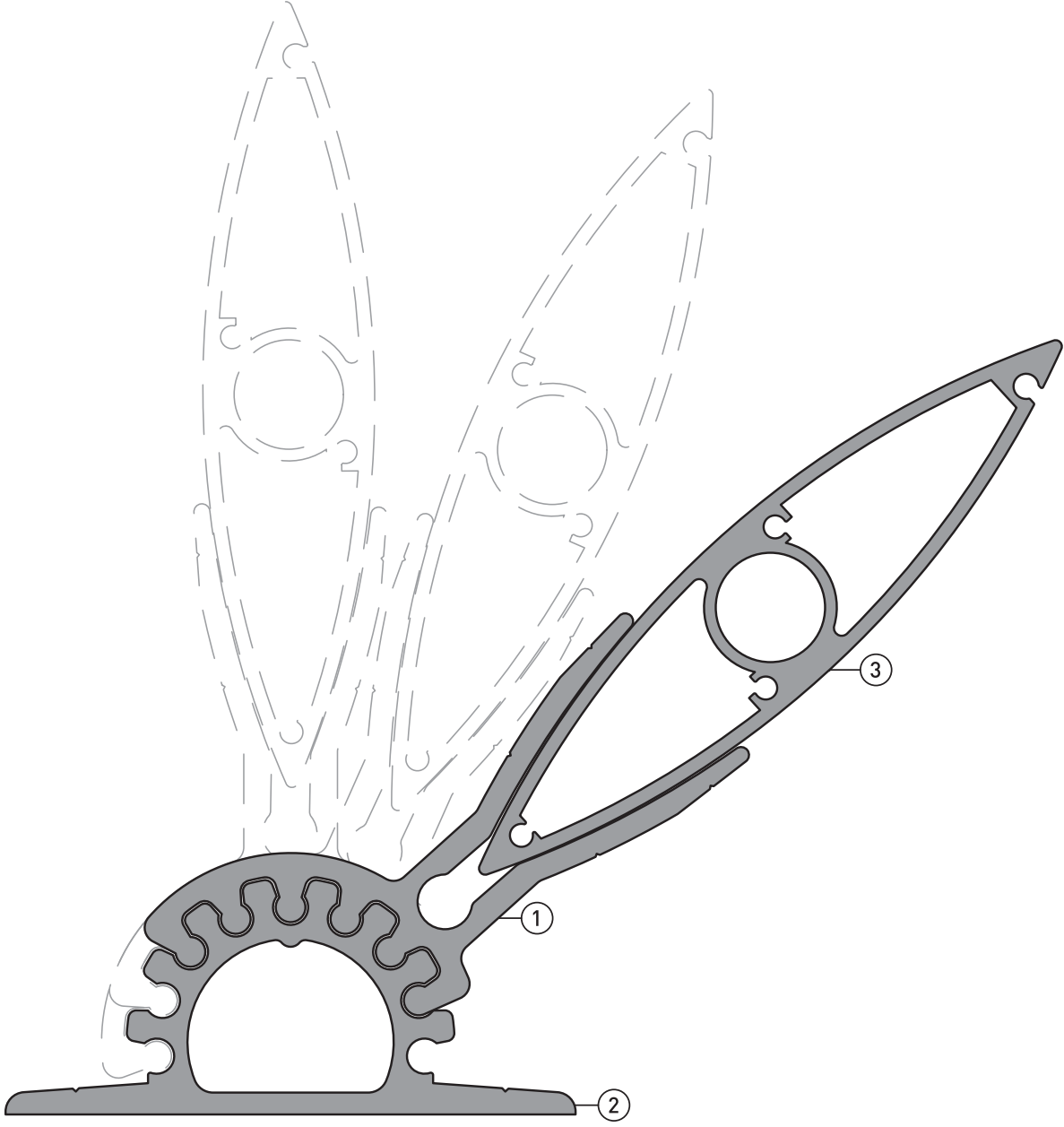

### 7 DETAY

- ①— 1000-147 - GÜNEŞ KIRICI ADAPTÖRÜ
- ②— 1000-148 - GÜNEŞ KIRICI ADAPTÖRÜ
- ③— 1000-150 - GÜNEŞ KIRICI

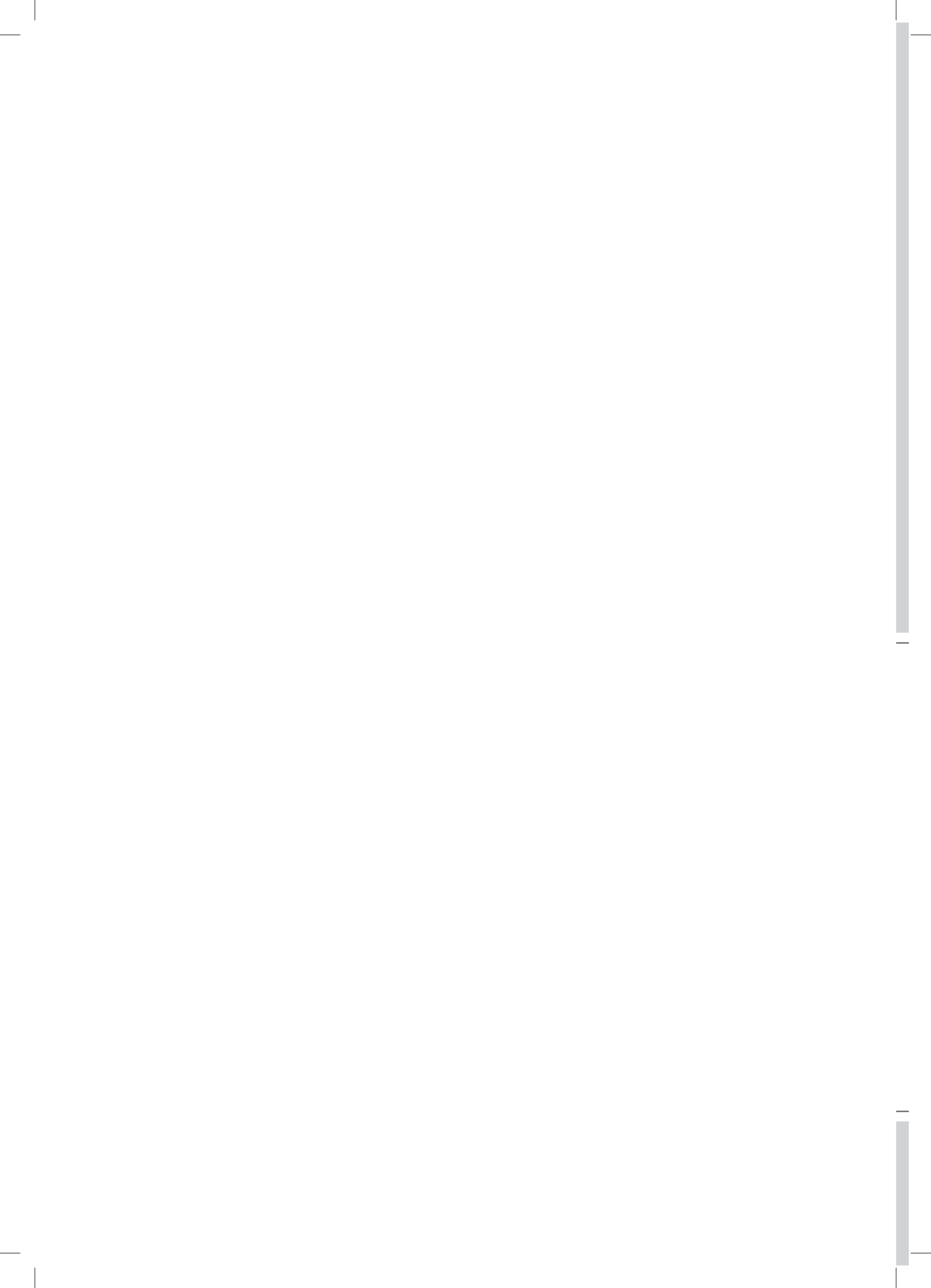

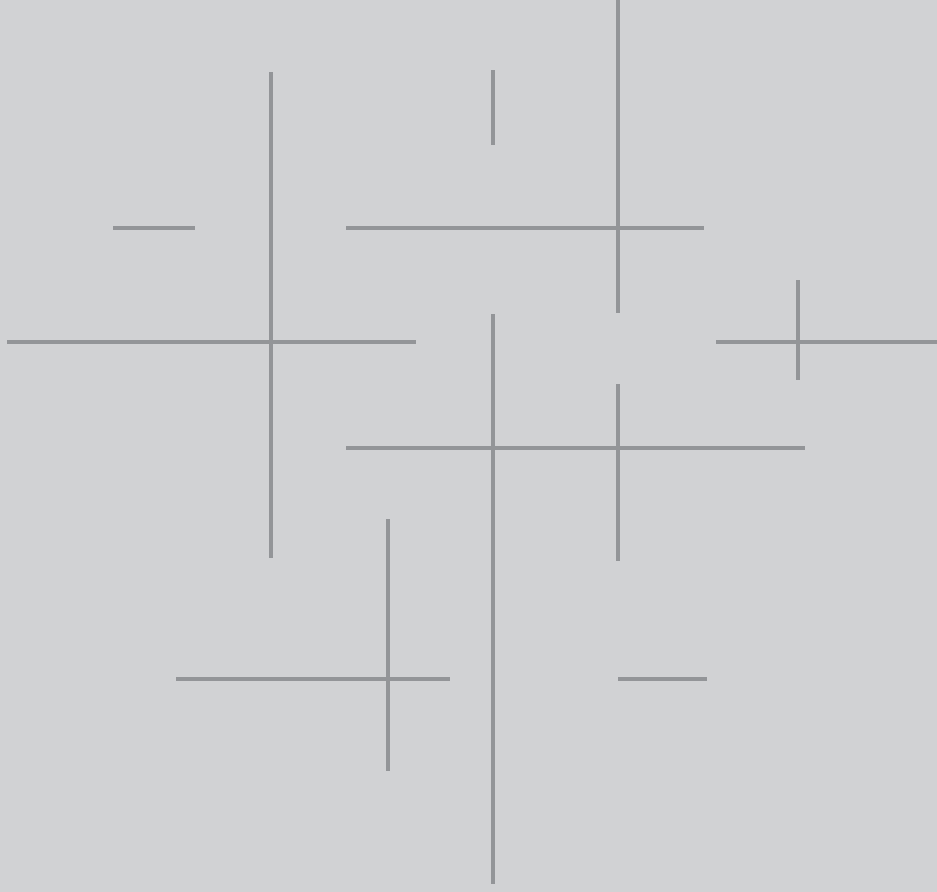

# KOMPOZİT PANEL PROFİLLERİ

## COMPOSITE PANEL PROFILES







**143-165**  
**İÇİNDEKİLER**  
CONTENTS

**161-165**  
**SİSTEM DETAYLARI**  
SYSTEM DETAILS

**151-160**  
**PROFİL KESİT DETAYLARI**  
PROFILE DETAILS DRAWINGS

## KOMPOZİT PANEL PROFİLLERİ

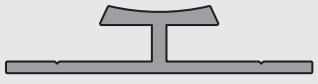

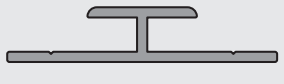
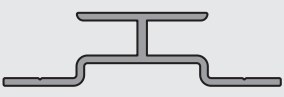
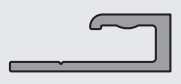



### COMPOSITE PANEL PROFILES

ŞEKİL DRAWING	KOD CODE	 mm	 mm	 cm <sup>4</sup>	 cm <sup>4</sup>	 kg/m	SAYFA PAGE
	<b>1045</b>	42.00	9.20			0.300	590
	<b>1046</b>	42.00	7.80			0.270	590
	<b>1000-171</b>	37.00	7.50			0.220	590
	<b>1047</b>	38.00	10.00			0.195	590
	<b>1048</b>	22.00	7.80			0.160	590





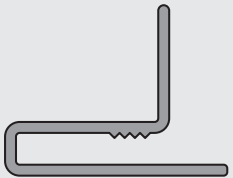
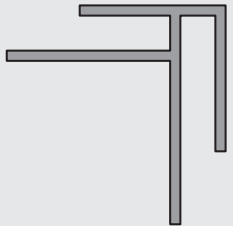
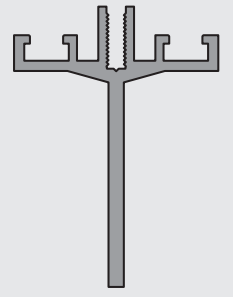
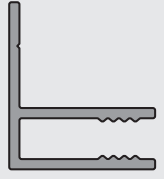

## KOMPOZİT PANEL PROFİLLERİ

### COMPOSITE PANEL PROFILES

ŞEKİL DRAWING	KOD CODE	 mm	 mm	 cm <sup>4</sup>	 cm <sup>4</sup>	 kg/m	SAYFA PAGE
	<b>1049</b>	30.50	23.40			0.300	590
	<b>1000-135</b>	30.00	30.00			0.350	591
	<b>1000-131</b>	40.00	54.90			0.820	591
	<b>1000-136</b>	20.00	22.90			0.245	591
	<b>1000-132</b>	14.20	30.90			0.275	591



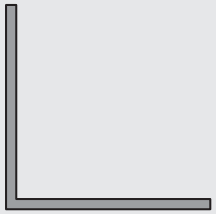

## KOMPOZİT PANEL PROFİLLERİ

### COMPOSITE PANEL PROFILES

ŞEKİL DRAWING	KOD CODE	 mm	 mm	 cm <sup>4</sup>	 cm <sup>4</sup>	 kg/m	SAYFA PAGE
	<b>800-501</b>	40.00	40.00			0.440	591





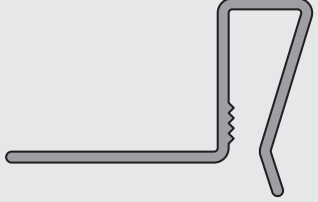



## KOMPOZİT PANEL PROFİLLERİ

### COMPOSITE PANEL PROFILES

ŞEKİL DRAWING	KOD CODE	 mm	 mm	 cm <sup>4</sup>	 cm <sup>4</sup>	 kg/m	SAYFA PAGE
	<b>1000-140</b>	42.00	27.10			0.370	592







## KOMPOZİT PANEL PROFİLLERİ

### COMPOSITE PANEL PROFILES

ŞEKİL DRAWING	KOD CODE	 mm	 mm	 cm <sup>4</sup>	 cm <sup>4</sup>	 kg/m	SAYFA PAGE
	<b>1000-145</b>	60.00	5.70			0.370	593
	<b>1000-146</b>	60.00	16.20			0.410	594
	<b>800-309</b>	8.00	8.00			0.140	594
	<b>11-182</b>	36.00	8.70			0.260	594

## KOMPOZİT PANEL PROFİLLERİ

### COMPOSITE PANEL PROFILES

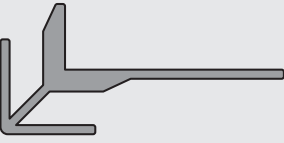
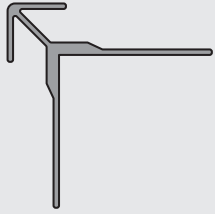
ŞEKİL DRAWING	KOD CODE	 mm	 mm	 cm <sup>4</sup>	 cm <sup>4</sup>	 kg/m	SAYFA PAGE
	<b>11-184</b>	19.60	8.30			0.140	594
	<b>11-185</b>	38.85	17.85			0.355	594
	<b>11-237</b>	28.00	28.00			0.165	594

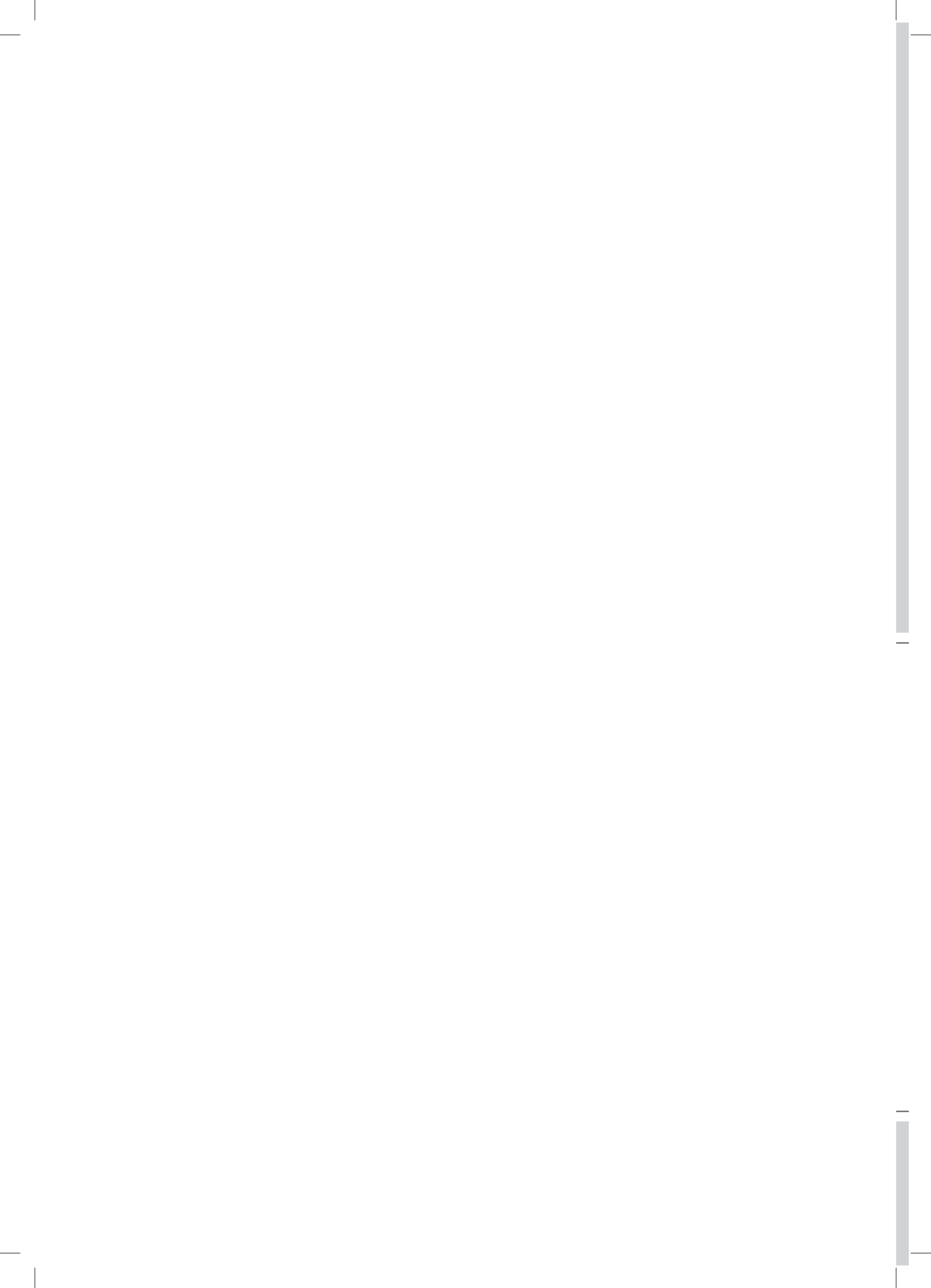

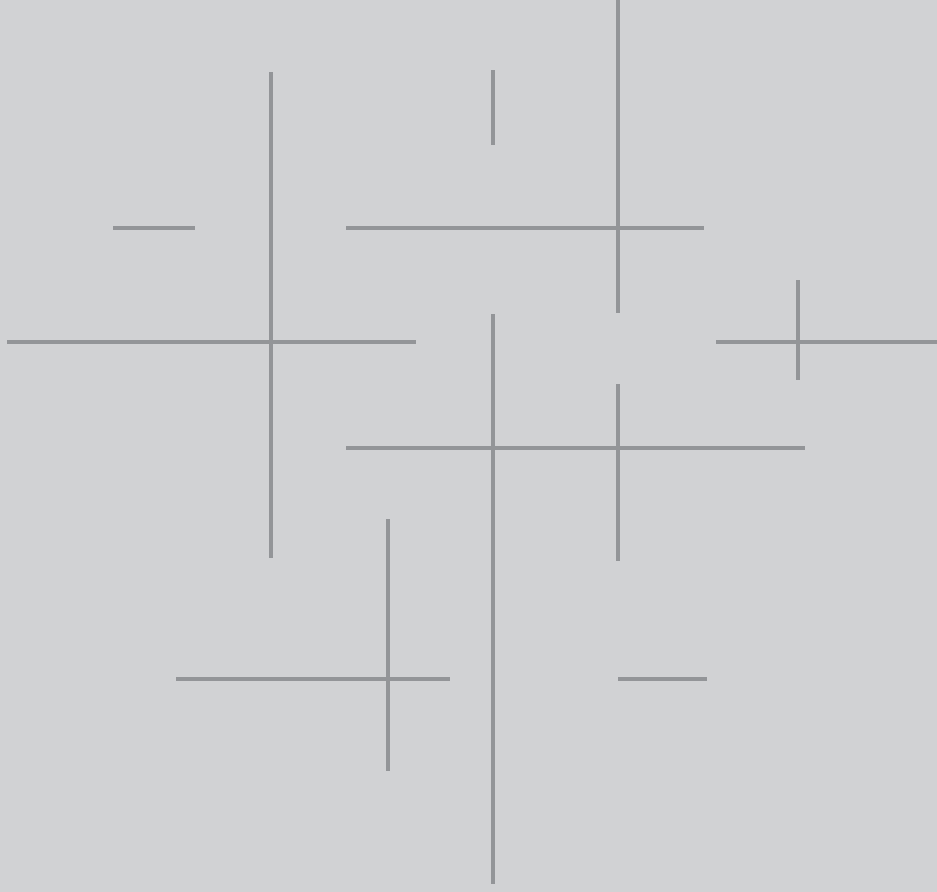

**KOMPOZİT PANEL PROFİLLERİ**  
COMPOSITE PANEL PROFILES

**151-160**  
PROFİL KESİT DETAYLARI  
PROFILE DETAILS DRAWINGS

## KOMPOZİT PANEL PROFİLLERİ

### COMPOSITE PANEL PROFILES

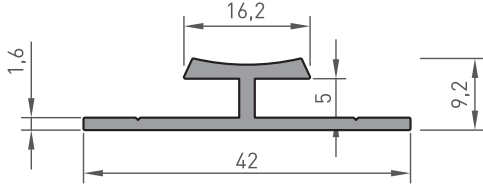

Profil Kodu	1045
Tanım:	Kompozit H
Ağırlık:	0.300 kg/m

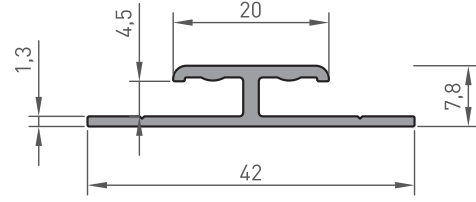

Profil Kodu	1046
Tanım:	Kompozit H
Ağırlık:	0.270 kg/m

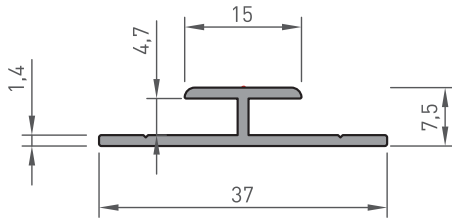

Profil Kodu	1000-171
Tanım:	Kompozit H
Ağırlık:	0.220 kg/m

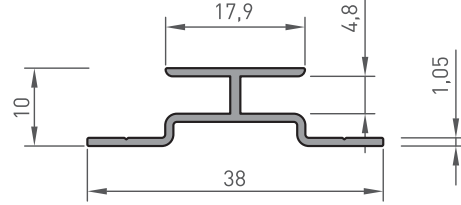

Profil Kodu	1047
Tanım:	Kompozit H
Ağırlık:	0.195 kg/m

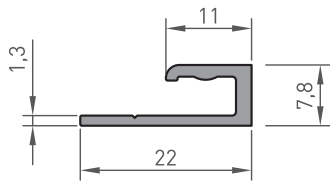

Profil Kodu	1048
Tanım:	Kompozit U
Ağırlık:	0.160 kg/m

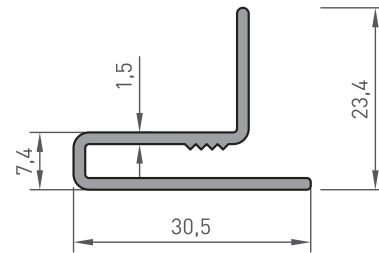

Profil Kodu	1049
Tanım:	Kompozit Levhaya Dönüş
Ağırlık:	0.300 kg/m



# KOMPOZİT PANEL PROFİLLERİ

## COMPOSITE PANEL PROFILES

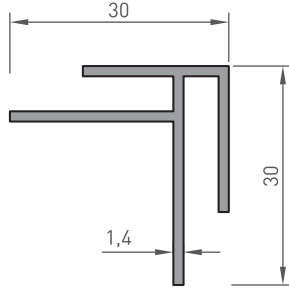

Profil Kodu	1000-135
Tanım:	30x30 Girintili Köşe
Ağırlık:	0.350 kg/m

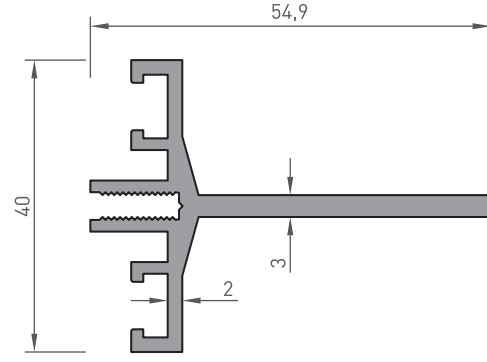

Profil Kodu	1000-131
Tanım:	Kompozit Kasa
Ağırlık:	0.820 kg/m

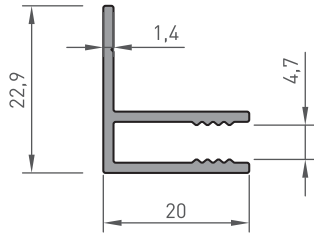

Profil Kodu	1000-136
Tanım:	Kompozit F
Ağırlık:	0.245 kg/m

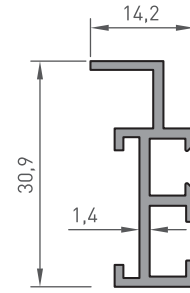

Profil Kodu	1000-132
Tanım:	Kompozit 4mm Kaset
Ağırlık:	0.275 kg/m

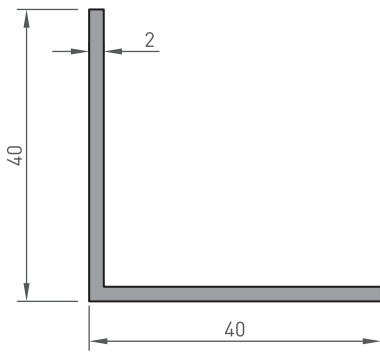

Profil Kodu	800-501
Tanım:	40x40 Köşebent
Ağırlık:	0.440 kg/m

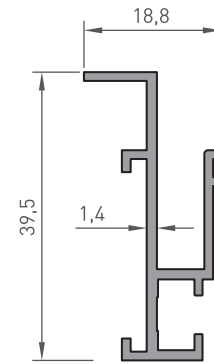

Profil Kodu	1000-133
Tanım:	Kompozit 6mm Kaset
Ağırlık:	0.350 kg/m

\*BELİRTİLEN AĞIRLIKLAR, TEORİK PRES ÇIKIŞ AĞIRLIKLARIDIR.  
\*BOYALI PROFİLLERDE AĞIRLIĞA %5 İLAVE EDİLMESİ GEREKLİDİR.

## KOMPOZİT PANEL PROFİLLERİ

### COMPOSITE PANEL PROFILES

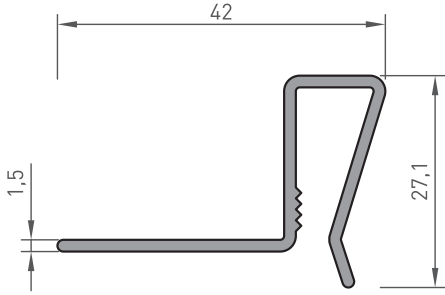

Profil Kodu	1000-140
Tanım:	Kompozit Levha Dönüş
Ağırlık:	0.495 kg/m

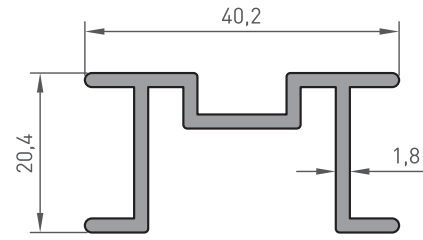

Profil Kodu	1000-141
Tanım:	Kompozit Profil
Ağırlık:	0.495 kg/m

## KOMPOZİT PANEL PROFİLLERİ

### COMPOSITE PANEL PROFILES

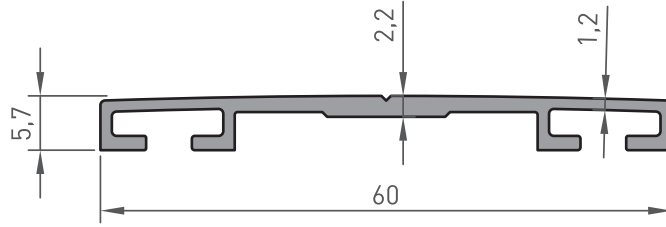

Profil Kodu	1000-143
Tanım:	Işıklık Kapak
Ağırlık:	0.370 kg/m

\*BELİRTİLEN AĞIRLIKLAR, TEORİK PRES ÇIKIŞ AĞIRLIKLARIDIR.  
\*BOYALI PROFİLLERDE AĞIRLIĞA %5 İLAVE EDİLMESİ GEREKLİDİR.

## KOMPOZİT PANEL PROFİLLERİ

### COMPOSITE PANEL PROFILES

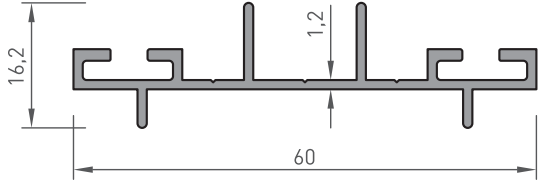

Profil Kodu	1000-146
Tanım:	Işıklık Alt
Ağırlık:	0.410 kg/m



Profil Kodu	800-309
Tanım:	Ø 8 Dolu Çubuk
Ağırlık:	0.140 kg/m

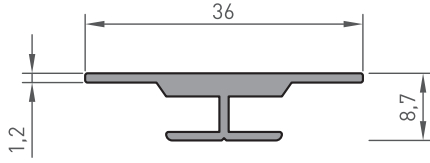

Profil Kodu	11-182
Tanım:	Kompozit Profili
Ağırlık:	0.260 kg/m

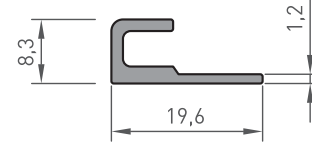

Profil Kodu	11-184
Tanım:	Kompozit Profili
Ağırlık:	0.140 kg/m

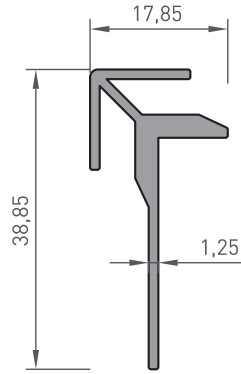

Profil Kodu	11-185
Tanım:	Kompozit Profili
Ağırlık:	0.335 kg/m

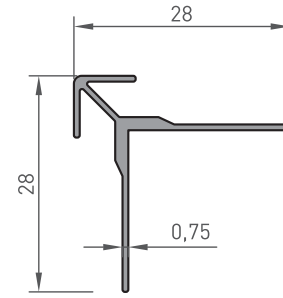

Profil Kodu	11-237
Tanım:	Kompozit Profili
Ağırlık:	0.165 kg/m

## KOMPOZİT PANEL PROFİLLERİ

### COMPOSITE PANEL PROFILES

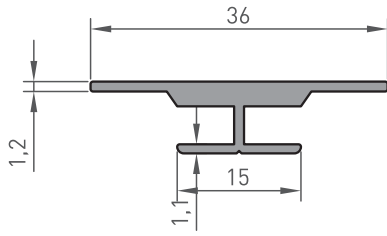

Profil Kodu	11-182
Tanım:	Kompozit Profili
Ağırlık:	0.260 kg/m

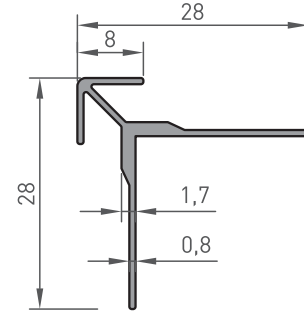

Profil Kodu	11-237
Tanım:	Kompozit Profili
Ağırlık:	0.165 kg/m

\*BELİRTİLEN AĞIRLIKLAR, TEORİK PRES ÇIKIŞ AĞIRLIKLARIDIR.  
\*BOYALI PROFİLLERDE AĞIRLIĞA %5 İLAVE EDİLMESİ GEREKLİDİR.

## KOMPOZİT PANEL PROFİLLERİ

### COMPOSITE PANEL PROFILES

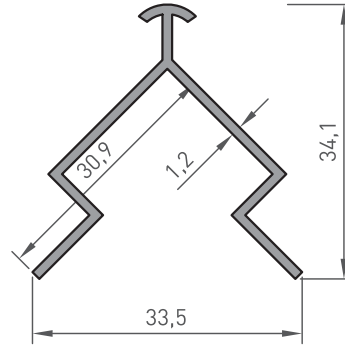

Profil Kodu	1000-177
Tanım:	Sinterflex Köşe
Ağırlık:	0.300 kg/m

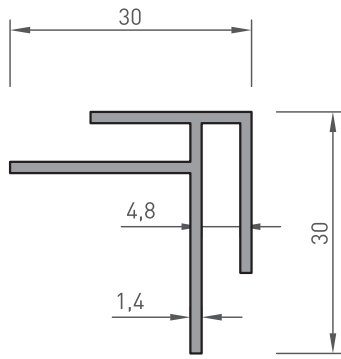

Profil Kodu	1000-135
Tanım:	30x30 Girintili Köşe
Ağırlık:	0.350 kg/m

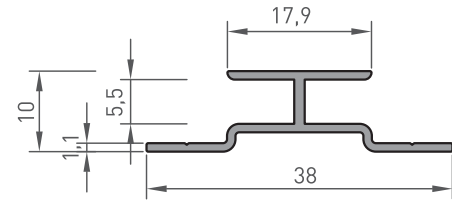

Profil Kodu	1000-359
Tanım:	Sinterflex "H"
Ağırlık:	0.230 kg/m

## KOMPOZİT PANEL PROFİLLERİ COMPOSITE PANEL PROFILES

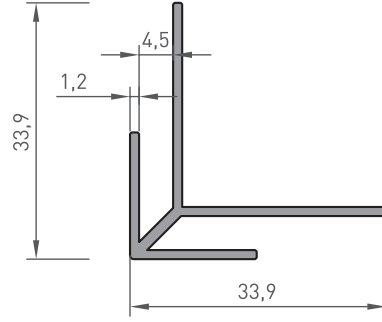

Profil Kodu	1000-275
Tanım:	Kompozit Profili
Ağırlık:	0.325 kg/m

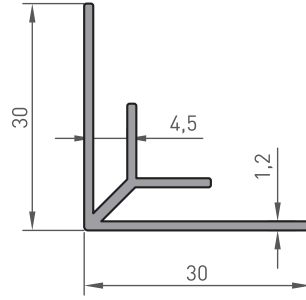

Profil Kodu	1000-274
Tanım:	Kompozit Profili
Ağırlık:	0.300 kg/m

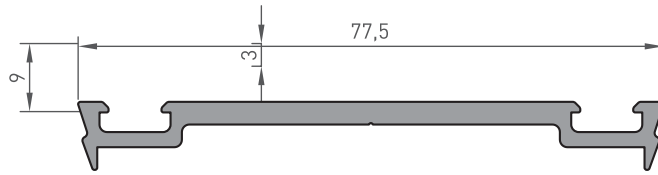

Profil Kodu	1000-258
Tanım:	Sahte Kayıt Montaj Aparatı
Ağırlık:	0.658 kg/m

\*BELİRTİLEN AĞIRLIKLAR, TEORİK PRES ÇIKIŞ AĞIRLIKLARIDIR.  
\*BOYALI PROFİLLERDE AĞIRLIĞA %5 İLAVE EDİLMESİ GEREKLİDİR.

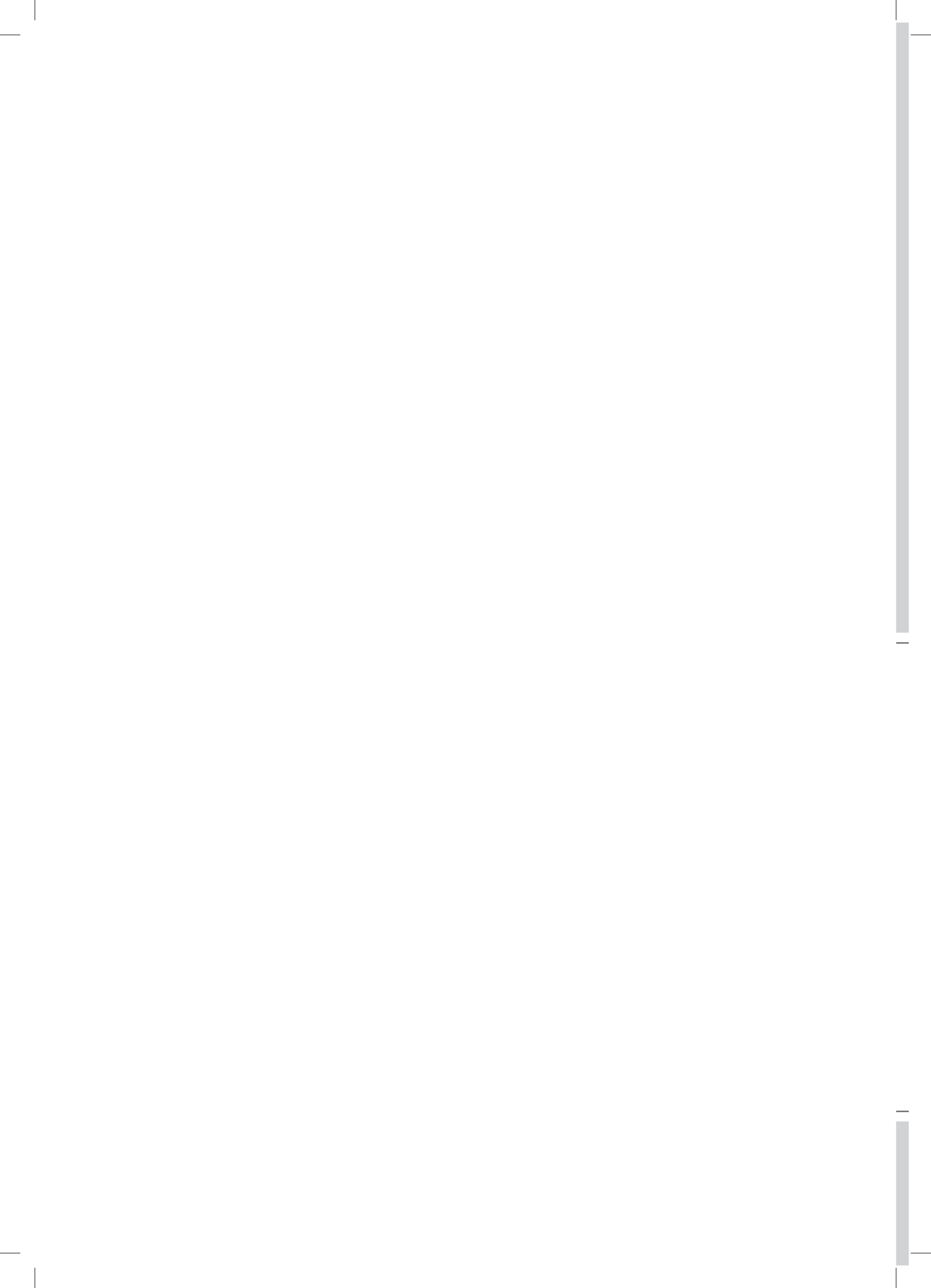



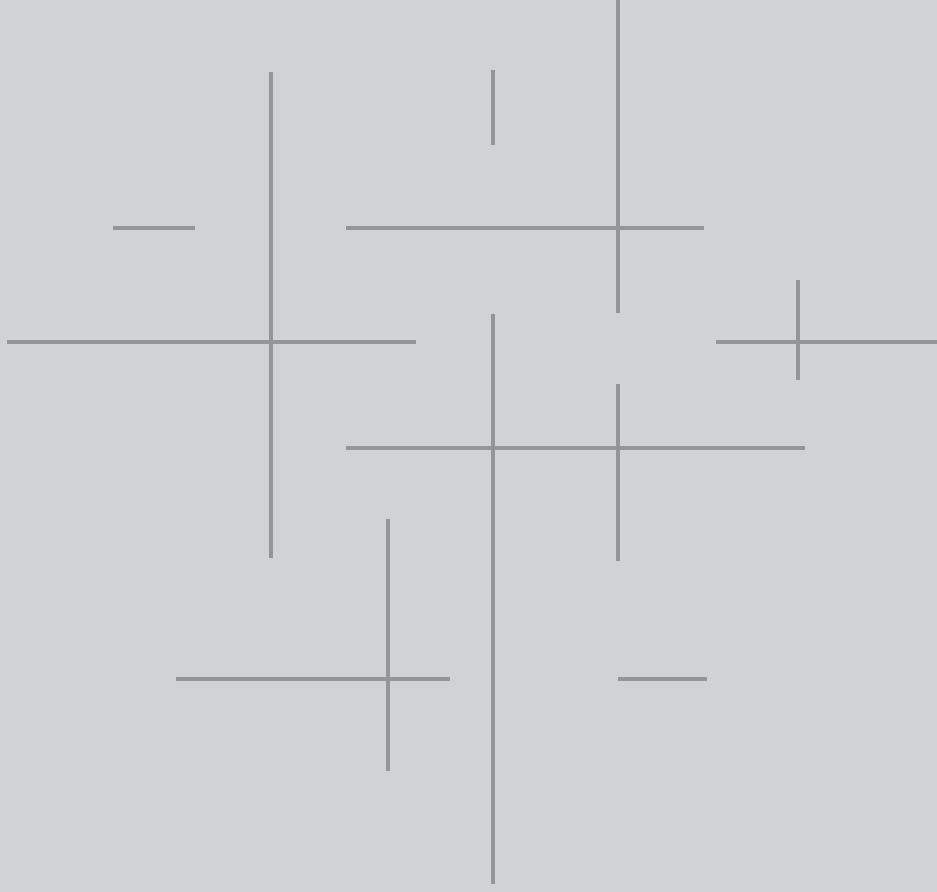

**KOMPOZİT PANEL PROFİLLERİ**  
COMPOSITE PANEL PROFILES

**161-165**  
SİSTEM DETAYLARI  
SYSTEM DETAILS

# KOMPOZİT PANEL PROFİLLERİ

## COMPOSITE PANEL PROFILES

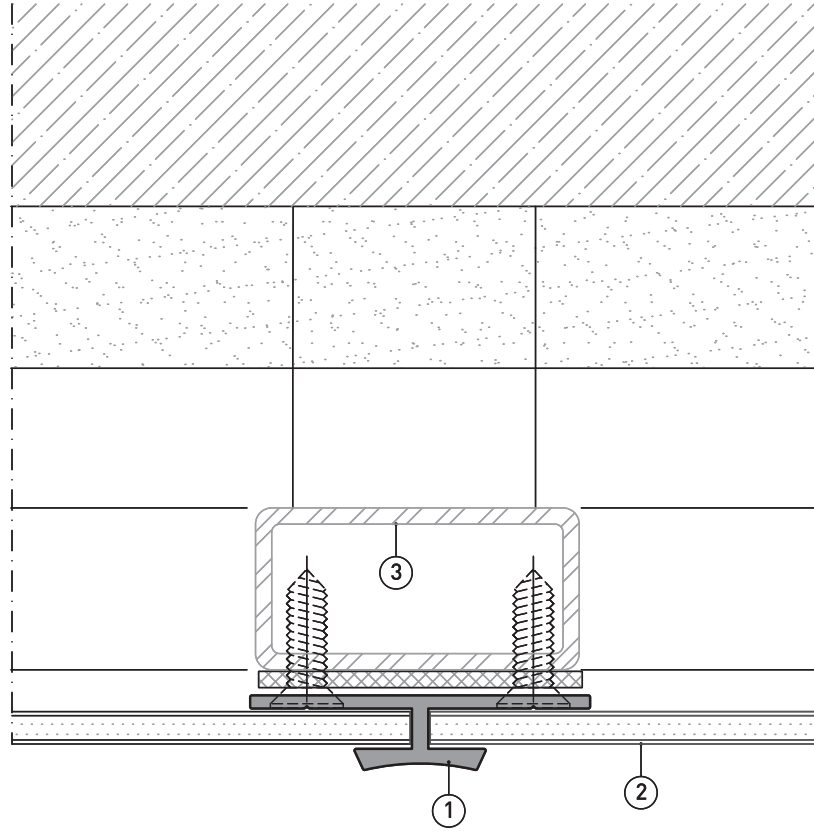
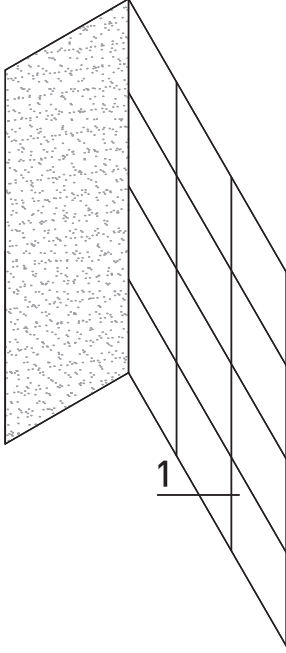

### 1- DETAY

- ① — 1045- KOMPOZİT PROFİLİ
- ② — KOMPOZİT LEVHA
- ③ — KÖRKASA

# KOMPOZİT PANEL PROFİLLERİ

## COMPOSITE PANEL PROFILES

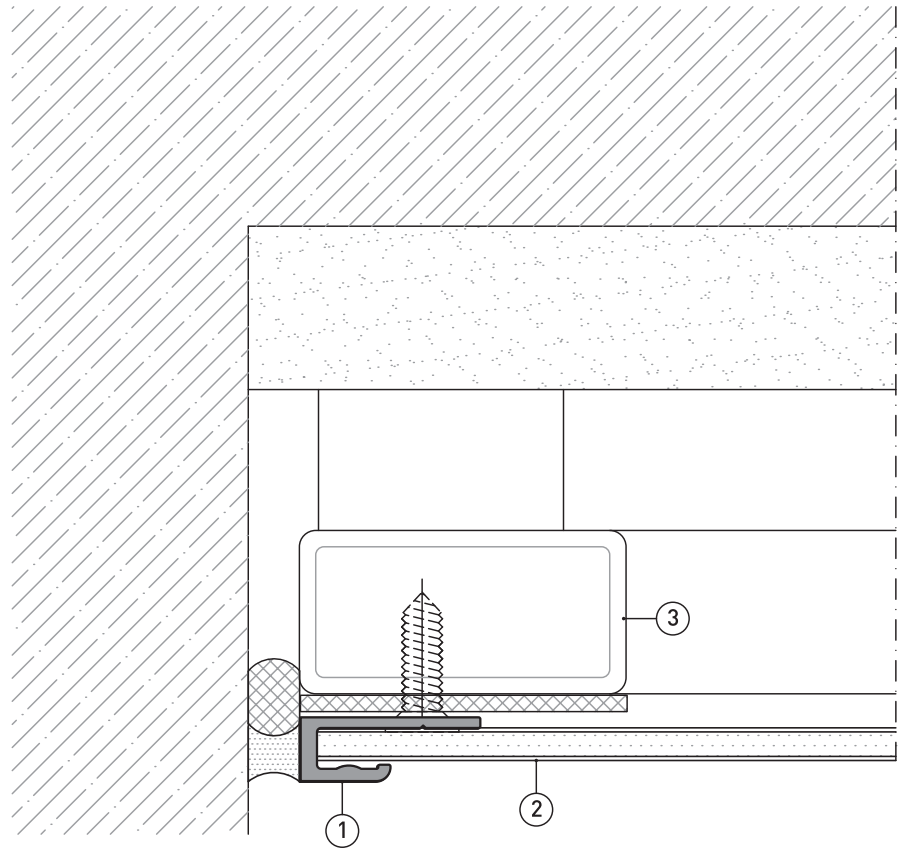
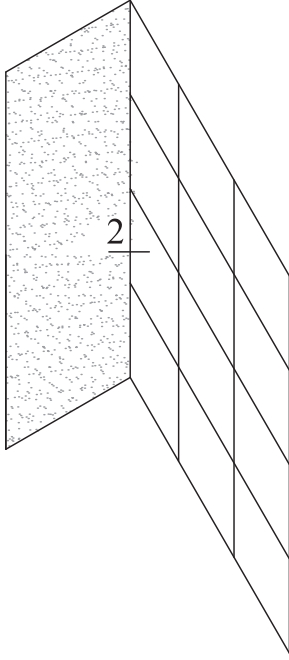

### 2- DETAY

- ①— 1048- KOMPOZİT PROFİLİ
- ②— KOMPOZİT LEVHA
- ③— KÖRKASA

# KOMPOZİT PANEL PROFİLLERİ

## COMPOSITE PANEL PROFILES

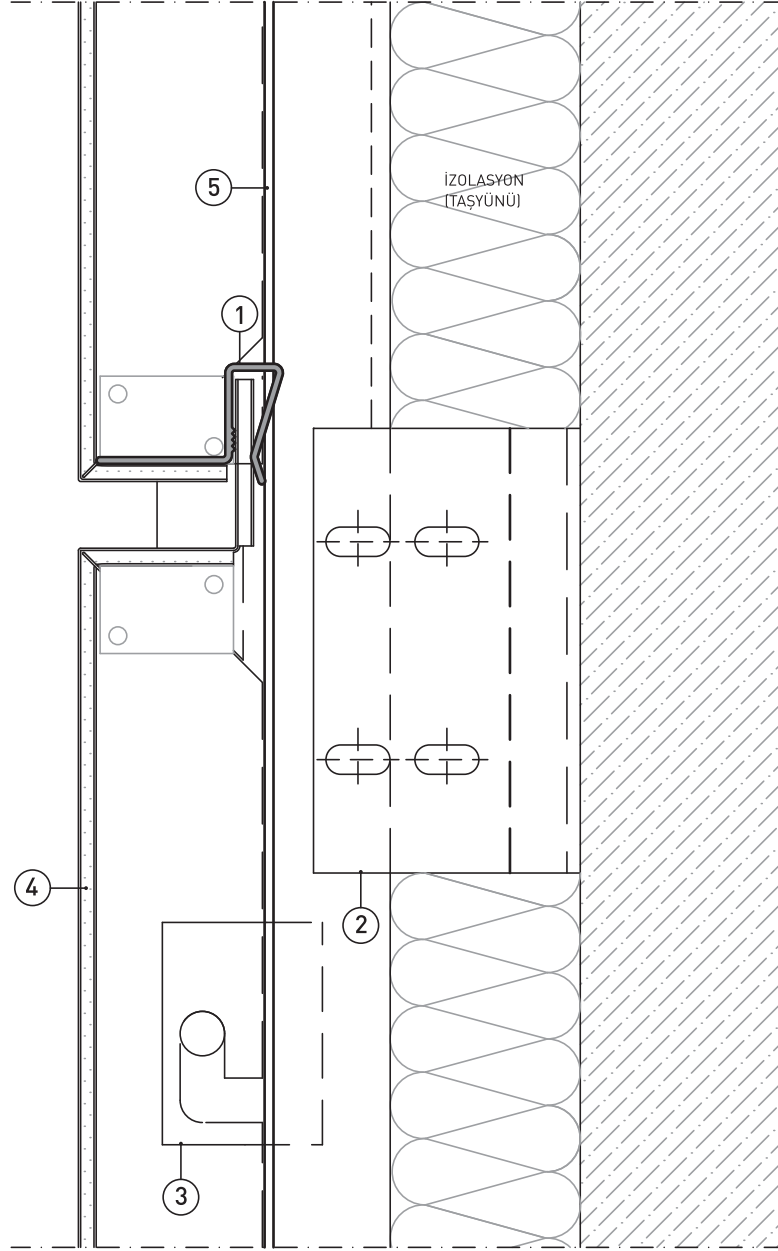

### 4- DETAY

- ①— 1000-140 KOMPOZİT LEVHA DÖNÜŞ PROFİLİ
- ②— 1000-142 KOMPOZİT U PROFİLİ
- ③— 1000-144 KOMPOZİT BAĞLANTI
- ④— KOMPOZİT LEVHA
- ⑤— 1000-143 KOMPOZİT KASA PROFİLİ

# KOMPOZİT PANEL PROFİLLERİ

## COMPOSITE PANEL PROFILES

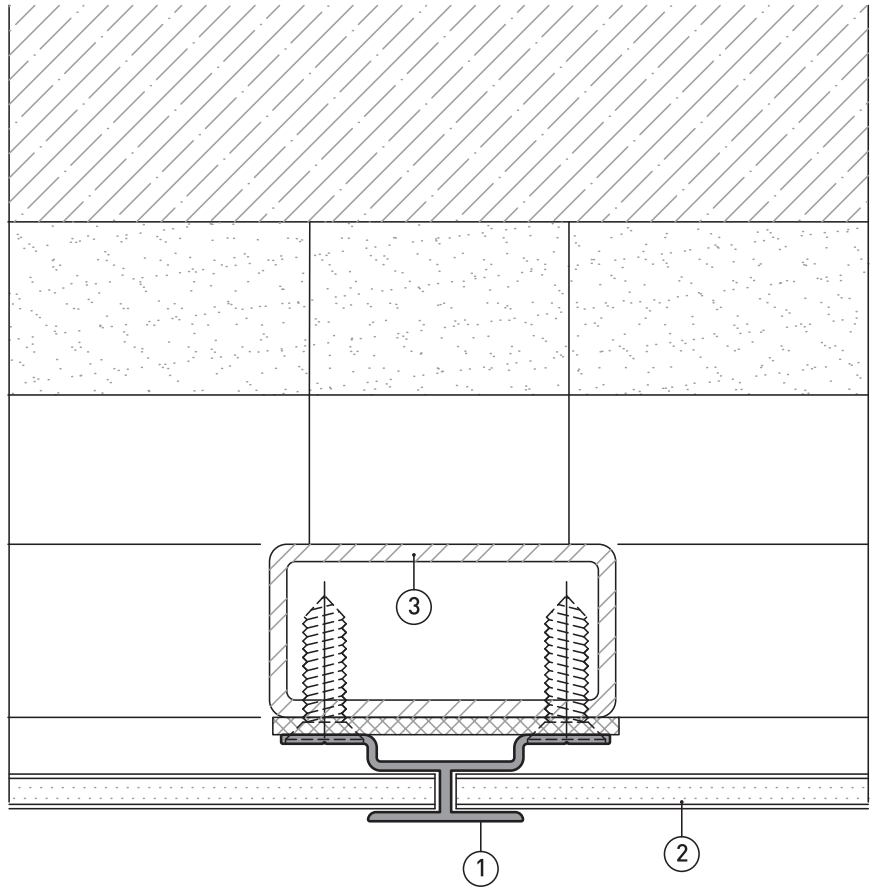
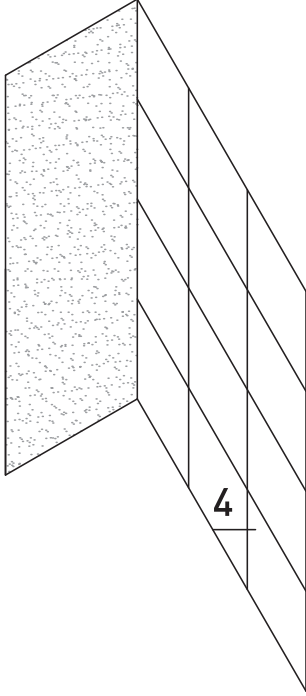

### 4- DETAY

- ①- 1047- KOMPOZİT PROFİLİ
- ②- KOMPOZİT LEVHA
- ③- KÖRKASA











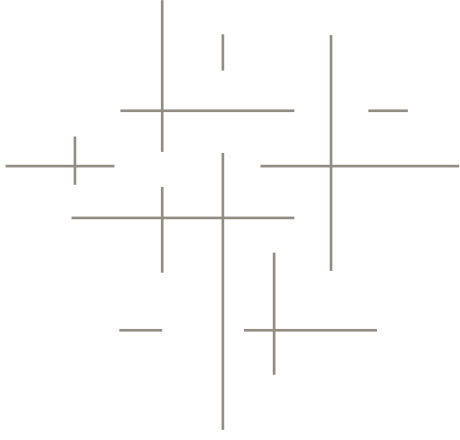

Hacı Sabancı Organize Sanayi Bölgesi  
Atatürk Bulvarı No: 41  
Sarıçam / ADANA / TÜRKİYE  
Telefon : +90 322 394 32 97  
Fax : +90 322 394 36 47  
Email : mekaline@mekaline.com.tr  
web : [www.mekaline.com.tr](http://www.mekaline.com.tr)