

keyifli anlarınızı
oluřturun...

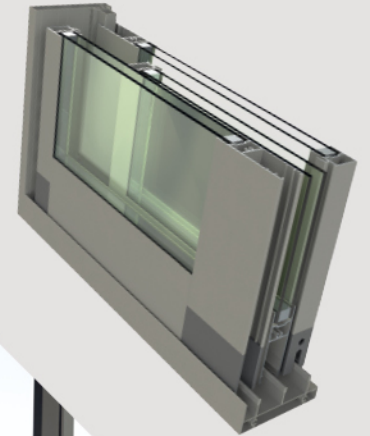

temizlenebilir
giyotinsistem
sürmesistem
kışbahçesi

MEKA
LINE

www.mekaline.com.tr

Hakkımızda / About us



Mekaline Alüminyum 1992 yılında alüminyum ekstrüzyon kalıp sektörü ile işe başlayıp her geçen gün gelişerek kalite ve üretimini arttırarak alüminyum profil üretimi ile yoluna devam etmektedir. Yeni ve modern teknoloji ile donatılmış tesisimiz 40.000 m² üzerine kurulmuş olup, 30.000 m² kapalı alan içerisinde üretimine devam etmektedir.

Haziran 2011 Tarihinde 1100 tonluk alüminyum pres hattı, 2015 yılında ise 1600 tonluk pres hattını devreye alarak Adana Hacı Sabancı Organize Sanayi Bölgesinde faaliyetlerine başlamıştır.

Entegre yönetim sistemi ile uluslararası kalite standartlarında üretim yapmakta, güvenilir satış politikası ile müşteri taleplerine hızlı ve ekonomik çözümler sunmaktadır.

10.000 ton üretim kapasiteli dikey elektrostatik boyama hattı, 600 ton kapasiteli ahşap kaplama hattı, 12.000 ton kapasiteli eloksal yüzey kaplama hattına sahiptir.

Tesisimiz kalıp İhtiyacını kendi bünyesinde karşılamakta olup 12.000 binin üzerinde olan ürün çeşitliliği ile İnşaat, Mobilya ve Reklam, Otomotiv, Enerji, Elektrik-Elektronik, Sektörlerinde faaliyet göstermektedir, ayrıca müşterilerimizin taleplerine yönelik de hizmet vermekte olup, yüksek kalitede hizmetini sürdürmektedir.

Firmamız bu kalite ile yetinmeyip daha yüksek yerler hedefleyerek yılların vermiş olduğu bilgi ve deneyimli kadrosu ile en üst düzeyde teknolojiyi kullanarak en güzel hizmeti verebilmenin gayreti içerisinde.

Our company, Mekaline Aluminum, started to work in the aluminum extrusion mold sector in 1992 and continues its way with aluminum profile production by increasing its quality and production day by day. Our facility, equipped with the new and modern technology, was established on 40.000 sqm and continues its production in a closed area of 30.000 sqm.

It started its activities in Adana Hacı Sabancı Organize Sanayi Bölgesi by putting into use 1100 tons of aluminum press line in June 2011 and 1600 tons of press line in 2015.

It produces in international quality standards with its integrated management system and it offers fast and economical solutions to customer demands with the reliable sales policy.

It has a vertical electrostatic painting line with a production capacity of 10,000 tons, a wood coating line with a capacity of 600 tons, an anodized surface coating line with a capacity of 12,000 tons.

Our facility meets the mold needs within its own structure, and it operates in the Construction, Furniture and Advertising, Automotive, Energy, Electric-Electronics Sectors with its product range of over 12,000 thousand, and also provides services for the demands of our customers and maintains its high quality service.

Our company strives to provide the best service by using the highest level of technology with the knowledge and experienced staff of years, by targeting higher places because it is not satisfied with this quality.



Temizlenebilir Giyotin Sistem



Temizlenebilir Giyotin Sistem;

Hareketli Küpeşte, dikey olarak birbirinin paralelinde hareket ederek açılıp kapanan cam panellerden oluşan ve otomatik olarak kumanda edilebilen bir cam kapama sistemidir.

Görüş açısından herhangi bir kayıp yaşanmaması nedeniyle özellikle kafe, restoran, otel, düğün salonu gibi ticari mekanlarda, kış bahçesi, veranda gibi konutsal alanlarda ve tamamen içten temizlenebilme özelliğiyle balkon, teras gibi açık mekanların kapatılmasında tercih edilen estetik, fonksiyonel ve kullanışlı çözümlerdir.





MOTOR KUTUSU

KODU	GRAMAJI
MG-200	2,540 Kg/m



**MOTOR KUTUSU
KAPAĞI**

KODU	GRAMAJI
MG-201	0,810 Kg/m



ALT KASA

KODU	GRAMAJI
MG-207	1,280 Kg/m

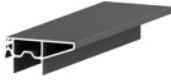

**TUTAMAKLI
KENET BAZA**

KODU	GRAMAJI
MG-212	0,930 Kg/m



KENETLİ BAZA

KODU	GRAMAJI
MG-211	0,670 Kg/m



KÜPEŞTE BAZASI

KODU	GRAMAJI
MG-210	0,550 Kg/m



KÜPEŞTE

KODU	GRAMAJI
MG-209	0,460 Kg/m

**TEK CAM ÇITASI**

KODU	GRAMAJI
MG-213	0,270 Kg/m

**DİKEY BAZA**

KODU	GRAMAJI
MG-208	0,930 Kg/m

**KANAT**

KODU	GRAMAJI
MG-206	1,560 Kg/m

**SON KAPATMA**

KODU	GRAMAJI
MG-204	0,950 Kg/m

**YAN DİKME**

KODU	GRAMAJI
MG-202	1,740 Kg/m

**ORTA DİKME**

KODU	GRAMAJI
MG-203	0,650 Kg/m

**YAN DİKME ÇITA**

KODU	GRAMAJI
MG-205	0,100 Kg/m



Temizlenebilir Giyotin Sistem Dişli Seti

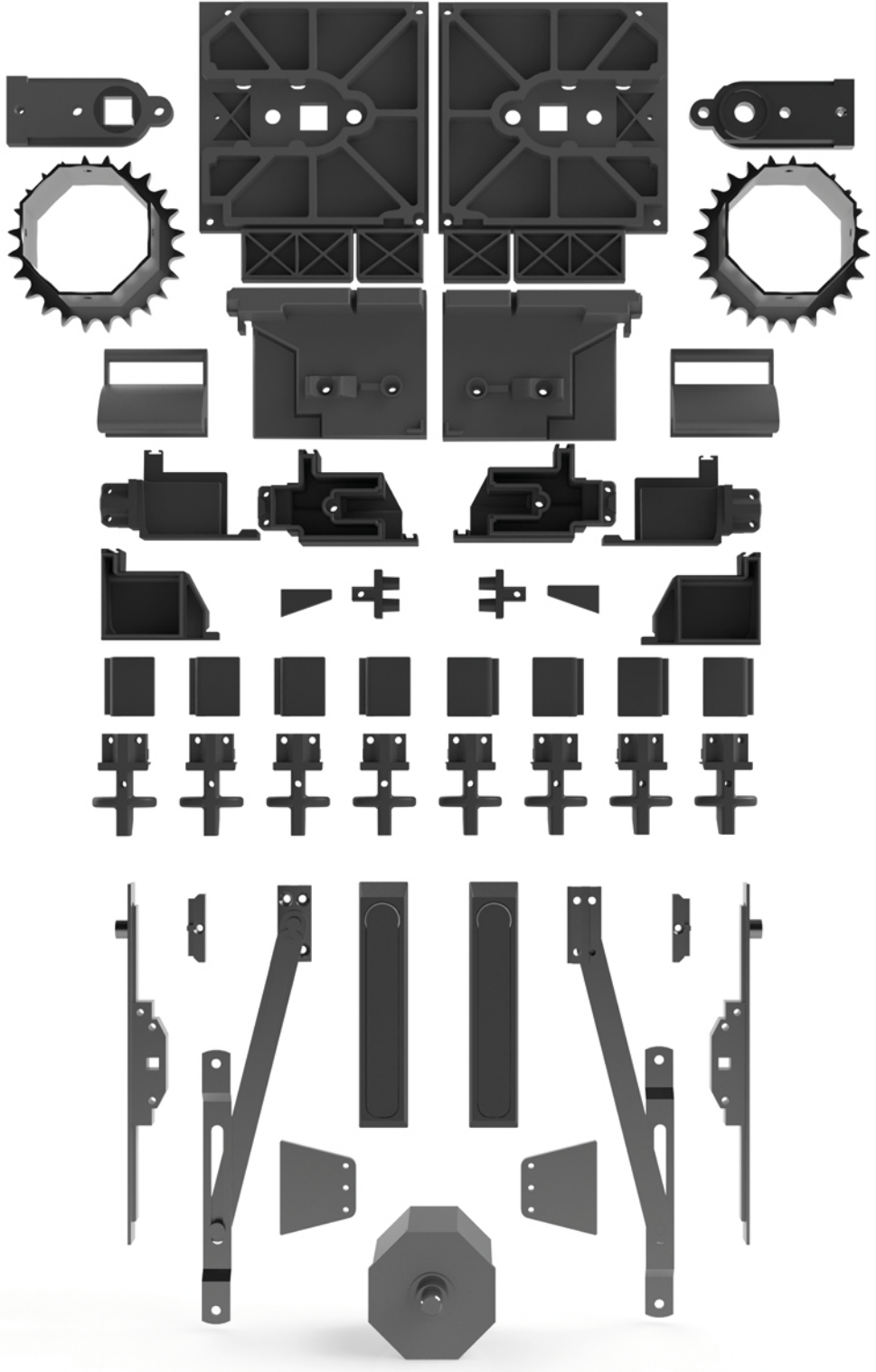

Temizlenebilir Giyotin Sistem

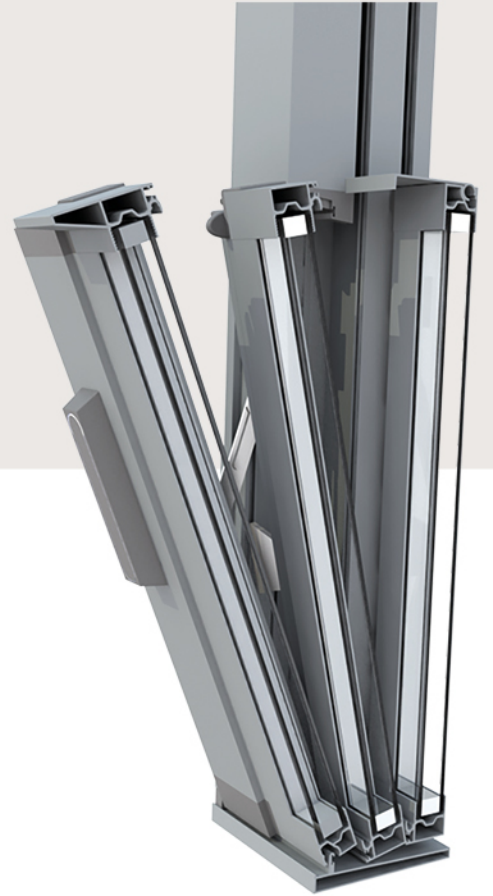

Temizlenebilir Giyotin Sistem

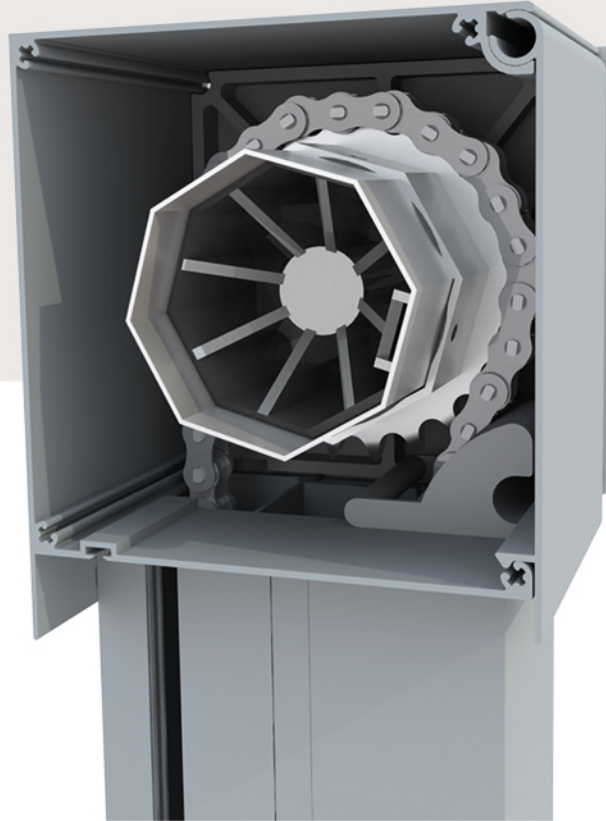
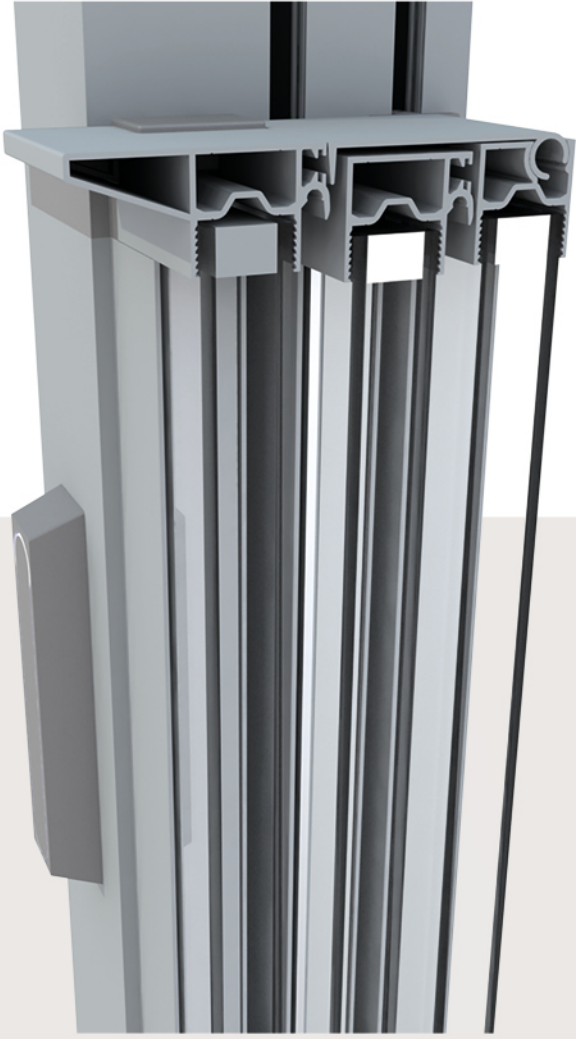

Temizlenebilir Giyotin Sistem

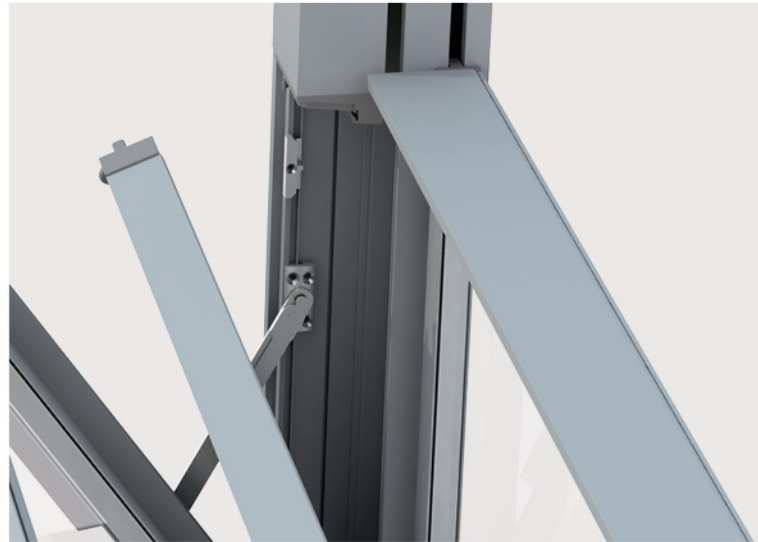
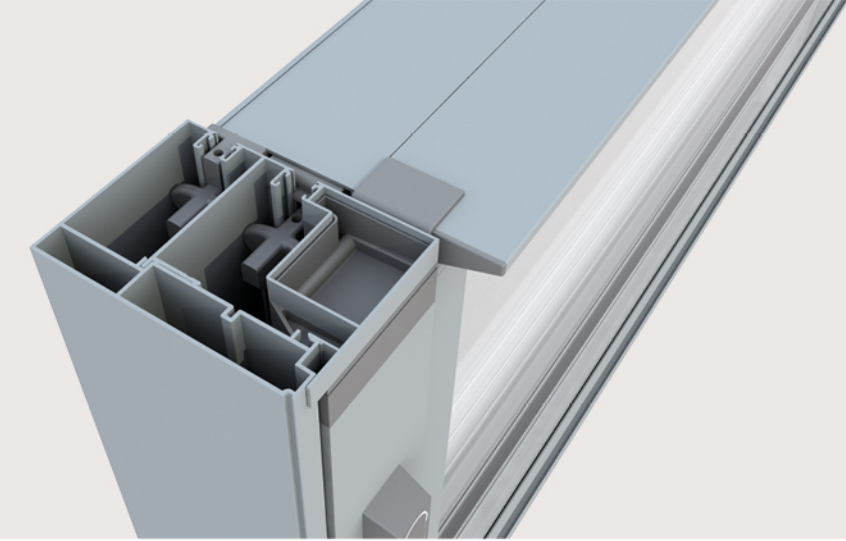
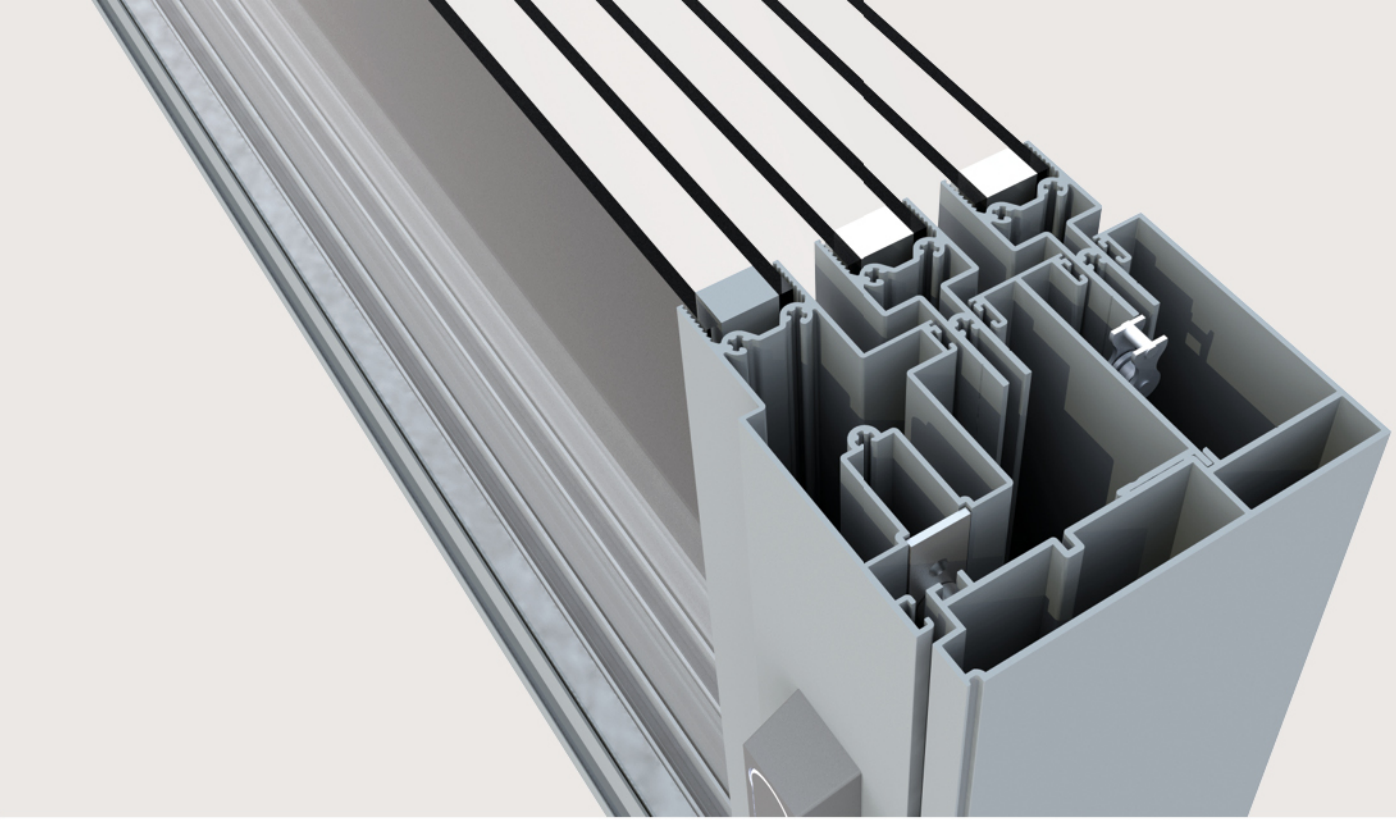

Sürme Sistem

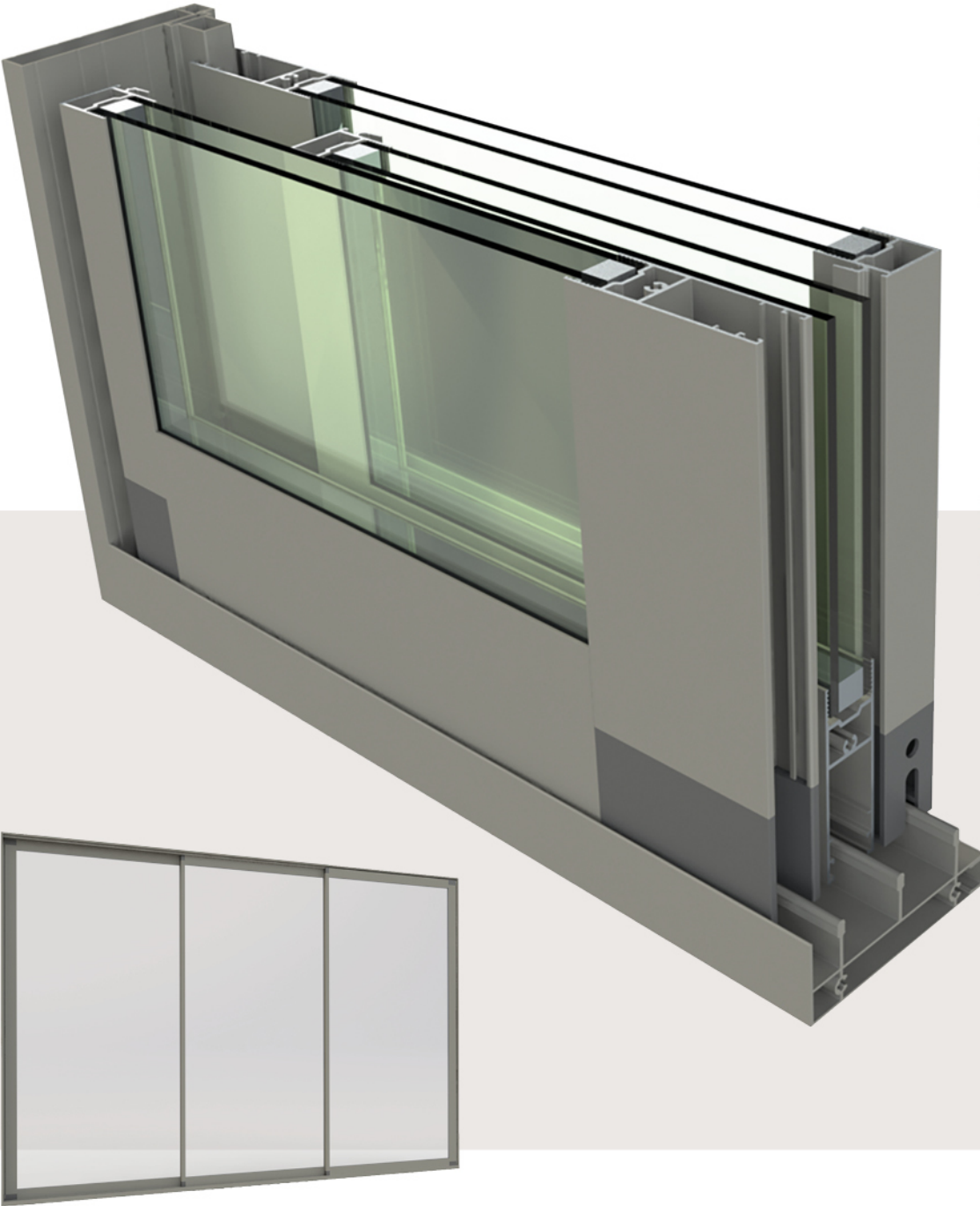

Sürme Sistem;

Isıcamlı sürme sistemini evlerde, balkonlarda, restoranlarda, kış bahçelerinde tercih edebilirsiniz. Isıcamlı sürme serisinde; Camların ısıcamlı ve çift taraflı temperli olması daha etkin yalıtım, güvenlik ve dolayısıyla enerji tasarrufu sağlamaktadır. Camlar çeşitli renklerde ve özellikleri ile yalıtım performansını yükseltir.

Dört mevsim daha konforlu ve daha yalıtımlı mekânlarda yaşamanızı kolaylaştırır. Hem güvenlik hem de kırılmaya karşı önlem olarak ısıcam bünyesinde temperli olarak emniyet ve güvenlik camları kullanılmaktadır.



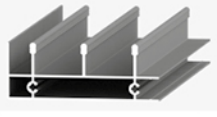

**ALT ÜST
KASA 3'LÜ**

KODU	GRAMAJI
MS-100	1,240 Kg/m



**YAN DİKME
3'LÜ**

KODU	GRAMAJI
MS-101	0,790 Kg/m

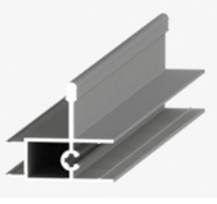

EK RAY

KODU	GRAMAJI
MS-102	0,500 Kg/m

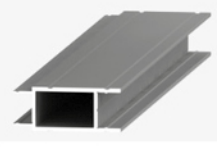

EK YAN DİKME

KODU	GRAMAJI
MS-103	0,385 Kg/m



KASA KAPAK

KODU	GRAMAJI
MS-104	0,125 Kg/m



YATAY BAZA

KODU	GRAMAJI
MS-105	0,890 Kg/m

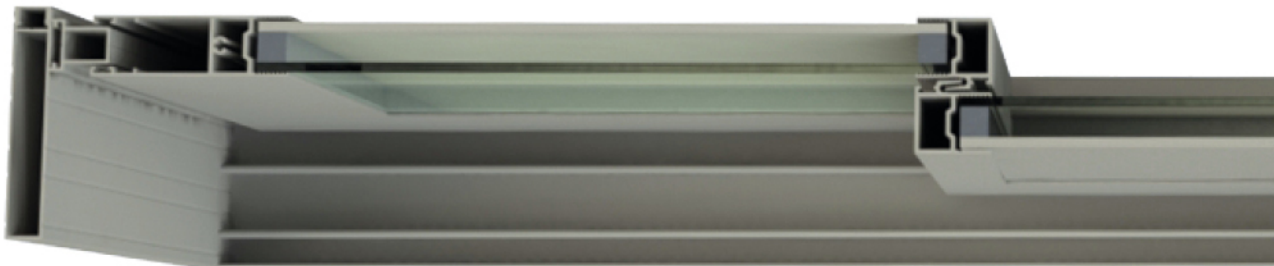

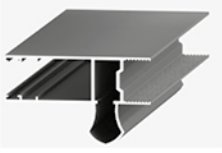

**ÇEKME DİKEY
BAZA**

KODU	GRAMAJI
MS-106	0,980 Kg/m

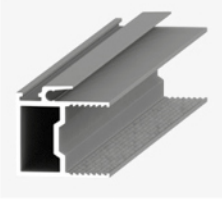

**KENET
DİKEY BAZZA**

KODU	GRAMAJI
MS-107	0,540 Kg/m

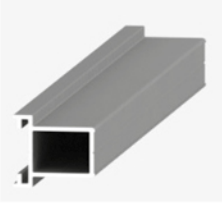

**KİLİT
KARŞILIĞI**

KODU	GRAMAJI
MS-108	0,320 Kg/m



**TAKVİYELİ
KANAT**

KODU	GRAMAJI
MS-109	0,710 Kg/m

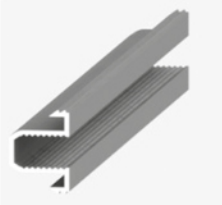

**TEK CAM
ÇİTASI**

KODU	GRAMAJI
MS-110	0,255 Kg/m



Sürme Sistem

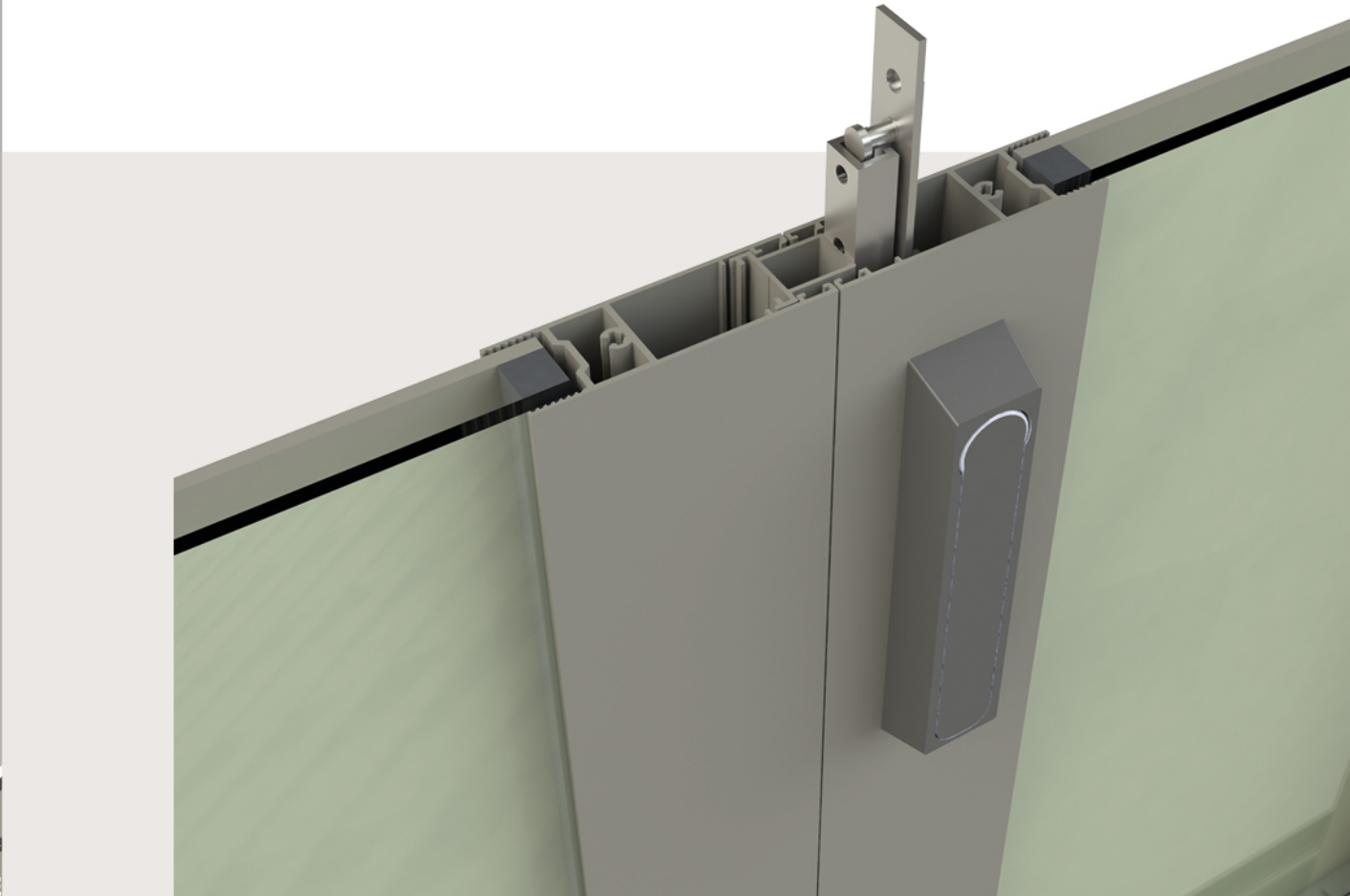
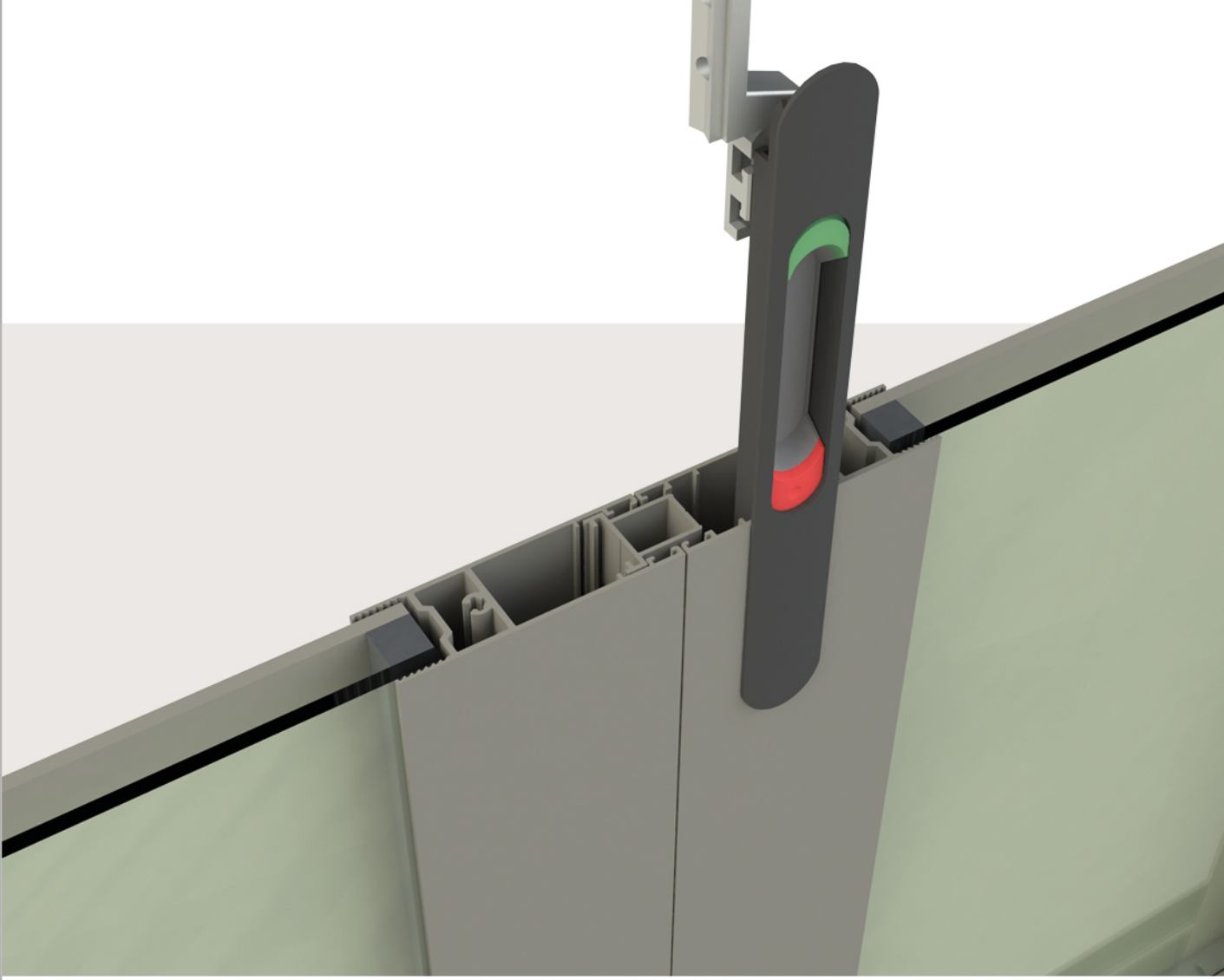

ME
LINE

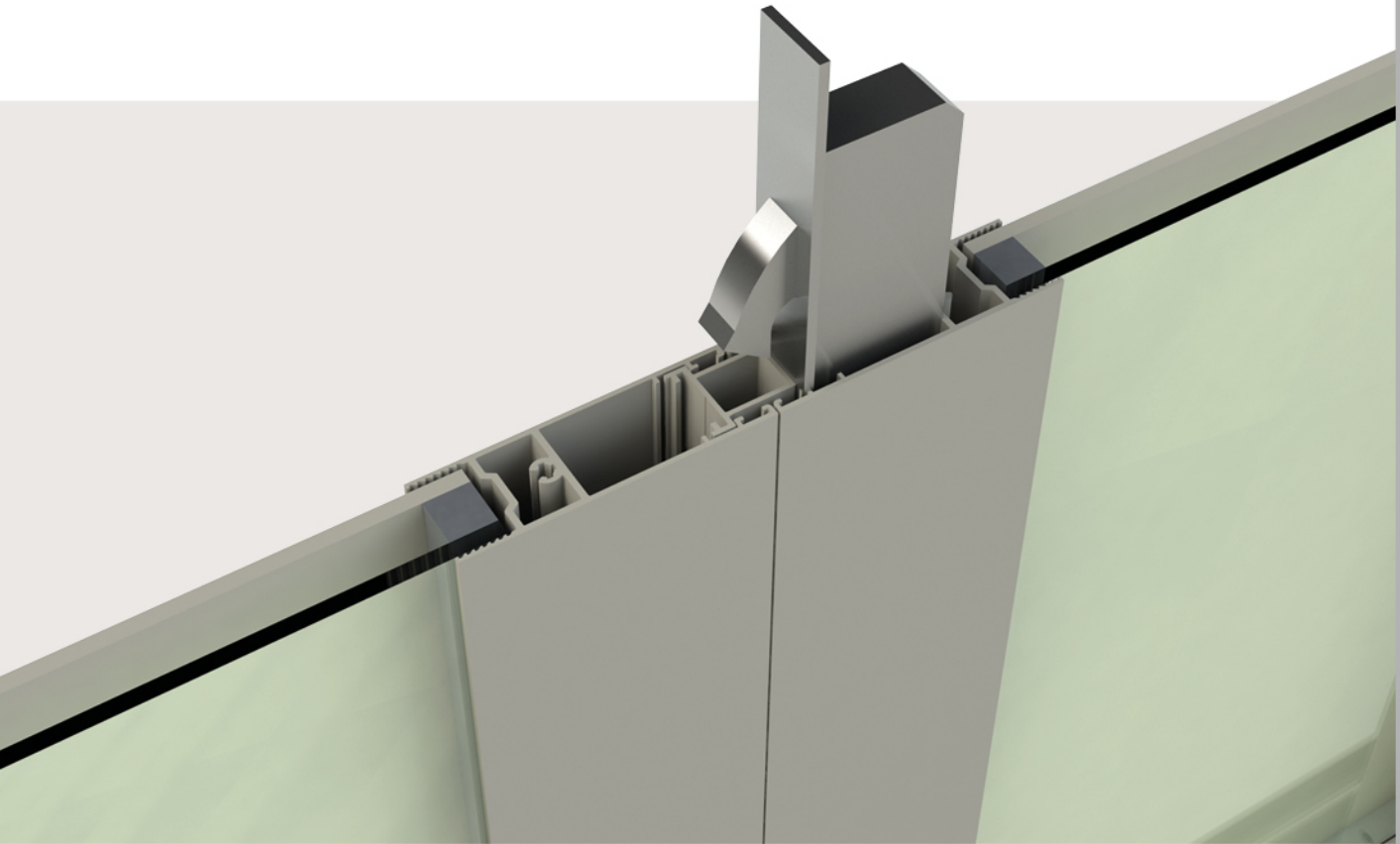

Sürme Sistem Aksesuarları

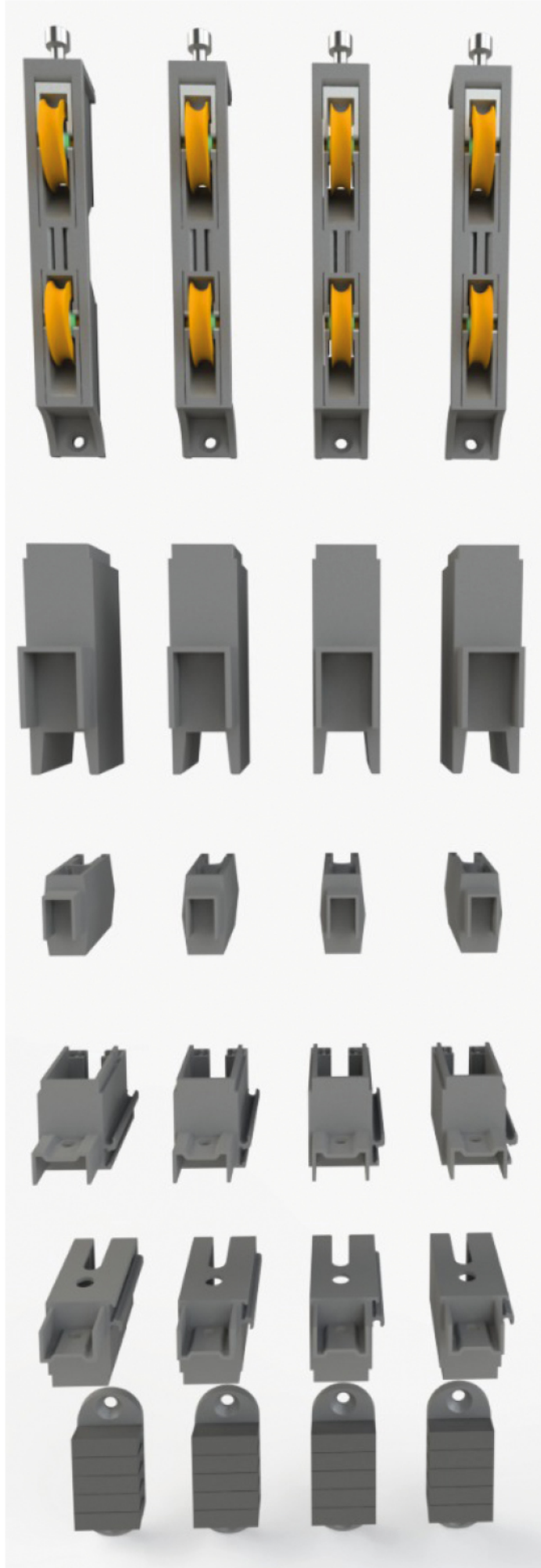

Kış Bahçesi

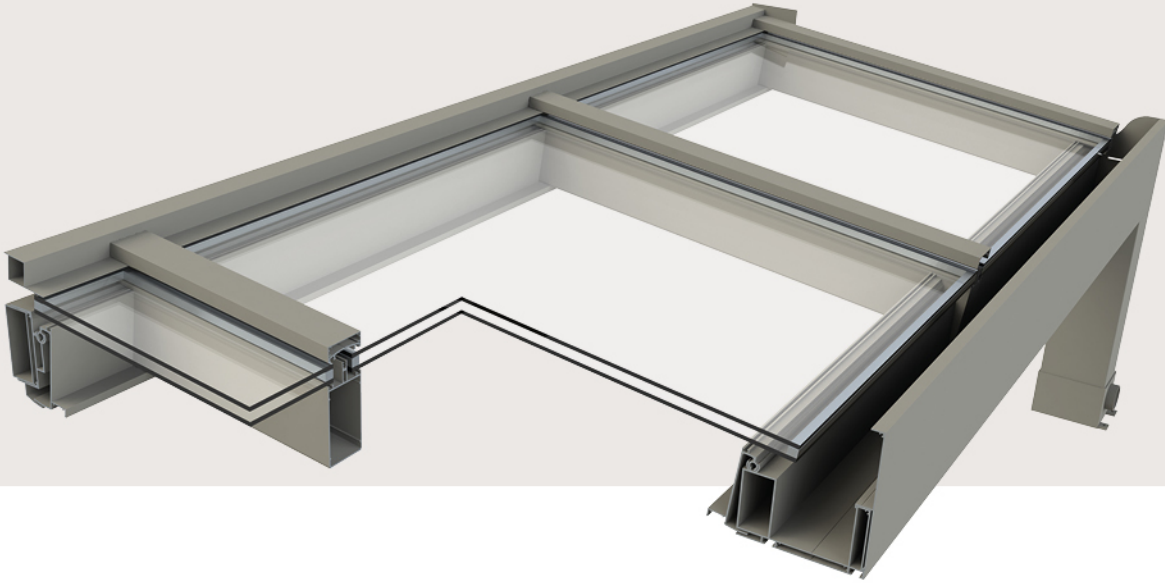

Kış Bahçesi Sistemi Tanım;

Alüminyum kış bahçesi sistemi genellikle evlerde, restoranlarda, kafe de ve diğer ticari işletmelerde kullanılır. Doğal yaşam alanı ve mevcut alanı genişletmek için ideal bir seçenektir.

Alüminyum kış bahçesi, ekstra yaşam alanı ve estetik bir tasarım sunar. Dayanıklı ve pratik yapısıyla uzun yıllar boyunca konforlu bir yaşam alanı sunmaktadır.





DİKME PROFİL

KODU GRAMAJI

MKB-300 2,745 Kg/m

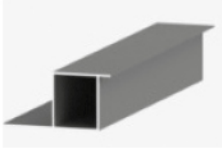

**ARKA MAHYA
KAPAMA**

KODU GRAMAJI

MKB-301 0,585 Kg/m



**AYARLI ARKA
MAHYA**

KODU GRAMAJI

MKB-302 2,230 Kg/m



**AYARLI ÖN
ARKA ADAPTÖR**

KODU GRAMAJI

MKB-303 1,580 Kg/m

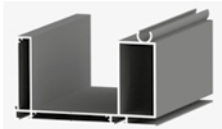

**AYARLI ÖLÜK
PROFİLİ**

KODU GRAMAJI

MKB-304 4,760 Kg/m

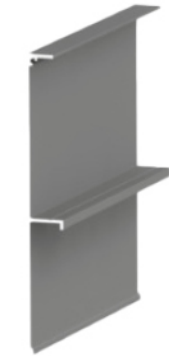

**ÖLÜK DÜZ
YÜKSELTME**

KODU GRAMAJI

MKB-305 1,340 Kg/m



**OLUKLU OVAL
YÜKSELTME**

KODU	GRAMAJI
MKB-306	1,435 Kg/m



**LEDLİ CAM
TAŞIYICI**

KODU	GRAMAJI
MKB-307	2,430 Kg/m



BASKI PROFİLİ

KODU	GRAMAJI
MKB-308	0,550 Kg/m



**ORTA KAPAK
PROFİLİ**

KODU	GRAMAJI
MKB-309	0,490 Kg/m

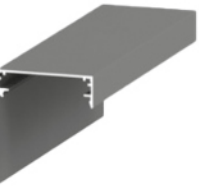

**BİTİM KAPAK
PROFİLİ**

KODU	GRAMAJI
MKB-310	0,710 Kg/m



LED PROFİLİ

KODU	GRAMAJI
MKB-311	0,420 Kg/m



Hacı Sabancı Organize Sanayi Bölgesi
Atatürk Bulvarı No: 41
Sarıçam / ADANA / TÜRKİYE
Telefon : +90 322 394 32 97
Email : mekaline@mekaline.com.tr



www.mekaline.com.tr